



ANGEL™

OPERATORS MANUAL

⚠ WARNING

The Angel is not a toy. Careless or improper use, including failure to follow instructions in the Operator's Manual, could cause death or serious injury. Paintball industry standard basic safety equipment protection designed specifically for paintball games must be worn by user and any person within 200 yards (163 meters). Do not shoot at a person at close range. Observe all local laws, regulations, and guidelines. Use only on professional paintball fields where codes of safety are strictly enforced. Use compressed air only. DO NOT USE CO₂. Use .68-caliber paintballs only. Read Operator's Manual before use and comply with all safety instructions.

The ANGEL™ is a registered trade mark. Design rights & all rights reserved.
 All patterns drawings photographs instructions or manuals remain the intellectual property of the manufacturer. Patents pending. All rights will be strictly enforced.

<u>Important Safety Guidelines</u>	<u>3</u>
<u>Operating Instructions</u>	<u>4</u>
<u>Charging</u>	<u>4</u>
<u>Propellant Air / Nitrogen Supply</u>	<u>5</u>
<u>Switching the ANGEL LCD ON</u>	<u>5</u>
<u>Fitting the Intellifeed (Optional accessory)</u>	<u>5</u>
<u>Bolt removal Rotabreech</u>	<u>6</u>
<u>Velocity adjustment</u>	<u>6</u>
<u>External Electronic LCD Menus</u>	<u>7</u>
<u>Back light feature</u>	<u>7</u>
<u>Temperature feature</u>	<u>7</u>
<u>Cycles (Total shots feature)</u>	<u>7</u>
<u>Trip (Shot counter feature)</u>	<u>7</u>
<u>Faults (Self diagnostics feature)</u>	<u>7</u>
<u>ID number feature</u>	<u>7</u>
<u>ROF (Rate of fire actually achieved by user feature)</u>	<u>7</u>
<u>MROF (Maximum rate of fire feature)</u>	<u>8</u>
<u>Timer (Game timer feature)</u>	<u>8</u>
<u>Dwell feature</u>	<u>8</u>
<u>Vibes (Vibrator alarm feature)</u>	<u>8</u>
<u>Mode feature (Style of shooting)</u>	<u>8</u>
<u>Battery Feature</u>	<u>8</u>
<u>Pin number feature</u>	<u>8</u>
<u>Internal Tournament Electronic LCD</u>	<u>9</u>
<u>Menus Modes features</u>	<u>9</u>
<u>Dwell feature</u>	<u>9</u>
<u>MROF (maximum rate of fire limit)</u>	<u>10</u>
<u>Temperature feature</u>	<u>10</u>
<u>Pin number (setting)</u>	<u>10</u>
<u>Maintenance</u>	<u>10</u>
<u>General care and cleaning</u>	<u>10</u>
<u>Low pressure regulator (LPR) adjustment</u>	<u>10</u>
<u>Exhaust valve removal</u>	<u>27</u>
<u>Ram stroke adjustment</u>	<u>28</u>
<u>Ram snap ring adjustment</u>	<u>28</u>
<u>Testing pneumatics / electronics</u>	<u>29</u>

<u>Fault Finding Tables</u>	<u>30</u>
<u>Spare Parts</u>	<u>31</u>
<u>Useful Conversions</u>	<u>32</u>
<u>Warranties ECC / Rest of World excluding USA/Canada</u>	<u>33</u>
<u>Warranties USA / Canada</u>	<u>34</u>
<u>Update Information</u>	<u>36</u>
<u>Figures</u>	<u>12</u>
<u>Sectioned Angel LCD</u>	<u>11</u>
<u>ON / OFF functions</u>	<u>12</u>
<u>External menus</u>	<u>13</u>
<u>Tournament Internal menus</u>	<u>14</u>
<u>Pin number programming</u>	<u>15</u>
<u>Pin number Locking / Unlocking</u>	<u>16</u>
<u>Game timer functions</u>	<u>17</u>
<u>General assembly</u>	<u>18 19</u>
<u>Timer fast menu</u>	<u>20</u>
<u>Data Link</u>	<u>21</u>
<u>PCB Layout</u>	<u>22</u>
<u>Wiring connections: Intellifeed / Charger / Tab Key / 14 way valve / Battery & Data link)</u>	<u>23</u>
<u>Exhaust Valve Stem & Guide</u>	<u>24</u>
<u>LPR Assembly</u>	<u>24</u>
<u>Mini Regulator Assembly</u>	<u>25</u>
<u>Ram Assembly</u>	<u>25</u>
<u>Body Fixings</u>	<u>26</u>
<u>Trigger Assembly</u>	<u>26</u>

This Manual is Reproduced by kind permission of WDP Limited.
All Text & Copywrite WDP Limited 1999.

WARNINGS

IMPORTANT SAFETY GUIDELINES

WARNINGS FOR SAFE ANGEL LCD™ HANDLING

- The ANGEL LCD™ is not a toy.
- Careless or improper use, including failure to follow instructions in the operators Manual, could cause death or serious injury.
- Paintball industry standard head / face / throat / eye protection designed specifically for paintball games must be worn by user and any person within 200 yards (183 meters).
- Do not shoot at a person at close range.
- Observe all local laws, Regulations, and guidelines.
- Use only on professional paintball fields where codes of safety are strictly enforced.
- Must be at least 18 years of age to purchase and use under adult supervision
- Use compressed air / nitrogen only. DO NOT USE CO 2.
- Use 0.68 caliber paintballs only.
- Read Operators Manual before use and comply with all safety instructions.
- Insert barrel bung when not in use.
- Always switch gas source OFF when not in use.

● **⚠ WARNING** : THE ANGEL LCD™ CAN HOLD A SMALL CHARGE OF GAS, TYPICALLY 2 SHOTS. WITH THE GAS SOURCE REMOVED, FIRE THE ANGEL LCD™ TO REMOVE THIS SURPLUS GAS.

● Ensure the Tab key is inserted, or "SAFE" mode is selected when not in use.

● Never shoot at velocities in excess of 300FPS / 91.44 Meters per second.

● **⚠ WARNING** : Do not fire the ANGEL LCD™ with the breech open or without the bolt in the breech, as high pressure gas will be emitted. Never put high pressure gas directly against skin.

● **⚠ WARNING** : Do not fire the ANGEL LCD™ with the breech block pull knob in the unlocked position.

Never put your fingers or any foreign objects into the paintball feeding tube

● **⚠ WARNING** : SHOULD YOU BE UNSURE AT ANY STAGE YOU MUST SEEK EXPERT ADVISE

OPERATING INSTRUCTIONS

⚠ WARNING : THE CHARGER WILL BECOME WARM DURING USE DO NOT COVER THE CHARGER. ENSURE IT IS IN A VENTILATED LOCATION.

CHARGING

Before initial use of the ANGEL LCD™ it is necessary to give the power pack a full charging cycle of 7 hours prior to use as this will ensure the long life of the power pack. Subsequent charges will be in the region of 3-4 hours for full charge, The electronics will control the charging cycle and ensure that your battery does not take a nicad memory or exceed charging currents or temperatures.

- The ANGEL LCD™ may be left charging for prolonged periods without damage occurring to the battery pack.
- Full fast charge is a 3-4 hour charge cycle giving sufficient power for approximately 350,000 consecutive shots with the hopper also being powered.
- A 1-hour charge will give sufficient power for approximately 16,000 consecutive shots with the hopper also being powered.
- The ANGEL LCD™ will continue to use power even when in power saving sleep mode and a battery will discharge in approximately 288 hours even if the marker is not being used. To save your charge the insertion of the Tab Key will isolate the battery. We recommend its use for storage between events and when the ANGEL LCD™ is in transit.

Stage 1

Insert cigar lighter adapter into a 13.8V negative earth socket as found in most motor vehicles (red light on the adapter will illuminate to indicate that power is present).

Stage 2

Ensure the yellow Tab Key is removed from the rear panel of the ANGEL LCD™ No charging can occur until this Tab key is removed.

Stage 3

Insert remote plug from charger into the socket on the rear of the ANGEL LCD™ the socket is located on the rear of the grip frame under a rubber protection grommet.

CAUTION: Care must be shown with the charger to ensure the remote plug is not pulled or twisted by the lead. Shorting this lead can result in damage to the electronics in your ANGEL LCD™.

Stage 4

- The LCD on the ANGEL LCD™ will indicate the status of the charging cycle.
- The 4 bar segment will cascade to indicate charge is being taken.
- When a full charge has been taken all 4 segments will be illuminated permanently.
- The charge cycle cannot operate under the following conditions and a warning will be given on the LCD display, If the display shows "TAB IN" this is advising you of one or more of the following:
Tab Key is still inserted in the back panel or the battery is not plugged into the circuit board
- Removal of the charger before a full charge cycle has been completed will result in a short charge. The indicator will show all segments illuminated when the charger is removed but they will indicate the $\frac{3}{4}$, $\frac{1}{2}$, $\frac{1}{4}$, status more quickly due to the battery not being fully charged.
- If the charge cycle is interrupted before full charging has occurred the electronics will go into analysis mode and display all the segments cascading for up to 1 minute.

Stage 5

Unplug the charger from the ANGEL LCD™ and replace the rubber cover grommet to prevent the entry of dirt.

PROPELLANT AIR / NITROGEN SUPPLY

⚠ WARNING : ENSURE THE ANGEL LCD™ IS SWITCHED OFF BY INSERTING THE TAB KEY OR SWITCHING TO “SAFE” MODE PRIOR TO COMMENCING.

- Ensure the Angel LCD™ is in safe mode or the tab key is inserted.
- Ensure a barrel bung is fitted.
- Ensure eye protection is worn.
- Adhere strictly to all warnings given
- Ensure only air / nitrogen is used.
- Only use a regulator which has been designed for use with a paintball marker. Eg. the electronic Angel Air™

⚠ WARNING : SHOULD YOU BE UNSURE AT ANY STAGE YOU MUST SEEK EXPERT ADVICE

The ANGEL LCD™ is designed to operate on air or nitrogen only. This needs to be supplied to the ANGEL LCD™ at a regulated pressure of 800-850psi (55-59 BAR) from your first stage regulator. This can be achieved by the use of a suitable regulator such as the ANGEL AIR™. Connect the regulator gas outlet to the ANGEL LCD™ front grip using the connector supplied. Or a suitable 1/8 NPT connector can be used to make the connection. If using the Mamba Macro or Micro Line™ as supplied, the fittings may be removed by pulling back the collet to release the hose then shortening the hose to the length required before re-fitting.

SWITCHING THE ANGEL LCD™ ON

- To switch your ANGEL LCD™ ON ensure the battery is charged and the Tab Key is removed. Press and hold the RED button located on the rear of the grip frame for 1 second, The display will now read “SAFE”.
- Turn on your gas source.
- Press and hold the RED button for 1 second and the display will now show “LIVE”

⚠ WARNING : Adhere strictly to all safety warnings and guidelines The ANGEL LCD™ is now in an armed state.

FITTING THE HOPPER INTELIFEED™ (OPTIONAL ACCESSORY)

The ANGEL LCD has the ability to power motorized hoppers the agitation cycle and electrical supply coming from the ANGEL LCD™ direct. This Intellifeed system monitors your fire rate and switches on the agitator as necessary. (See diagrams General assembly & wiring diagram page 23)

- Remove the existing sight rail using suitable metric Allen key
- Remove the breech block pull knob by opening the breech, then unscrewing the pull knob while it is retracted.
- Remove the 2-countersunk Allen screws with suitable metric Allen key from the back plate, **Caution: A spring is located under the back plate.**
- Remove the left-hand side grip cheek and unplug the battery & 14-way solenoid.
- Remove the grip frame screws and remove the frame. **Caution: Care must be shown as the trigger return spring is located under the frame.**

FITTING THE HOPPER INTELIFEED™ (OPTIONAL EXTRA) CONTINUED

- Insert the replacement sight rail and wiring loom, Feeding the wires and white plug through the body to exit at the underside by the other plugs.
- Refit the frame. **Caution: Care must be shown to ensure the spring is located correctly.**
- Insert all plugs in their relevant sockets, see diagram page 22 **Caution: Care must be shown to ensure wires do not snag on the "vibes" vibrator motor.**
- Refit grip cheek cover, rear back plate, breech block pull knob & the sight rail.
- The flying lead has a mating plug that fits to the socket on the sight rail, This should be soldered directly to the hopper motor. All other electronics within the hopper must be removed prior to fitting this lead. Each lead may be soldered to either of the motor connections, see diagram page 23

NOTES

- When in semi mode, single shots at a rate of less than one shot per second causes the hopper not to agitate. Shots greater than two shots per second the agitator to agitate for two seconds. This cycle will repeat as the trigger is pulled.
- When in enhanced modes the hopper will agitate on first shot.

BOLT REMOVAL ROTOR BREECH™

⚠ WARNING : Do not fire the ANGEL LCD™ with the breech open or without the bolt in the breech.

- Ensure the ANGEL LCD™ is in "SAFE" mode or the Tab key is inserted.
- Pull the 'Pull knob' and rotate 90 degrees so that the knob remains in the unlocked position.
- Swing out the Rotor Breech block so that the bolt is exposed. The breech will not open if the bolt is in the forward position. Ensure it is retracted by either: momentarily gassing the ANGEL LCD™ or pushing the bolt back with a squeegee
- Retract the bolt by pulling rearwards.
- Replace the bolt. Follow stages in reverse order.

VELOCITY ADJUSTMENT

⚠ WARNING : Velocity adjustments need to be carried out using a suitable chronograph. The current maximum velocity allowed in tournament play is 300 FPS. Max velocity is governed by local applicable law. Check with law enforcement office, or local professional paintball venue for limits in your area.

The velocity adjusting screw is located on the lower portion of the front grip. Use a suitable metric 3mm A/F Allen key to adjust.

Decrease velocity

- To decrease the velocity, insert 3 mm A/F Allen key and rotate CLOCKWISE. **Caution: When reducing velocity, allow four shots for the complete system to be at the new regulated pressure.**

Increase velocity

- To increase the velocity insert 3.0 mm A/F Allen key and rotate COUNTERCLOCKWISE.

EXTERNAL ELECTRONIC LCD MENUS

The ANGEL LCD™ has a number of features that can be adjusted to suit your individual needs. These features are designed to enhance your play and also to supply you with a wealth of information. These are accessible via the external menu list. You can also read the setting that has been set via the internal menu list. (See external menu diagrams page 14)

- The menus can only be accessed when the marker is in "SAFE" mode and the Tab Key is removed.
- Follow the external menu list diagrams for relevant settings.
- Should you wish to return to factory settings the ANGEL LCD™ has a unique feature that allows you to return to the factory defaults. See internal menu diagram for instructions page 14. The ANGEL LCD™ also has the unique feature that ensures any settings that you enter are stored in a non-volatile memory that will not be lost by the removal of the battery or a flat battery status.

Back- light feature

This enables you to switch ON or OFF the back- lighting on your display. (See external menu diagrams for setting page 13).

Temperature feature

This allows you to set the temperature display between Fahrenheit and Centigrade. This feature is useful in determining the ambient temperature to allow you to select your accessories for the climatic conditions in the format you prefer. This can not be changed by the external menu (See Internal menu diagrams for setting page 14). NOTE: This can not be changed externally.

Cycles (total shot) feature

This is a chronological record of the total number of shots fired by your ANGEL LCD™. The user cannot reset this. (See external menu diagrams for setting page 13).

Trip (shot counter) feature

This allows you to record the number of shots fired at any stage e.g.: Per game, per event or per day. It may be reset at any time you require. (See external menu diagrams for setting page 13).

Faults feature

This is a self-diagnostic fault finding program that will check the condition of the electronic circuits.

TAB IN = Battery disconnected or Tab Key inserted when trying to charge

CODE 1 = Faulty battery

CODE 2 = Hopper using too much power (sticky motor)

CODE 3 = Over temperature (ambient temperature too high)

CODE 4 = Under temperature (ambient temperature too low)

(See external menu diagrams).

ID Number feature

Unique ID numbers that must be quoted for all repair work.
(See external menu diagrams page 13).

ROF feature (rate of fire)

This records your highest rate of fire you actually achieved over a 1-second period. The data will be constantly updated should the new reading exceed the previous reading. You can zero the ROF feature at any time. (See external menu diagrams for setting page 13).

EXTERNAL ELECTRONIC LCD MENUS CONTINUED

MROF feature (maximum rate of fire limit)

This allows you to tune your maximum rate of fire to your style of play and feed system. Certain modes are capped and non-adjustable. The rate of fire should not be set greater than what your feed system is capable of delivering. This can not be changed by the external menu (See Internal menu diagrams for setting page 14). See table on Modes for maximum allowable settings page 9. NOTE: This can not be changed externally.

Timer feature (game timer)

The "vibes" timer is a new and unique interactive game timer that takes the stress out of game play. It will also allow you to play set moves in unison with your colleagues. The timer can be set in 1 minute increments from 5 to 20 minutes then in 5 minute increments from 25 - 60 minutes. The timer is started via your first shot, which allows you to concentrate on your game play. The alarms will activate reset every 5 minutes, the last minute and the last 10 seconds of the set time. (See setting and using game timer diagrams page 17).

Dwell feature

Dwell is what controls the valve opening time. Longer dwell uses more gas and generates more noise but allows the marker a greater tolerance to paint, temperature and pressure variables. Shorter dwell uses less gas and reduces noise but will not tolerate poor quality paint.

Caution: Adjustment is only recommended if you wish to fine-tune your marker to specific accessories. (See Internal menu diagrams for setting page 14). NOTE: This can not be changed externally.

Vibes game alarm feature

This feature allows you to switch the vibrator alarm On or Off. The vibes alarm is independent of the game timer functions. (See external menu diagrams for setting page 14).

Mode feature

26 modes of shooting may be selected. The firing modes listed are programmed in the ANGEL LCD™. Including 5 modes that you may program yourself using the ANGEL DATA LINK. (See Internal Tournament LCD adjustments and diagrams for setting page 13). NOTE: This can not be changed externally.

⚠ WARNING : In certain countries local applicable laws may mean certain modes may not be enabled or allowed. Check with law enforcement office, or local professional paintball venue.

Battery Status feature

The battery status is indicated at all times by the 4-segment display. Power is drawn whilst the ANGEL LCD™ has power connected. A battery will last approximately 280 hours until it is discharged. To prevent this discharge ensure the Tab Key is inserted at the end of the day or event. The last segment indicates that you have approximately 16000 shots left with a hopper being powered.

Pin number feature

If you have entered a Pin number this feature allows you to enter the pin number to lock or unlock your ANGEL LCD™. The Pin Feature will help to prevent unauthorized use. **Caution: Once the pin number is set should you forget your pin code, and cannot unlock the ANGEL LCD™ you must contact WDP Ltd and have to hand your unique serial number. This can be displayed by pulling the trigger when the ANGEL LCD™ is locked or in safe mode. You must also provide verifiable proof of purchase and identity before we will issue you a unique unlocking code to your ANGEL LCD™. When entered this code allows you to enter a fresh pin number. You may incur a small administration charge for this service.** (See Pin number menu diagram for setting page 15).

INTERNAL TOURNAMENT LCD

- The ANGEL LCD™ has a number of features that can be adjusted to suit your individual needs. These features that can change the performance of the gun are only accessible via the internal menu list. This is to ensure that they pass tournament and field operator requirements.
- The menus can **only** be accessed when the marker is in “safe” mode and the Tab Key is removed.
Remove left hand grip cover screws to expose the circuit board.
- Follow the internal menu list diagrams for relevant settings.
Should you wish to return to factory settings the ANGEL LCD™ has the unique feature that allows you to return to the factory defaults. (See internal menu diagram for instructions. page 14)
- The ANGEL LCD™ also has the unique feature that ensures any settings that you enter are stored in a non-volatile memory that will not be lost by the removal of the battery or a flat battery status.

Mode feature

26 modes of shooting may be selected. The firing modes listed below are programmed in the ANGEL LCD™. Including 5 modes that you may program yourself using the ANGEL DATA LINK. (See Internal Tournament diagrams for setting page 14).

⚠ WARNING : In certain countries local applicable laws may mean certain modes may not be enabled or allowed. Check with law enforcement office, or local professional paintball venue.

- A = Auto to a Max of 13/sec
- B = TRUE SEMI Max of 20/sec
- C = 2 shot burst variable rate to a Max of 13/sec
- D = 3 shot burst variable rate to a Max of 13/sec
- E = 4 shot burst variable rate to a Max of 13/sec
- F = 5 shot burst variable rate to a Max of 13/sec
- G = 6 shot burst variable rate to a Max of 13/sec
- H = 7 shot burst variable rate to a Max of 13/sec
- I = 8 shot burst variable rate to a Max of 13/sec
- J = 2 shot ZIP fixed rate of 8.75/sec
- K = 3 shot ZIP fixed rate of 8.75/sec
- L = 4 shot ZIP fixed rate of 8.75/sec
- M = 5 shot ZIP fixed rate of 8.75/sec
- N = 6 shot ZIP fixed rate of 8.75/sec
- O = 7 shot ZIP fixed rate of 8.75/sec
- P = 8 shot ZIP fixed rate of 8.75/sec
- Q = 10 ms reduction between shots ramp Max rate of 13/sec
- R = 20 ms reduction between shots ramp Max rate of 13/sec
- S = 40 ms reduction between shots ramp Max rate of 13/sec
- T = Programmable mode via data link Max rate of 13/sec
- U = Programmable mode via data link Max rate of 13/sec
- V = Programmable mode via data link Max rate of 13/sec
- W = Programmable mode via data link Max rate of 13/sec
- X = Programmable mode via data link Max rate of 13/sec
- Y = Multiplier (locked out sleeper)
- Z = TT (locked out sleeper)

Dwell feature

Dwell is what controls the valve opening time. Longer dwell uses more gas and generates more noise but allows the marker a greater tolerance to paint, temperature and pressure variables. Shorter dwell uses less gas and reduces noise but will not tolerate poor paint on pressure variables. Adjustment is only recommended if you wish to fine-tune your marker to specific accessories. Optimum setting is 14 milliseconds
Adjustment range 10 milliseconds to 24 milliseconds. **Caution To lower dwell setting may cause low velocity, always verify that your velocity has not been affected.**
(See Internal menu diagrams for setting), see diagram page 14.

INTERNAL TOURNAMENT LCD CONTIUED

MROF maximum rate of fire limit

This allows you to tune your maximum rate of fire to your style of play and feed system. Certain modes are capped or non-adjustable. The rate of fire should not be set greater than what your feed system is capable of delivering. See table on Modes for maximum allowable settings.
(See Internal menu diagrams for setting page 14).

Temperature feature

This allows you to set the temperature display between Fahrenheit and centigrade. This feature is useful in determining the ambient temperature to allow you to select your accessories for the climatic conditions in the format you prefer. (See Internal menu diagrams for setting page 14).

Pin number setting feature

This allows you to set your own personnel pin number for added security. When the pin number is enabled the ANGEL LCD™ is locked and incapable of firing to prevent unauthorized use. We recommend you use this security feature to protect your investment and others from misuse. **Caution: Once the pin number is set should you forget your pin code, and cannot unlock the ANGEL LCD™. You must contact WDP Ltd, and have to hand your unique serial number, which can be displayed by pulling the trigger when the ANGEL LCD™ is locked or if safe mode. You must also provide verifiable proof of purchase and identity before we will issue you a unique unlocking code to your ANGEL LCD™. When entered this code allows you to enter a fresh pin number. You may incur a small administration charge for this service.** (See Pin number menu diagram for setting page 15.)

NOTE: All the features that are available on the external menu can also be accessed from the internal menu for your convenience. (See external menu list for these other settings page 13).

MAINTENANCE

GENERAL CARE AND CLEANING

The ANGEL LCD™ should be cleaned externally using a synthetic oil moistened cloth only. Under no circumstances should you use hydrocarbon-based oils, as these will cause irrevocable damage to the internal seals, e.g.: WD40, Vaseline, Duck oil, Engine oil, Plus gas or 3 in 1. Suitable oils are Gold cup & Automag lubricant. **Caution: No solvents, chemical or abrasive cleaning products should be used.** All external and internal moving parts should be lubricated using light synthetic oil only. The frequency should be at least every event or 8000 shots, this can be achieved by adding 2 drops of oil into the exhaust port located under the rotar breech.

The ANGEL LCD™ should never be immersed into water otherwise damage may occur to the electronics. The electronics are moisture / damp proof only to IP65. Ensure correct tools are used only. All threads are metric except gun accessory mountings onto the grip frame, which is industry standard 10/32 UNF at centers 0.75 inches. The screw thread length must not exceed 0.375 inches 10mm into the bottom of the frame otherwise damage will occur to the electronics. We recommend that you remove the left-hand cheek cover and ensure the screws do not project into the circuit board cavity when attaching accessories.

LOW PRESSURE REGULATOR (LPR) ADJUSTMENT

The low-pressure regulator controls the pneumatic cycle of the ANGEL LCD™ and is located in the left-hand chamber in the front of the ANGEL LCD™ body. The pressure needs to be at 85 PSI (6.0 BAR) and adjustment is achieved by the addition of or removal of shims. Each shim equals approximately 3.5 PSI / 0.2BAR. We recommend the use of the optional service tools and lubricate parts with synthetic lubricant only (See general assembly diagram page 18 - 19 and page 24).

The Most Advanced Paintball Marker In The World

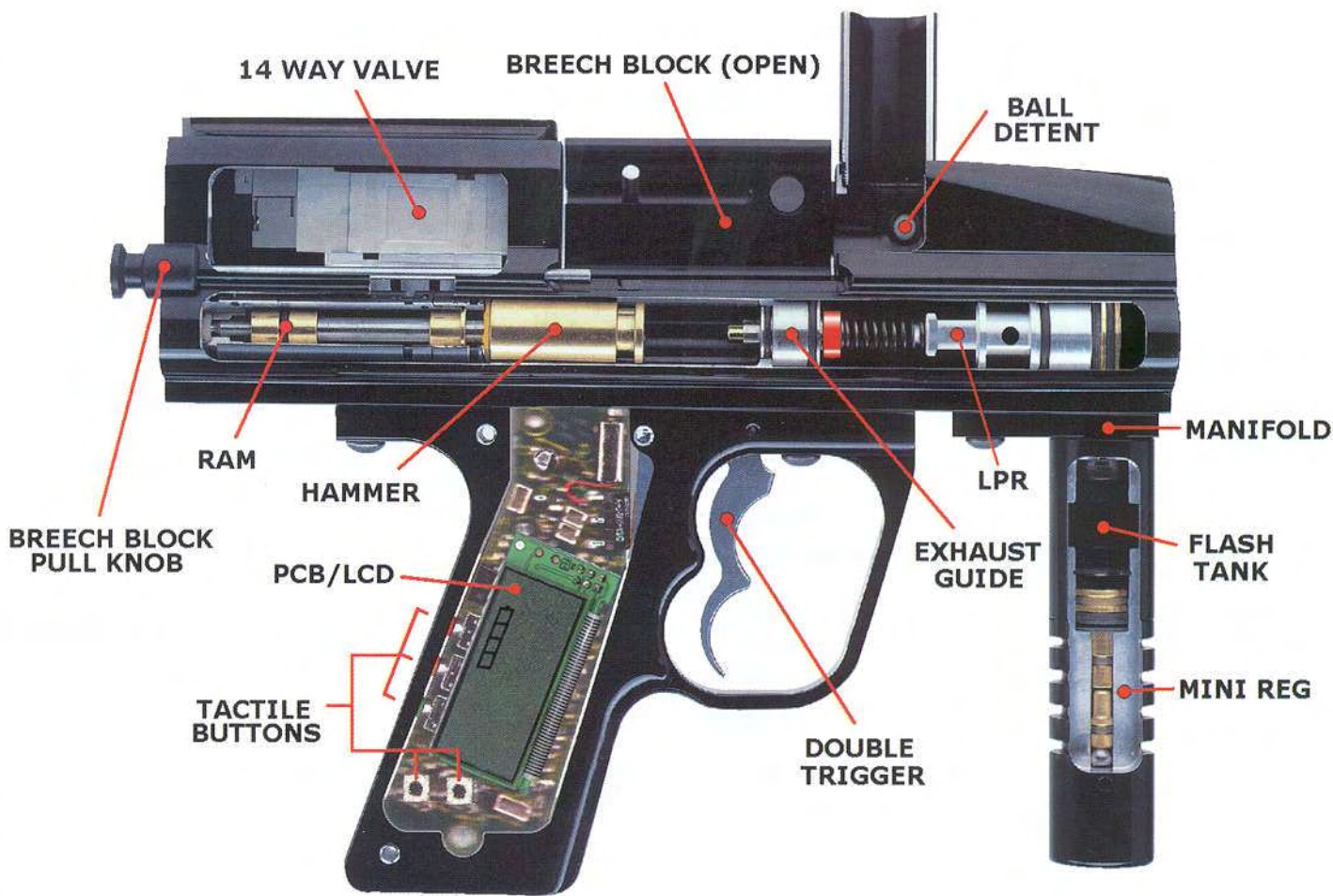

© NPF Ltd 1999
PATENTS APPLIED FOR
JRR ISSUE2



ON / OFF FUNCTIONS

ON / OFF TRANSIT MODE

ON / OFF POWER SAVING MODE

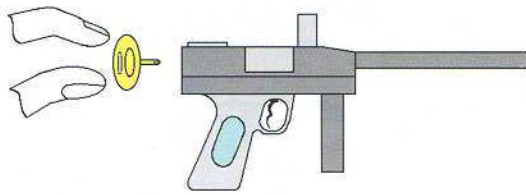

TO SWITCH POWER ON, ENSURE TAB KEY IS REMOVED FROM BACK PANEL. INSERTION OF THE KEY WILL ISOLATE THE BATTERY RESULTING IN COMPLETE SHUT DOWN OF THE ELECTRONICS IDEAL FOR TRANSIT OF THE MARKER.

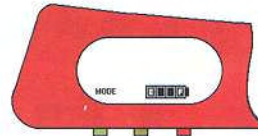

PRESS AND HOLD BUTTON FOR 2 SECS. POWER SAVING WILL ONLY OCCUR IF THE MARKER IS IN SAFE MODE AFTER 2 HOURS OF INACTIVITY

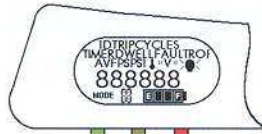

AUTOMATIC TEST DISPLAYED FOR 1 SEC



MARKER UNABLE TO FIRE
RED, AMBER & GREEN
BUTTONS OPERATIVE

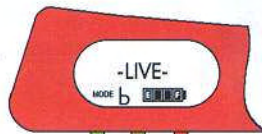

WARNING
THE MARKER IS LIVE
CAPABLE OF DISCHARGING
OBSERVE SAFETY GUIDELINES



TO MAKE MARKER LIVE
PRESS AND HOLD THE
BUTTONS FOR 2 SECONDS



TO MAKE MARKER SAFE
PRESS AND HOLD THE
BUTTONS FOR 2 SEC.
POWER SAVING WILL
ONLY OCCUR IF THE
MARKER IS IN SAFE
MODE AFTER 2 HOURS
OF INACTIVITY.

EXTERNAL MENU LIST

NOTE ACCESS IS NOT GRANTED IF:- POWER IS NOT ON, OR KEY INSERTED IN REAR PANEL MARKER IN LIVE READY TO FIRE STATE

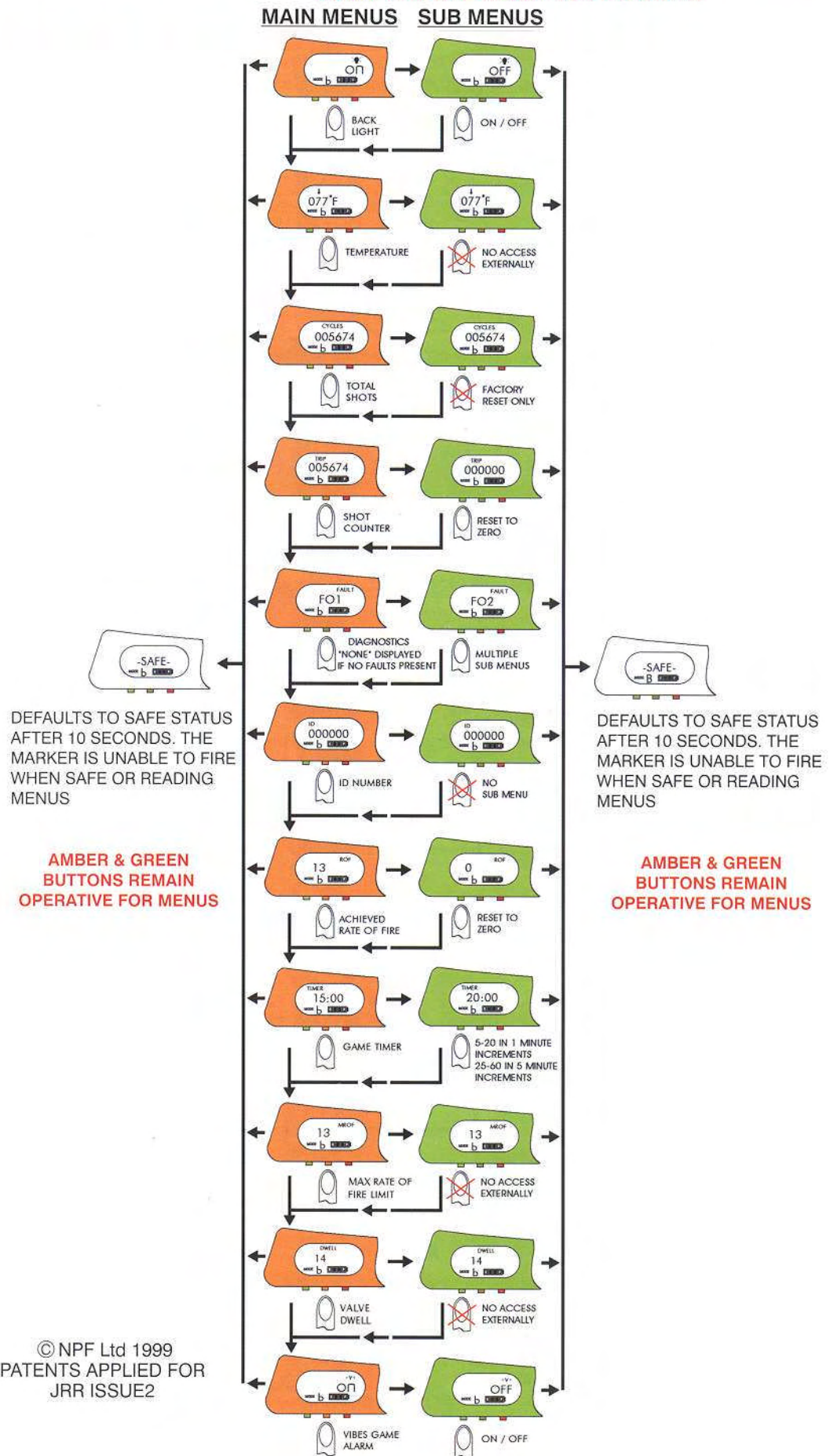

TOURNAMENT INTERNAL MENU LIST

NOTE ACCESS IS NOT GRANTED IF:- POWER IS NOT ON, OR KEY INSERTED IN REAR PANEL MARKER IN LIVE READY TO FIRE STATE

MAIN MENUS SUB MENUS

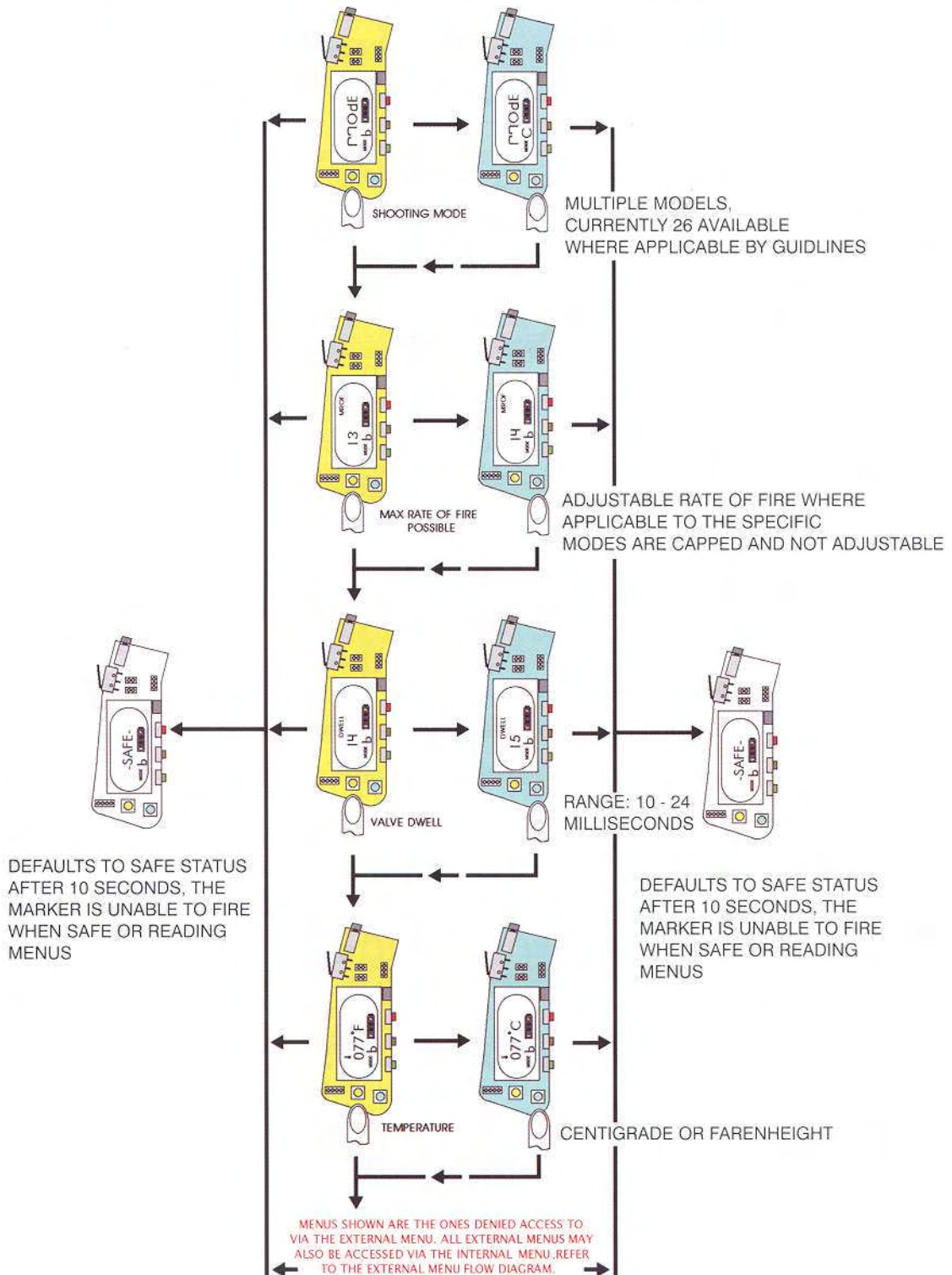

RESETS



RESET DEFAULTS

VIBES	ON	ID NUMBER	NOT APPLICABLE
BACKLITE	OFF	ROF	0
TEMPERATURE	FARENHEIGHT	TIMER	15 (MINUTES)
CYCLES	NOT APPLICABLE	MODE	B (TRUE SEMI)
TRIP	000000	MROF	11 (SHOTS/SEC)
FAULT	NONE	DWELL	14 (MILLISECS)

© NPF Ltd 1999
PATENTS APPLIED FOR
JRR ISSUE2

PIN NUMBER PROGRAMMING

- THE PIN NUMBER MAY ONLY BE PROGRAMMED ONCE
- RESETTING PIN NUMBERS CAN ONLY BE DONE BY CONTACTING WDP Ltd.
- NOTES: ● PROGRAMMING CAN ONLY BE DONE WITH THE MARKER SAFE
- FACTORY DEFAULTS WILL NOT OVERRIDE THE PIN NUMBER PROGRAMMING
- THE MARKER BECOMES PIN NUMBER SECURE ONLY BY THE USER ENTERING THE PIN TO LOCK THE MARKER

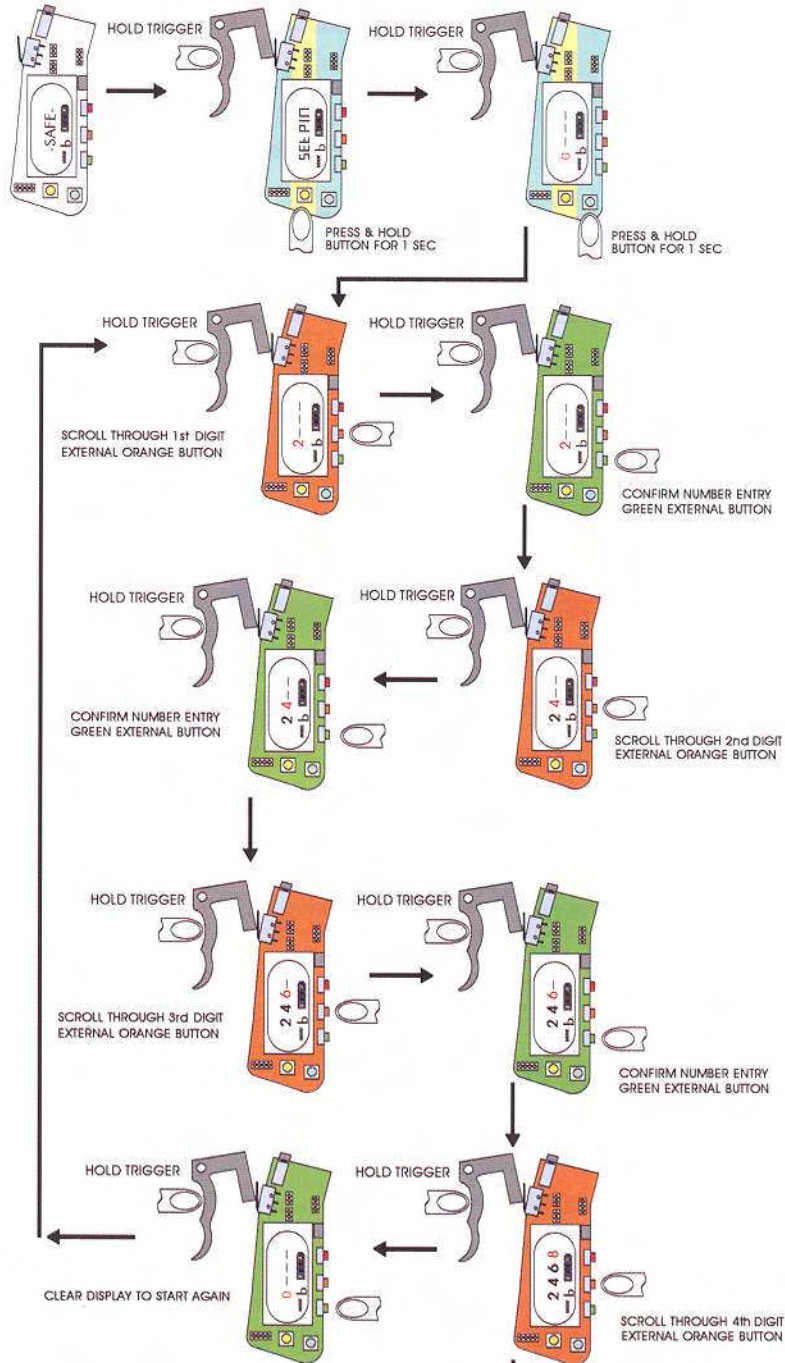

WARNING PIN NUMBER CANNOT BE CHANGED ONCE CONFIRMED

CORNFIRM
FULL PIN NUMBER ENTRY
RED EXTERNAL BUTTON
PIN NUMBER NOW PROGRAMMED
YOUR PIN NUMBER

--	--	--	--

EXAMPLE USES 2468, YOU MAY PROGRAM YOUR OWN PIN NUMBER.
IF YOU WISH TO TRY THIS FEATURE WITHOUT IT BEEN STORED IN THE
NON VOLITILE MEMORY USE PIN NUMBER 0000

© NPF Ltd 1999
PATENTS APPLIED FOR
JRR ISSUE2

PIN NUMBER LOCKING / UNLOCKING

- NOTES:**
- PIN LOCK & UNLOCK CAN ONLY BE DONE WITH THE MARKER SAFE
 - FACTORY DEFAULTS WILL NOT OVERRIDE THE PIN NUMBER LOCK
 - THE MARKER BECOMES PIN NUMBER SECURE ONLY BY THE USER ENTERING THE PIN TO LOCK THE MARKER

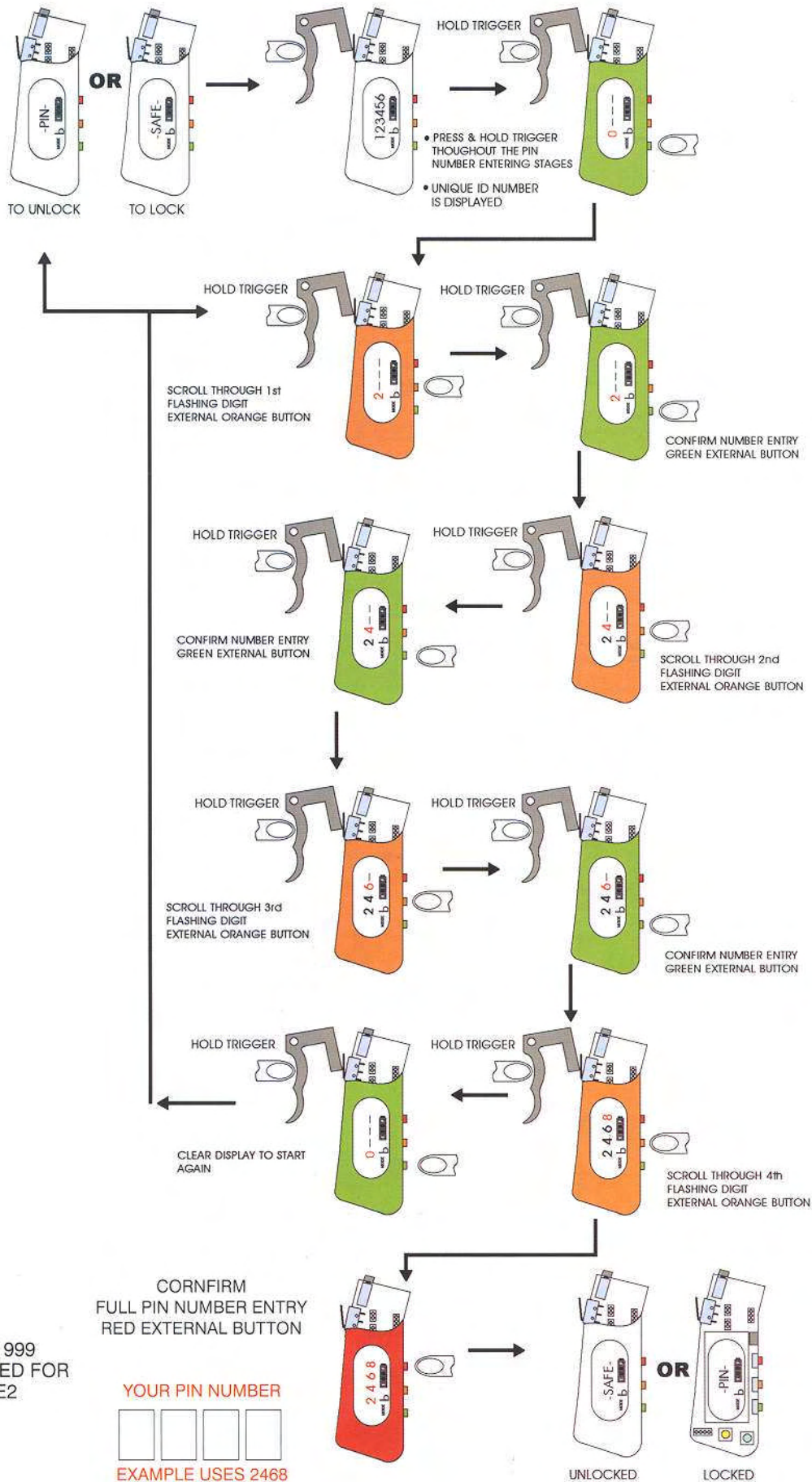

© NPF Ltd 1999
 PATENTS APPLIED FOR
 JRR ISSUE2

GAME TIMER FUNCTIONS

TO SWITCH POWER ON, ENSURE KEY IS REMOVED FROM BACK PANEL. PRESS AND HOLD BUTTON FOR 2 SECS. POWER SAVING WILL ONLY OCCUR IF THE MARKER IS IN SAFE MODE AFTER 2 HOURS ON INACTIVITY.

WAKE UP MODE

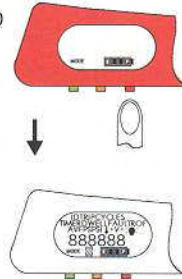

AUTOMATIC TEST DISPLAYED FOR 1 SEC

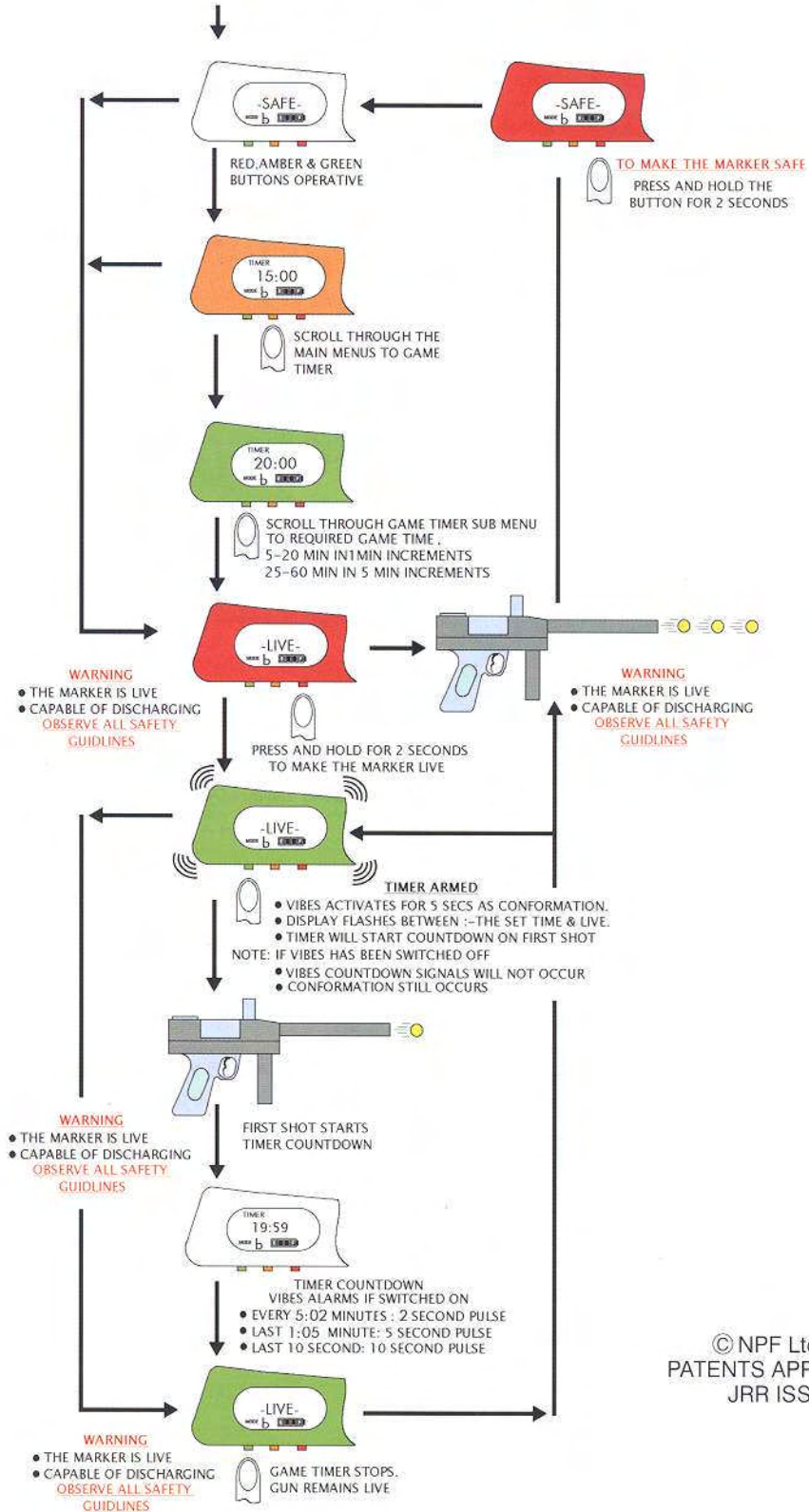

GENERAL

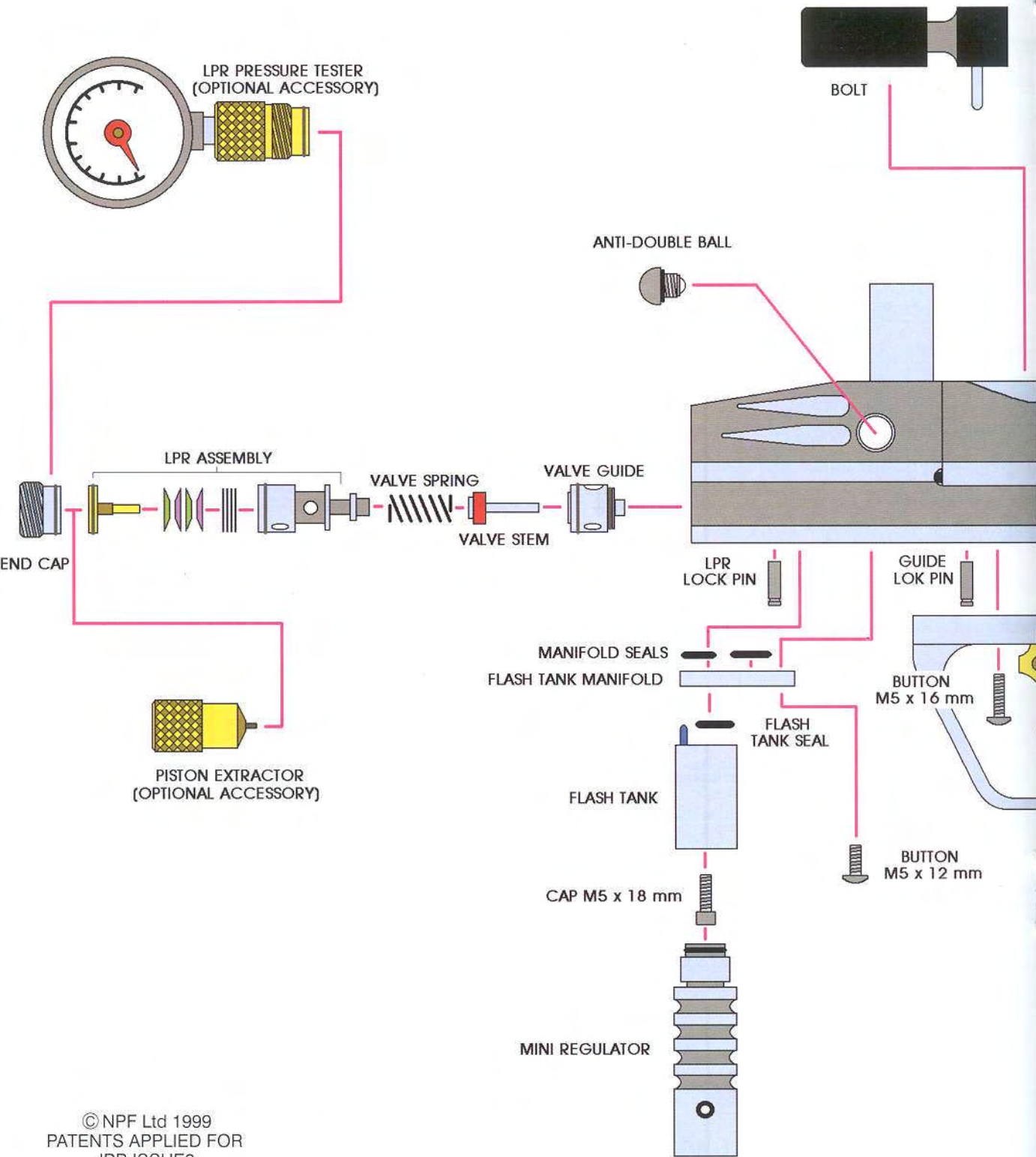

ASSEMBLY

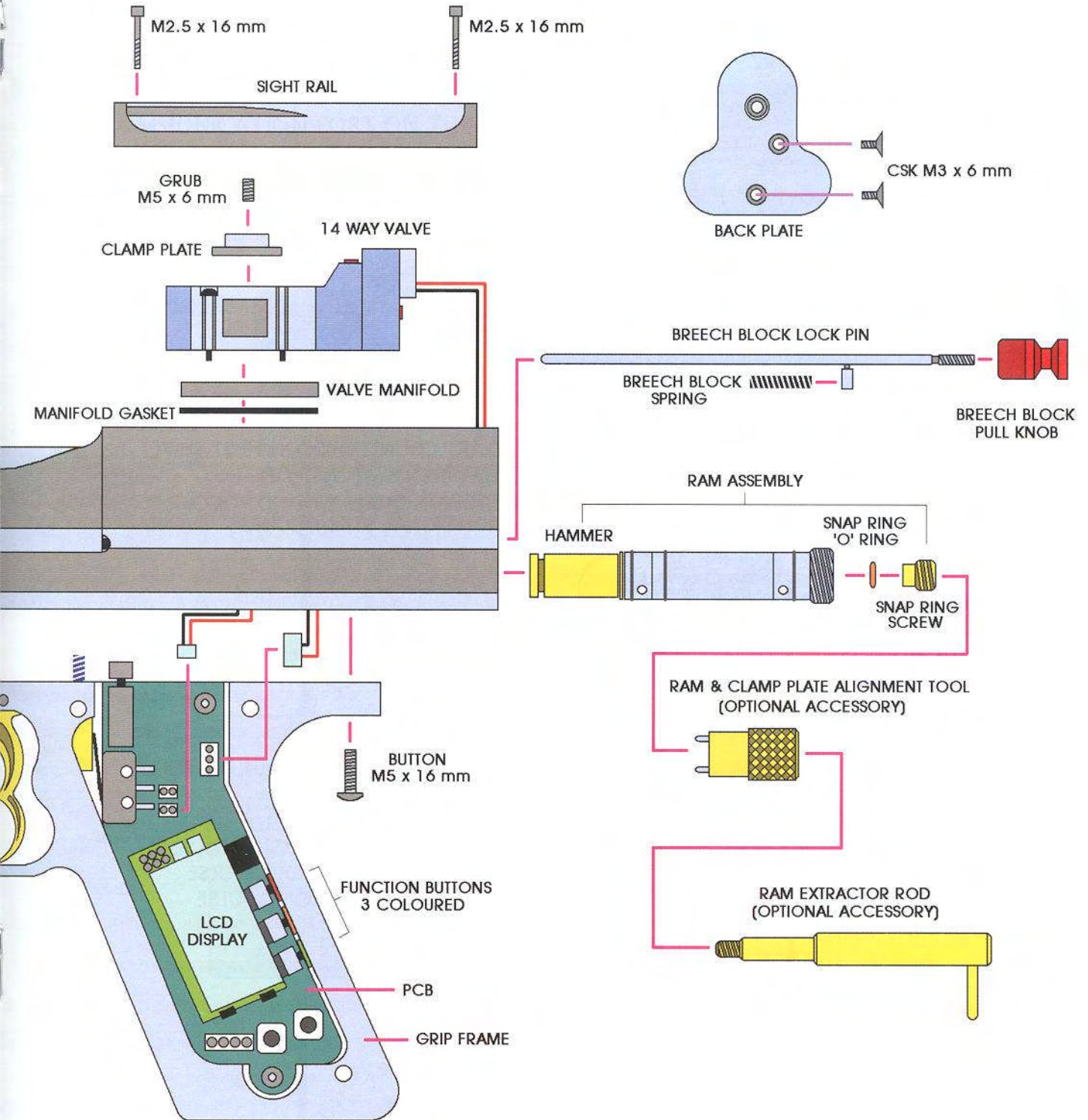

TIMER FAST MENU

THIS SHOWS THE EASY STEPS TO USE YOUR GAME TIMER ONCE THE START TIME HAS BEEN SET. THE TIMER WILL REMEMBER THE SET TIME EVEN WHEN THE MARKER HAS A FLAT BATTERY. SET THE TIMER TO REQUIRED TIME AT THE BEGINING OF THE DAY IF IT IS DIFFERENT TO THE LAST OCCASION YOU USED IT. REMEMBER IF YOU REQUIRE VIBES ALARMS ENSURE THEY ARE SWITCHED ON. THEN JUST FOLLOW THE STEP LISTED BELOW.

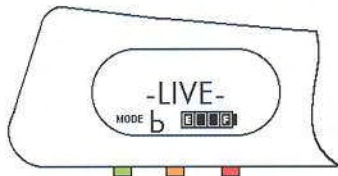

WARNING

- THE MARKER IS LIVE
 - CAPABLE OF DISCHARGING
- OBSERVE ALL SAFETY GUIDELINES**

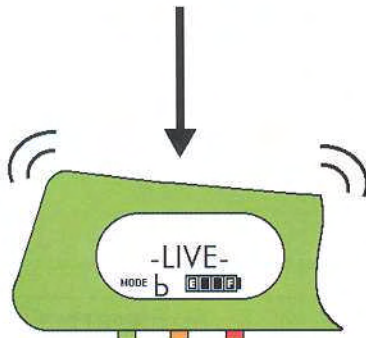

TIMER ARMED

- VIBES ACTIVATES FOR 5 SECS AS CONFIRMATION.
 - DISPLAY FLASHES BETWEEN :-THE SET TIME & LIVE.
 - TIMER WILL START COUNTDOWN ON FIRST SHOT
- NOTE: IF VIBES HAS BEEN SWITCHED OFF
- VIBES COUNTDOWN SIGNALS WILL NOT OCCUR
 - CONFIRMATION SIGNAL STILL OCCURS

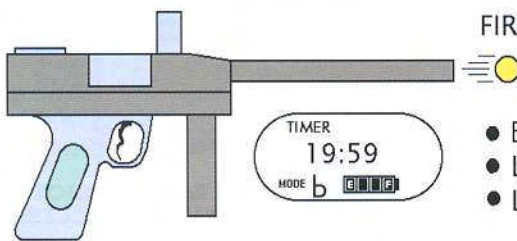
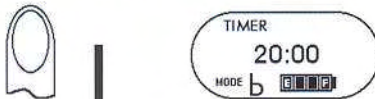

FIRST SHOT STARTS TIMER COUNTDOWN

- VIBES ALARMS IF SWITCHED ON**
- EVERY 5:02 MINS: 2 SECOND PULSE
 - LAST 1:05 MINS: 5 SECOND PULSE
 - LAST 10 SECS: 10 SECOND PULSE

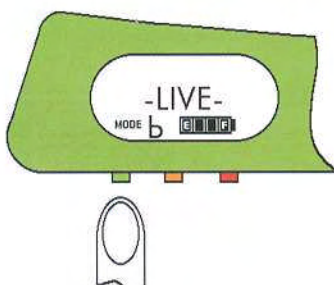

**GAME TIMER STOPS.
GUN REMAINS LIVE**

ANGEL DATA LINK TO PC/APPLEMAC (OPTIONAL ACCESSORY)

CONNECT 9 PIN D PLUG INTO COMMUNICATION PORT ON THE COMPUTER

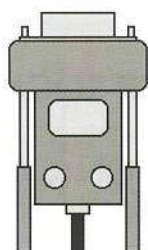
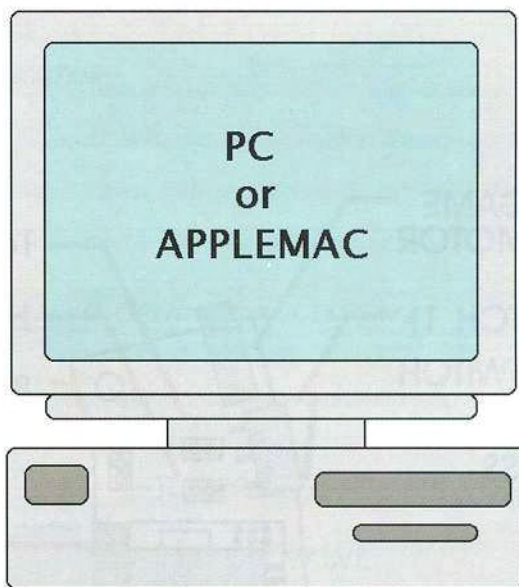

COMM PORT
9 PIN D PLUG

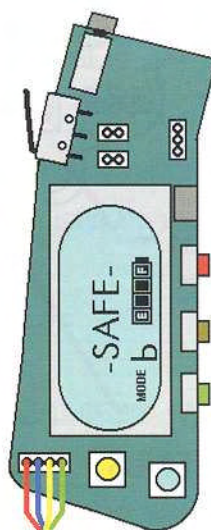

ANGEL PCB ACCESS
GAINED BY REMOVING
LEFT HAND GRIP CHEEK
COVER

4 PIN DATA LINK
PORT

MARKER MUST BE IN SAFE
MODE FOR COMMUNICATION
BETWEEN COMPUTER AND
MARKER

PCB LAYOUT & CONNECTIONS

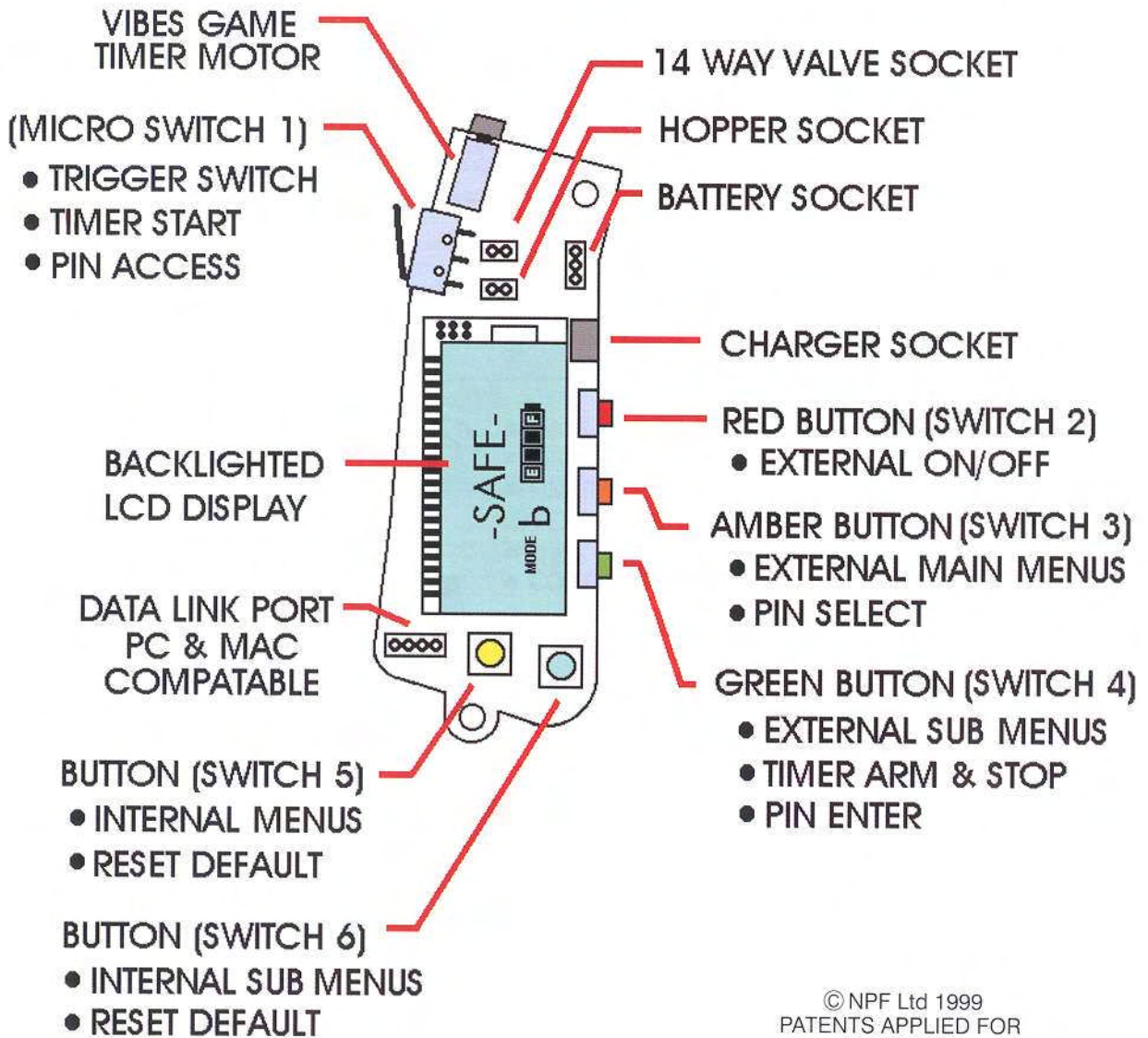

© NPF Ltd 1999
PATENTS APPLIED FOR
JRR ISSUE2

WIRING CONNECTIONS

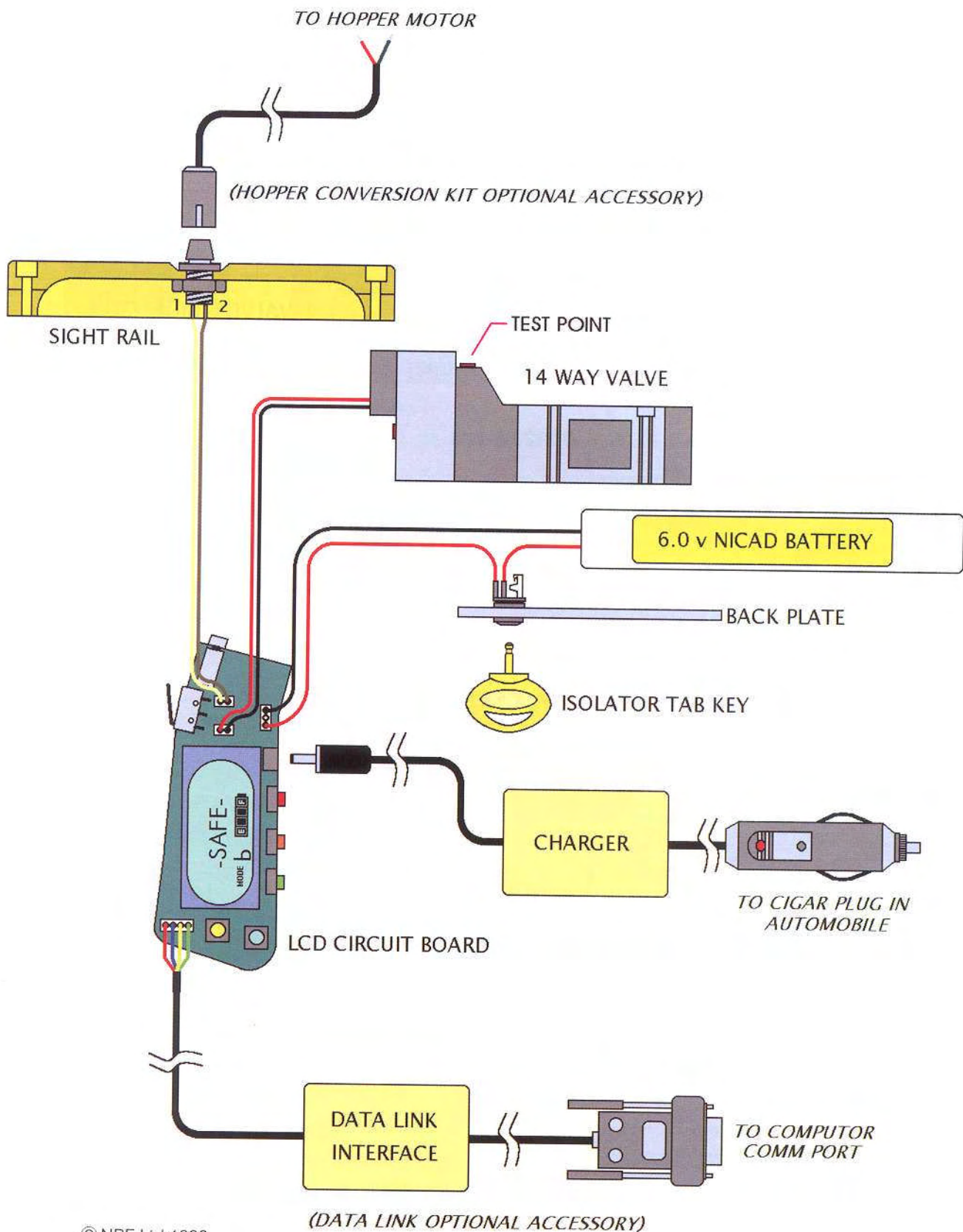

EXHAUST VALVE STEM & GUIDE

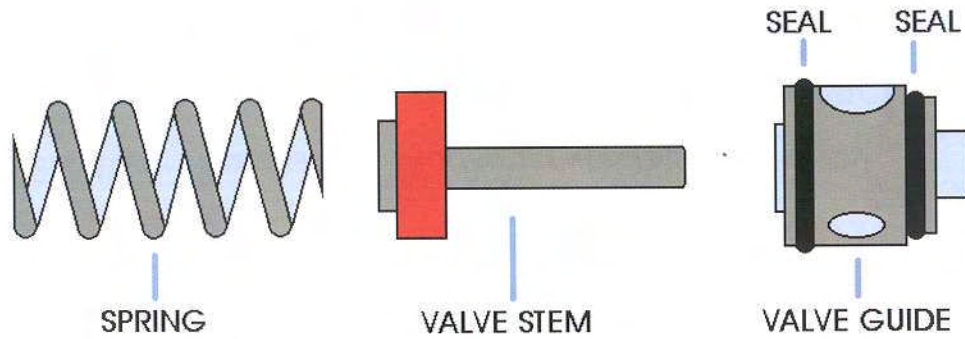

LPR ASSEMBLY

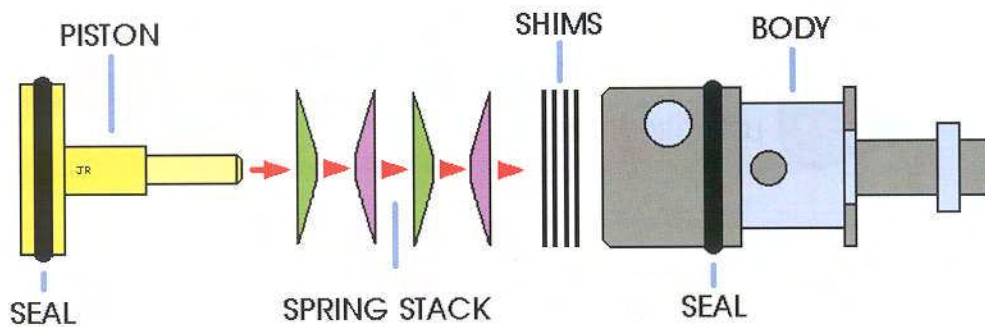

MINI REGULATOR

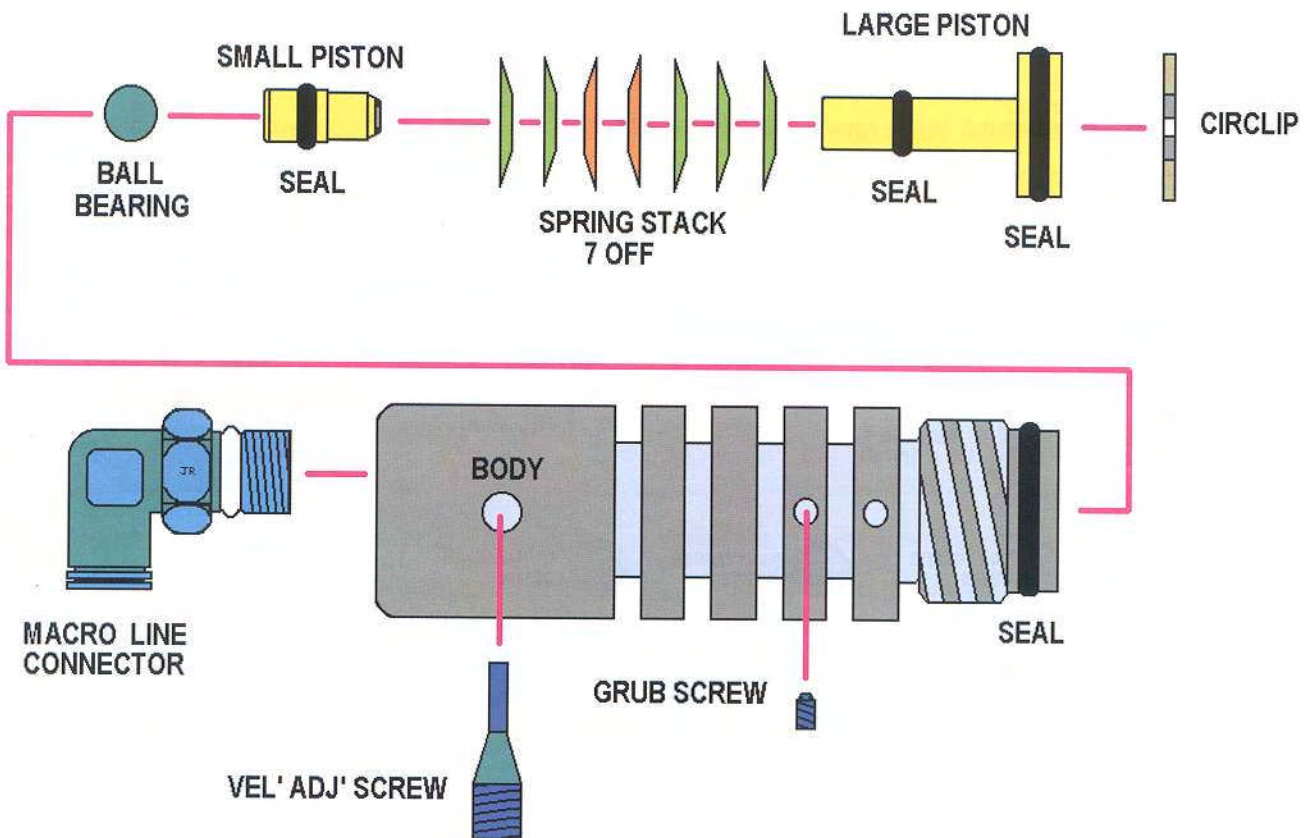

RAM ASSEMBLY

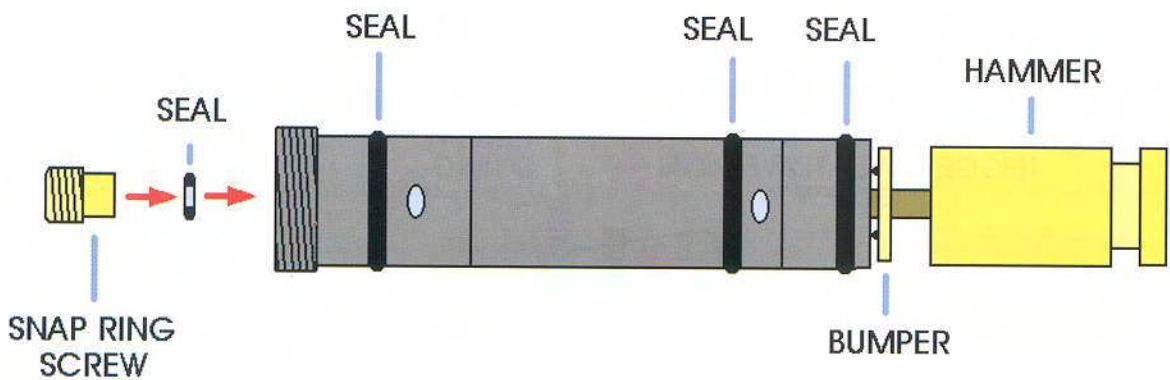

BODY FIXINGS

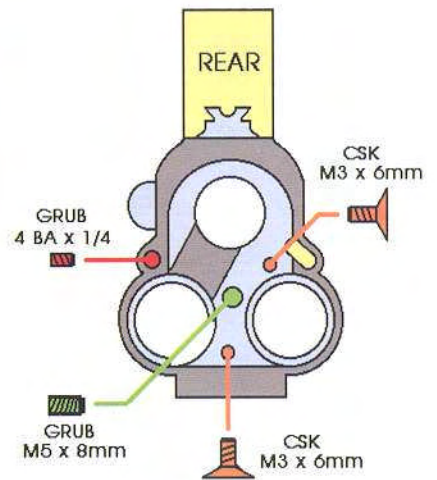
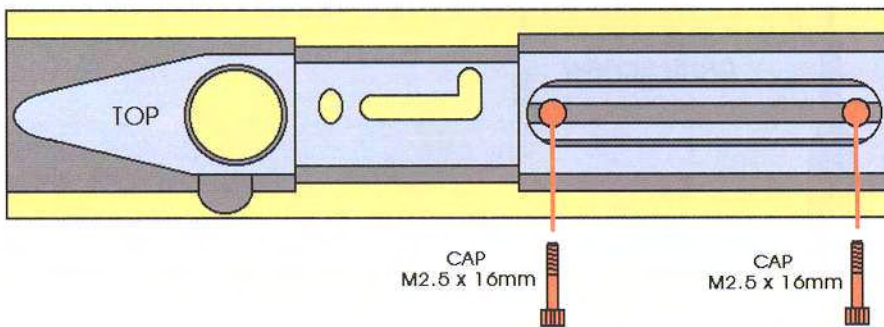
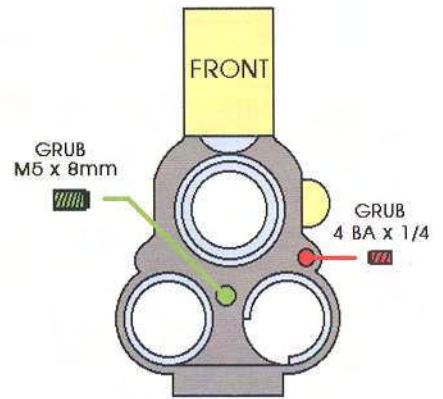
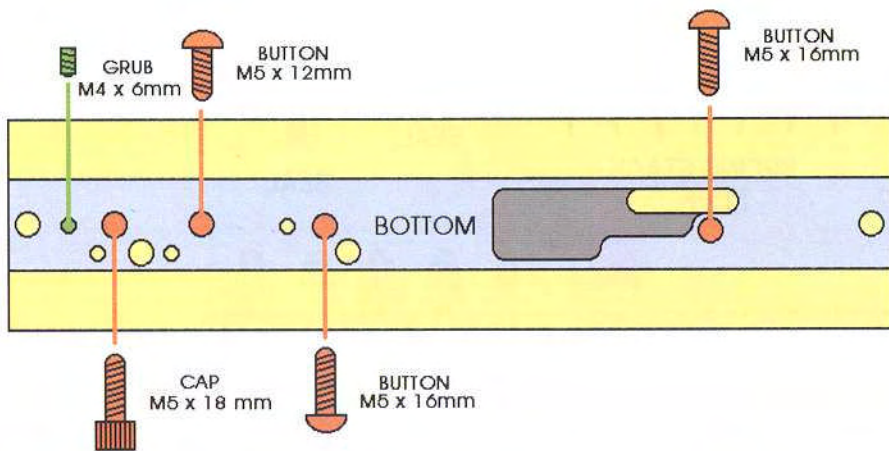

TRIGGER ASSEMBLY

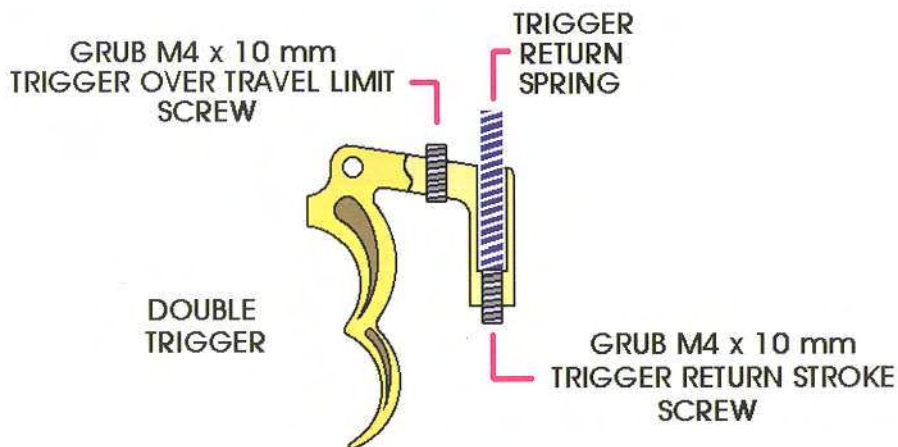

EXHAUST VALVE REMOVAL

- Ensure the ANGEL LCD™ is degassed and in "SAFE" mode or the tab key inserted.
- Remove the left end cap using suitable metric 4.0 mm A/F Allen key. Unscrew the mini reg.
- Remove the flash tank by inserting a 4mm A/F Allen key into the cap head screw located in the flash tank. Caution there is 1 'O' ring located on the top of the flash tank.
- Remove the flash tank manifold by inserting a 3mm A/F Allen key into the button head screw located on the manifold. Caution there are 2 'O' rings located on this manifold.
- Pull out the LPR retaining pin.
- Remove the LPR piston. Use the LPR piston extraction tool (optional accessory). Ensure the springs and shims are also removed
- Using a suitable blunt hooked pick slowly retract LPR by inserting the pick into the LPR piston hole. **Caution: care must be taken so that the bore is not scored or the seals are damaged.**
- Remove the valve spring and exhaust valve stem. See diagrams pages 18 - 19 and 24

IMPORTANT NOTES: for re-assembly of components.

- Ensure exhaust valve is located in exhaust body within the ANGEL LCD™.
- Ensure the spring is located onto the LPR body.
- Ensure the hole in the LPR body is in the correct orientation to the LPR lock pin hole in the main body prior to refitting.
- Slowly insert the LPR pushing it down with your thumb, when the holes line up insert the lock pin into the hole.
- Ensure the shims have been replaced.
- Ensure the springs are in the right order on the LPR piston.
- Ensure the 'O' rings are present on the manifold prior to its replacement.
- Ensure the 'O' ring is present on the flash tank prior to its replacement.

RAM STROKE ADJUSTMENT

- Ensure the Tab key is in or in SAFE mode
- Ensure the gas supply is ON.
- Ensure bolt is fully retracted. Remove the breech block pull knob by gently pulling and rotating 90 degrees.
- Remove the countersunk screws holding the back plate, using suitable metric Allen key.
- Carefully lift the back plate off. **Caution: there are wires attached to the back plate and a spring is located under the back plate. Care must be taken so that the wires are not pulled or trapped during maintenance.**
- Retract breech block lock pin and spring.
- Using circlip pliers or the ram location tool (optional accessory) rotate ram assembly clockwise until slight resistance is felt in opening the breech block. If rotated too far the breech will not open so rotate counterclockwise and repeat operation. **Note: The ram must always be rotated clockwise when setting.**
- Replace the breech block lock pin, spring, back plate & breech block pull knob. **Caution: ensure that no wires become trapped.**

RAM SNAP RING ADJUSTMENT / REPLACEMENT

- Follow ram stroke adjustment procedure.
- Ensure the ANGEL LCD™ is degassed and in "SAFE" mode.
- Remove snap ring nut using suitable metric Allen key. Ensure that the ram does not rotate by holding it in place with circlip pliers or the ram alignment tool (optional accessory)
- Remove the snap ring 'O' ring with a suitable pick if worn or damaged and replace with a new replacement.
- Apply a small amount of low strength loctite to the snap ring screw. Replace the ram snap ring nut ensuring the Ram assembly does not rotate by using circlip pliers or the ram alignment tool (optional accessory) until slight resistance felt.
- Gas up the ANGEL LCD™ and switch the ANGEL LCD™ ON. See diagrams 18 - 19 and 24

⚠ WARNING : Adhere strictly to all safety instructions & guidelines.

- Fire the ANGEL LCD™ whilst rotating the snap ring screw clockwise until the ANGEL LCD™ ceases to fire, now rotate the snap ring screw counterclockwise ¼ of a turn. Ensure the ANGEL LCD™ fires.
- Replace the remaining parts as per ram stroke adjustment. **Caution: ensure no wires become trapped.**

TRIGGER ADJUSTMENT

The trigger can be adjusted for 2 parameters. The trigger return stroke and the trigger over travel. These adjustments allow you to have a total trigger movement as little as ¼ of a mm. Setting the differential between these 2 parameters too small can cause erratic trigger operation. (See trigger adjustment diagram & wiring connections diagram see pages 22 and 26).

⚠ WARNING : Never adjust your trigger so fine that accidental discharge can occur due to shock loads or vibration.

- Remove the left-hand side grip cheek cover by removing the 3 screws using a suitable metric Allen key.
- Unplug the battery and solenoid plugs.
- Remove the 2 grip frame screws holding the frame to the body using a suitable metric Allen key.
- Remove the frame from the body. Remove the trigger return spring from the top of the trigger. You now have access to the trigger adjustment screws.
- Any adjustment to these screws we recommend removing and applying a small amount of Loctite low strength thread lock.

TRIGGER ADJUSTMENT CONTINUED

- The screw nearest to finger location that projects above the trigger controls the over travel. Using a suitable metric Allen key adjust to suit. Counterclockwise reduces the over travel. **Caution: There must be sufficient over travel to activate the microswitch.**
- The screw that is recessed into the trigger below the return spring controls the return stroke. Using a suitable metric Allen key adjust to suit. Clockwise reduces the return stroke. **Caution: There must be sufficient return stroke to reset the microswitch.**
- By replacing the trigger spring and offering the frame to the body you can verify your settings by pulling the trigger, you will hear an audible "click" from the microswitch verifying its operation.
- Replace grip frame screws and wiring connectors into the PCB. **Caution: Do not trap any wiring, or the trigger return spring between the body & frame.**
- Replace grip cheek cover screws using a suitable metric Allen key adjust to suit.

TESTING PNEUMATICS / ELECTRONICS

⚠ WARNING : Adhere strictly to all safety instructions & guidelines.

The design of the ANGEL LCD™ can be divided into two elements, which enable you to evaluate where a problem may have occurred. To evaluate the pneumatics follows the procedure listed. (See wiring connections diagram).

- Ensure the ANGEL LCD™ is 'LIVE' and gassed up.
- Remove the 2 fixing screws that hold the sight rail on using suitable metric Allen key.
- Gently lift off the sight rail.
- Using a pencil, press and hold the orange button on top of the 14-way valve. The pneumatics will now operate as all electronics are bypassed, The ANGEL LCD™ should fire a shot with the bolt remaining in the forward position
- On removing the pencil the pneumatics will reset with the bolt returning to its rest position. This shows that pneumatics have functioned correctly.
- Should the pneumatics not operate this indicates that there is a pneumatics problem.
- Should the ANGEL LCD™ have not fired when the trigger is pulled prior to this test, this indicates an electronic problem. See page 23 for the test point location.

FAULT FINDING

ANGEL WILL NOT FIRE?

- IS AIR/NITROGEN PRESENT - See gassing up the ANGEL LCD™.
- IS BATTERY PACK CHARGED? - See charging the ANGEL LCD™.
- IS THE ANGEL IN 'SAFE'? - See switching the ANGEL LCD™ On.
- IS TAB KEY IN? - See switching the ANGEL LCD™ On.
- IS THE TRIGGER ADJUSTED CORRECTLY? - See trigger adjustment.
- IS BOLT JAMMED FORWARD? - Clear blockage from breech.
- IS RAM SNAP RING TOO TIGHT? - See ram snap ring adjustment.
- ARE PNEUMATICS WORKING? - See testing pneumatics.
- IS CIRCUIT BOARD WORKING? - See testing electronics.

VELOCITY TOO LOW / HIGH?

- IS INLET PRESSURE FROM HIGH PRESSURE REGULATOR SET CORRECTLY? - See gas source.
- IS VELOCITY ADJUSTER SCREW SET CORRECTLY? - See velocity adjustment.
- IS BOLT STICKING? - Check anti-double ball.
- IS LPR SET CORRECTLY? - See LPR adjustment.
- IS VALVE DWELL SET CORRECTLY? - See dwell adjustment.
- IS RAM SET CORRECTLY? - See ram stroke adjustment.
- IS SNAP RING SET CORRECTLY? - See ram snap ring adjustment.

CHOPPING PAINTBALLS?

- IS SUITABLE WORKING HOPPER FITTED? - See accessories.
- IS RATE OF FIRE SET TOO HIGH? - See MROF adjustment.
- IS THE ANTIDouble BALL PRESENT? - Clean or replace.

FIRING TOO SLOW?

- IS RATE OF FIRE SET CORRECTLY? - See MROF adjustment.

EXCESSIVE NOISE / GAS CONSUMPTION

- IS VALVE DWELL SET CORRECTLY? - See valve dwell adjustment.
- IS LPR PRESSURE SET CORRECTLY? - See LPR adjustment.
- IS EXHAUST VALVE WORN? - See exhaust valve replacement.

GAS LEAKING?

- FROM BACK COVER? - See testing pneumatics / electronics.
- FROM GAS JOINTS? - Check all fittings.
- FROM EXHAUST VALVE? - See exhaust valve removal.
- FROM RAM? - See testing pneumatic.

ELECTRONIC DISPLAY PROBLEMS

- RANDOM DIGITS? - Remove battery plug or insert tab key to reset.
- GHOSTING OF DISPLAY? - Charge battery.
- DATA LINK NOT WORKING? - Reset to factory defaults.
- NO DISPLAY? - Charge battery.

SPARE PARTS

GRIP FRAME / TRIGGER PARTS

LCD 010 - GRIP FRAME ASSEMBLY (TRIGGER /FRAME /GRIPS & WINDOWS)
LCD 011 - GRIP CHEEK WITH WINDOWS
LCD 012 - TRIGGER SPRING
LCD 013 - TRIGGER ASSEMBLY
LCD 014 - GRIP FRAME SCREWS 2 OFF
LCD 015 - GRIP CHEEK SCREWS 6 OFF

FLASH TANK / MINI REGULATOR PARTS

LCD 016 - FLASH TANK
LCD 017 - FLASH TANK FIXING SCREW
LCD 018 - FLASHTANK SEAL
LCD 019 - FLASH TANK MANIFOLD
LCD 020 - FLASH TANK MANIFOLD SEALS
LCD 021 - FLASH TANK MANIFOLD FIXING SCREW
LCD 022 - MINI REG ASSEMBLY

BREECH BLOCK LOCK PARTS

LCD 023 - BREECH BLOCK LOCK PIN
LCD 024 - BREECH BLOCK LOCK PIN SPRING
LCD 025 - BREECH BLOCK RELEASE KNOB

BOLT PARTS

LCD 026 - BOLT ASSEMBLY

EXHAUST VALVE / LPR PARTS

LCD 027 - EXHAUST BODY LOCK PIN
LCD 028 - EXHAUST VALVE GUIDE
LCD 029 - EXHAUST VALVE STEM
LCD 030 - EXHAUST VALVE SPRING
LCD 031 - EXHAUST BODY SEAL (FRONT)
LCD 032 - EXHAUST BODY SEAL (REAR)
LCD 033 - LPR ASSEMBLY (BODY / SPRINGS / SHIMS / PISTON)
LCD 034 - LPR LOCK PIN

ELECTRICS / ELECTRONICS

LCD 035 - LCD DISPLAY ONLY (NO PCB BOARD)
LCD 036 - CIRCUIT BOARD ONLY (NO LCD)
LCD 037 - CIRCUIT PCB BOARD & LCD ASSEMBLY
LCD 039 - CHARGER
LCD 040 - BATTERY PACK / BUMPER
LCD 041 - 14 WAY ASSEMBLY (NO MANIFOLD)
LCD 042 - 14 WAY MANIFOLD
LCD 043 - TAB KEY

MAIN BODY PARTS

LCD 044 - ANTI DOUBLE BALL ASSEMBLY
LCD 045 - BARREL
LCD 046 - BACK PLATE
LCD 047 - PAINT FEED TUBE
LCD 048 - BODY & BREECH BLOCK
LCD 049 - SIGHT RAIL
LCD 050 - END PLUGS LPR & BATTERY
LCD 051 - 14 WAY CLAMP PLATE

SPARE PARTS CONTINUED

RAM ASSEMBLY PARTS

LCD 052 - RAM ASSEMBLY
LCD 053 - RAM BODY SEALS
LCD 054 - SNAP RING SEAL

ACCESSORIES

LCD 055 - SERVICE TOOL KIT
LCD 056 - HOPPER ADAPTOR KIT
LCD 057 - EXTERNAL STAINLESS STEEL SCREW KIT
LCD 058 - 'O' RING KIT
LCD 059 - BREECH BLOCK PULL KNOBS COLOURED 5 OFF
LCD 060 - DATA LINK CONTROL BOX

USEFUL CONVERSIONS

Listed are some useful conversions relating to pressure, velocity, mass & distance.

PRESSURE

1 atm = 1.01325 bar
1 atm = 14.6959 psi
1 bar = 14.5038 psi
1 psi = 0.0689476 bar

VELOCITY

1 Ft/s = 0.3048 Mt/s
1 Ft/s = 0.000189394 mph
1 Mt/s = 3.28084 Ft/s
1 Mt/s = 2.23694 Mph
1 Mt/s = 3.6 Km/hr
1 Ft/s = 6.681818 Mph

MASS

1 g = 0.05274 oz
1 Kg = 2.20462 lb
1 oz = 0.0283495 Kg

DISTANCE

1 mm = 0.0393701Inch
1 Inch = 25.4 mm
1 thou = 25.4 micron
1 micron = 0.0393701thou

TERMS OF WARRANTY

EEC / R.O.W. EXCLUDING USA & CANADA

Subject to the conditions set out below WDP warrants that the ANGEL™ will correspond to its specification at the time of delivery and will be free from defects in materials and workmanship for a period of six months from the date of purchase.

WDP gives this warranty subject to the following conditions:

- Proof of purchase is required in all warranty claims;
- Warranty is not transferable.
- The company shall be under no liability in respect of any defect arising from fair wear and tear.
- Seals, batteries, wiring circuit boards, LCD displays and exhaust valves are not covered by this warranty. Wilful damage, negligence, abnormal working conditions, weather, accident, tampering, failure to follow manufacturer's instructions (whether oral or in writing), misuse or alteration or repair of the ANGEL™ without the company's written approval will invalidate this warranty and the company shall be under no obligation whatsoever to the purchaser in respect of any of the above breaches of this warranty.
- The above warranty does not extend to parts, materials or equipment not manufactured by the company, in respect of which the purchaser shall only be entitled to the benefit of any such warranty or guarantee as given by the manufacturer to the company.
This warranty does not cover the following:
 - Repairs, alterations or replacements not authorised by the manufacturer
 - The gradual reduction in performance linked to the age of the ANGEL™ or usage
 - Anything caused directly or indirectly by vandalism or theft
 - Any damage to parts which are recalled by the Manufacturer
 - Any loss damage or failure, which a qualified engineer appointed by the Manufacturer, believes could have been avoided or was totally or partly caused by a lack of maintenance.

Subject as expressly provided in these conditions and except where the goods are sold to a person dealing as a consumer (within the meaning of the Unfair Contract Terms Act 1977) all warranties, conditions or other terms implied by statute or common law are excluded to the fullest extent permitted by law.

Where the goods are sold under a consumer transaction (as defined by the Unfair Terms in Consumer Contracts Regulations 1994 S13159) the statutory rights of the purchaser are not affected by these conditions. Carriage charges in relation to warranty claims shall be borne by the customer.

Where any valid claim in respect of the ANGEL™ is based in the quality or condition of the ANGEL™ or its failure to meet specification, and such valid claim is notified to the company in writing and is in accordance with the company's standard terms and conditions of sale the company shall be entitled to repair or replace the goods or the part in question free of charge or, at the company's sole discretion, refund to the purchaser the price of the goods (or a proportionate part of the price) but the company shall have no further liability to the purchaser.

Except in respect of death or personal injury caused by the company's negligence, the company shall not be liable to the purchaser by reason of any representation, or any implied warranty, condition or other term, or any duty at common law, or under the express terms of this guarantee, for any direct or indirect, special or consequential loss or damage, whether to persons or property, costs, expenses or other claims for compensation or damages whatsoever (whether caused by the negligence of the company, its employees or agents or otherwise) which arise out of or in connection with the supply of the ANGEL™ its use, or misuse, or resale by the purchaser, or any individual, and the entire liability of the company under or in connection with the purchase or use or misuse of the ANGEL™ shall not exceed the purchase price of the ANGEL™. Purchaser agrees to adhere strictly to all warnings and safety procedures and the contents of the Operator's Manual.

The laws of England shall govern this warranty and the purchaser agrees to submit to the non-exclusive jurisdiction of the English courts.

The supply and purchase of the ANGEL™ is subject to the company's standard terms and conditions of sale, a copy of which is available on request. ANGEL™ patents applied for, design rights and all rights reserved. The ANGEL™ is marketed and distributed by WDP Ltd a company registered in England No. 2114341.

TERMS OF WARRANTY EEC / R.O.W. EXCLUDING USA & CANADA CONTINUED

No warranty is given to parts not manufactured by the Manufacturer and all liability for loss damage or injury is excluded.

This warranty must be construed and read in conjunction with the products terms and conditions of sale.

To make a warranty claim, buyer must first contact the nearest authorised ANGEL™ Service Centre for instructions. A list of authorised ANGEL™ Service Centres may be obtained through WDP website www.wdp-paintball.com, or by contacting WDP by mail at WDP, Metro Triangle, 221 Mount Street, Nechells, Birmingham, England, B7 5QT, or by fax at + (44) (0) 121 327 3967, or by calling + (44) (0) 121 328 2228.

WDP EXPRESS WARRANTY **USA / CANADA ONLY**

1. General Express Warranties.

WDP warrants to the buyer who is purchasing to place into use ("Buyer") only, that the ANGEL™ ("Product") shall be free from material manufacturing defects in materials and workmanship for six months from the date of purchase, subject to the requirements, disclaimers and limitations of this Warranty. This is not a Warranty of performance, but a limited Warranty as to the condition of the Product at the beginning of the Warranty period, this Warranty is only against such defects and not against any other failures such as, but not limited to, those due to wear and tear, exposure to the elements, unusual operating environments, misuse, negligence, accident, alteration or repair in any respect which, in the judgement of WDP adversely affects the condition or operation of the Product. Normal maintenance and perishable items such as seals, batteries, wiring, indicator lamps and exhaust valves are excluded from this limited Warranty against defects. This Warranty is not transferable and it may not be waived or expanded except in writing signed by WDP. The terms and limitations of this Warranty shall also apply to any additional goods or information, which may be distributed by WDP relating to the ANGEL™

2. Disclaimer and Limitation of Express and Implied Warranties.

There are no express Warranties other than those contained in this Warranty. Whether or not the Product is to be used exclusively by Buyer, there shall be no third party beneficiaries to this Warranty herein. NO WARRANTY IS PROVIDED TO DISTRIBUTORS OR DEALERS EXCEPT AS MAY BE EXPRESSLY PROVIDED IN A SEPARATE AGREEMENT OF SALE. All descriptions, illustrations of the Product and other information in catalogues, brochures and price lists or otherwise provided by WDP or others are intended for general information only. WDP is not responsible for any errors or omissions therein or for any loss or damage resulting from reliance on them. WDP does not warrant that the Product is in compliance with any law or industry standards, guidelines or procedures. WDP Ltd standard terms and conditions of sale also apply if Buyer is a direct purchaser from WDP. WDP DISCLAIMS ALL IMPLIED WARRANTIES INCLUDING, BUT NOT LIMITED TO, THOSE OF FITNESS FOR A PARTICULAR PURPOSE AND MERCHANTABILITY.

3. Remedy and Limitation of WDP liability.

Defective or non-conforming Product or parts thereof discovered and returned to WDP, freight prepaid, with proof of purchase, during the Warranty period shall be repaired or replaced by WDP without any additional charge and shipped to Buyer, FOB WDP. In lieu of repair or replacement, if WDP elects, WDP may, upon return of such product and making a determination of non-conformity or defect, keep the product and refund the purchase price paid by Buyer. Buyer's remedies shall be limited (even in the event of WDP default of its Warranty obligations) exclusively to those provided in this Warranty. UNDER NO CIRCUMSTANCES SHALL WDP OR ANY SUPPLIER, DISTRIBUTOR, DEALER, OR OTHER PERSON BE LIABLE FOR EXEMPLARY, PUNITIVE, CONSEQUENTIAL OR INCIDENTAL DAMAGES, NOR FOR ANY AMOUNT IN EXCESS OF THE BUYER'S PURCHASE PRICE. Buyer waives any causes of action or theories of liability including, but not limited to, those arising under contract, tort, strict liability, Product liability, statutes, or otherwise, except as to those specifically provided by the Uniform Commercial Code (as adopted in Michigan) as excluded, modified and limited in this warranty.

UPDATE

The specification & photographs in this material are for general guidance purposes only. Our products are continuously updated and changes may be made to specifications, design, or appearance from time to time. For the latest specification, virtual products and on line technical support we recommend that you visit our web site.

www.wdp-paintball.com

The ANGEL™ is a registered trade mark. Design rights & all rights reserved. All patterns drawings photographs instructions or manuals remain the intellectual property of the manufacturer. Patents pending. All rights will be strictly enforced

PERSONAL DETAILS RELATING TO YOUR ANGEL™

BODY / BLOCK SERIAL No:

--	--	--	--	--

UNIQUE ELECTRONIC ID No:

--	--	--	--	--	--	--	--

YOUR UNIQUE PIN No:

--	--	--	--	--

MODEL:

PURCHASED FROM:

DATE: COUNTRY: CITY:

STATE: ZIP: