



VANQUISH GT

EMPIRE MARKER SYSTEM



www.empirepaintball.com



⚠ WARNING!

This is not a toy. Misuse may cause serious injury or death. Eye protection designed specifically for paintball must be worn by the user and persons within range. Recommend 18 years of age or older to purchase. Persons under 18 years of age must have adult supervision. **READ THIS MANUAL BEFORE USING.**

⚠ WARNING! PAINTBALL GUNS AND PAINTBALL GUN ACCESSORIES ARE NOT TOYS!

- Careless use or misuse may result in serious bodily injury or death!
- Eye protection designed for paintball must be worn by the user and all persons within range.
- Not for sale to persons under 18 years of age.
- Must be 18 years of age or older to operate or handle any paintball gun and paintball gun accessories without adult or parental supervision.
- Read and understand all cautions, warnings, and operating manuals before using any paintball gun or paintball gun accessory.
- Do not aim paintball gun at eyes or head of people or at animals.
- Paintball guns are to be used with Paintballs only.
- To prevent fire or shock hazard, do not expose unit to rain or moisture.
- To prevent fire or shock hazard, do not immerse unit in liquids.
- To prevent fire or shock hazard, do not disassemble any electronic paintball device.
- The disposal of the battery used to power this product may be regulated in your area.
- Please conform to all local or state regulations with regard to battery disposal.
- Use common sense and have fun.

Any tampering with the unit voids your warranty. There are no consumer serviceable parts inside the unit. The use of non factory authorized components within this product may cause a critical failure, fire or shock hazard.

IN NO EVENT SHALL SELLER BE LIABLE FOR ANY DIRECT, INCIDENTAL OR CONSEQUENTIAL DAMAGES OF ANY NATURE, OR LOSSES OR EXPENSES RESULTING FROM ANY DEFECTIVE PRODUCT OR THE USE OF ANY PRODUCT.

WARNING: This product contains one or more chemicals that are known to the State of California to cause cancer and birth defects or other reproductive harm. *Wash hands after handling.* You must be at least 18 years of age to purchase this product. This product may be mistaken for a firearm by law enforcement officers or others. Altering the color of the product or brandishing the product in public may be considered a crime.

Rules For Safe Marker Handling

IMPORTANT: Never carry your Empire Vanquish uncased when not on a playing field. The non-paintball public and law enforcement personnel may not be able to distinguish between a paintball marker and a firearm. For your own safety and for those in the area and to protect the image of the sport, always carry your Empire Vanquish in the marker case or a suitable container.

Safety and safe marker handling are the most important aspects of paintball sports. Please practice each of the following steps with an unloaded marker before attempting to operate your marker with an air source and paintballs. Read this entire manual before loading, or installing an air cylinder, or in any way attempting to operate the marker.

READ OWNER'S MANUAL BEFORE USING

- This is not a toy, use with caution.
- Treat every marker as if it were loaded.
- Never look down the barrel of a paintball marker.
- Keep your finger off the trigger until ready to shoot.
- Never point the marker at anything you don't wish to shoot, including fragile objects such as windows.
- Keep the marker turned off until ready to shoot.
- Keep the barrel-blocking device in/on the marker's barrel when not shooting.
- Always remove paintballs and the air source before disassembly.
- After removing air source, point marker in safe direction and discharge until marker is confirmed as degassed.
- Store the marker unloaded and degassed in a secure place.
- Follow warnings listed on the air source for handling and storage
- Every person within range must wear eye, face, and ear protection designed specifically to stop paintballs and meeting ASTM standard F1776.
- Always measure your marker's velocity before playing paintball and never shoot at velocities in excess of 300 feet-per-second (91.44 meters).
- Remember that the ultimate safety device is you, the operator.

For manuals in other languages and warranty details, go to: paintballsolutions.com



TABLE OF CONTENTS

INTRODUCTION..... 4

QUICK SETUP..... 5

 Driver XX Barrel..... 5

 Vanquish Power On/Off..... 6

 Tank Installation..... 6

 Installing a Loader and Paintballs..... 7

 Firing the Empire Vanquish..... 7

VANQUISH SETUP AND ADJUSTMENT..... 7

 Battery Replacement and Life Indicator..... 7

 Pressure and Velocity Adjustment..... 8

 Trigger Adjustment..... 8

 Cold Weather Set-Up..... 9

ELECTRONIC BOARD FUNCTIONS..... 10

 Live Mode..... 10

 Main Menu..... 11

 Config Menu..... 11

 System Menu..... 14

 Tournament Lock..... 17

VANQUISH MENU TREE..... 18

VANQUISH PC SOFTWARE..... 20

 Software Installation..... 20

 Using the Vanquish USB Tool Software..... 21

 Vanquish Boot Screen Editor Software..... 23

 Vanquish PC Software Troubleshooting..... 23

GENERAL MAINTENANCE..... 24

 External Cleaning..... 24

 Barrel..... 24

 Firing Engine Assembly..... 24

 Maintenance of Firing Engine..... 25

 Cleaning Eyes/Ball Detent..... 26

 Regulator..... 27

SPLITTING THE BODY..... 27

 Trigger Maintenance..... 27

TROUBLESHOOTING GUIDE..... 28

PART DESCRIPTION DIAGRAMS..... 31

WARRANTY INFO..... 34





INTRODUCTION

Empire Paintball has created the finest paintball marker in the proud history of Empire products. The Vanquish is the pinnacle of intelligent marker design incorporating cutting edge technology within a proven marker platform.

Hardware Features

- Pressure balanced Spool Valve firing engine
- 5 way joystick navigation control
- Super bright 2000:1 contrast ratio 1" OLED Display, White on Black background
- Optional "Soft-Shot" bolt
- Built in temperature compensated precision Pressure Transducer for on screen pressure read-out. No bulky external gauges or special pressure tester kit needed
- Double eye breech sensor system
- Low force trigger switch with 4-way adjustable dual-bearing trigger
- Rubber tipped spring assisted Bolt is soft on paint
- 2.7KHz Beeper to provide audio feedback
- Nano Watt XLP Flash microcontroller performing up to 16 MIPS (million instructions per second) provides highly accurate timing while not eating your battery
- Single hex tool for all maintenance needs
- Quick strip bolt
- Gas through grip frame
- Ambidextrous feedneck with adjustment
- ON/OFF ASA with Regulator

Software Features

- "Slick Assistant" Lubricant Monitoring System alerts you when you need to lube your marker
- Marker to PC enabled with no special accessories needed. Upgrade firmware, change settings, and make custom boot screens with the downloadable PC software
- RF Upgradeable for seamless marker to loader communication
- Interrupt based firmware gives an ultra responsive feel when firing. Virtually no lag time between trigger pull and response time
- Super intuitive menu system that makes changing settings quick and easy
- 3 customizable User Configurations to quickly and easily switch style of play in seconds
- Training Mode with beeper feedback for players to practice their Trigger Speed without need for air or paintballs

- User adjustable Anti-Bolt Stick settings makes First Shot Drop Off a thing of the past
- Preset Tournament Firing Modes to keep you legal at any major tournament deries
- Customizable ramping and full-auto modes to max out your marker's performance
- Resettable Shot Counter
- Calculated Average ROF and Peak ROF achieved can be displayed on screen

Empire Vanquish Specifications

- Model: Empire Vanquish
- Barrel: Barrel: 14" Ported Aluminum Driver XX
- Caliber: .68
- Action: Electro-pneumatic Spool Valve
- Air Source: Compressed Air or Nitrogen (NoCO2)
- Battery: One 9-Volt (Alkaline Only)
- Main Body Material: Aerospace 6061 Aluminum
- Weight: 35 ounces (998 grams)

Included With Your Empire Vanquish:

- Driver XX 5pc barrel kit with 7.5" control bores in sizes (.682, .685, .688, .691)
- Neoprene Marker Carry Case
- 3/32" Hex Wrenches - Driver Handle, L-shaped
- Lubricant
- Empire Barrel Bag
- Empire Stickers
- One 9-Volt Alkaline Battery
- Quick Start Manual
- USB Cable



QUICK SETUP

Empire Driver XX Barrel

The Empire Driver XX Barrel is included with the Empire Vanquish marker. The Driver XX is a two-piece barrel that consists of a front section (tip), a back section (back) that has four sizing options. The different sized backs are used to match the size of the paintball to the barrel and create the most accurate and efficient barrel system available.

To determine the correct bore size:

1. Assemble the barrel and choose a sized barrel back.
2. Select 5 - 10 paintballs of the same type you will be using to play
3. Place a ball into the end of the barrel
 - a. Tip the barrel, if the ball rolls through without any outside force, switch to a smaller bore size. The barrel backs have the size engraved onto the end of each one (sized .678, .683, .688, .693)
 - b. If the ball barely fits into the barrel and you can't blow it out (easily) switch to a larger bore size.
4. When the ball is blown out of the barrel listen for a small pop sound. If you can blow the ball out of the barrel without blowing hard you should have a good ball-to-bore match.



Note: The more you exhale through the barrel, the more moisture can accumulate within the barrel back and affect your testing. If you notice that the ball is starting to stick, or see a buildup of moisture, clean and dry the barrel before continuing with the selection of bore sizes.

BARREL INSTALLATION

- The Vanquish and the supplied Driver XX barrel use Autococker threads.
- Insert the threaded end of the barrel tip into the open section of the barrel back.
- Make sure the Vanquish is de-gassed, loader removed, no paintballs in the feedneck or breech, and the marker is turned OFF prior to installing barrel.
- While pointing the marker in a safe direction, place the threaded end of the barrel into the front opening of the marker.
- Turn the barrel clockwise until it stops (Do not over tighten).
- Install the included barrel-blocking device. This can be barrel bag or other such device that prevents accidental discharge of paintballs.



Vanquish Power On/Off

- Turn Marker ON - Press and hold the CENTER of the Directional Pad (the black button/joy stick located under the screen) until the screen illuminates to turn the board/marker ON. The Boot Up Splash Screen will display for 3 seconds. You are now in LIVE Mode (see below for more details) and the marker is ready to fire.
- Turn Marker OFF - Press and hold CENTER on Directional Pad (D-pad) to enter the MAIN Menu, release D-Pad and then press CENTER on D-Pad when the display reads OFF to turn board off.
- Automatic Off feature - The Empire Vanquish also has an automatic off feature. If you accidentally leave your marker powered up, it will shut itself off after approximately 10 minutes of inactivity.

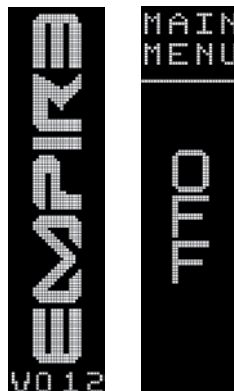

Note: the Auto Off time and the Boot Screen Display are adjustable in the SYSTEM Menu

Tank Installation

The Empire Vanquish is designed to work with compressed air/nitrogen only. **Do not use CO₂**, as it will damage your marker. The Empire Vanquish utilizes a fully functional regulator at the bottom of the grip frame that doubles as an On/Off ASA (Air Source Adapter) or receiver for a standard threaded preset output compressed air system. If you are using an adjustable output regulator system, the output pressure should be 500-650 psi.

WARNING

- Remember compressed air or nitrogen systems can be extremely dangerous if misused or improperly handled. Use only cylinders meeting D.O.T., TC or regionally defined specifications.
- Never add any lubricants or greases into the fill adapter on your tank regulator.
- Do not install compressed air or load paintballs into your Empire Vanquish until you feel completely confident with your ability to handle your Empire Vanquish safely.

BEFORE PRESSURIZING YOUR EMPIRE VANQUISH

- Check to make sure that you and anyone within range are wearing eye protection designed specifically for paintball.
- Double check that all screws are tightened and no parts are loose before installing your tank.

- Make sure the Firing Engine system is properly locked in place.
- Ensure you have a barrel plug, barrel sock, or other specifically designed barrel blocking device in place.
- Make sure there are no paintballs in the marker and the power is off.

PRESSURIZING YOUR EMPIRE VANQUISH

- Flip the regulator's On/Off ASA lever forward so it's pointing toward the front of the marker.
- Install a compressed air tank, by screwing it in clockwise; making sure it's fully threaded into the ASA.
- Flip the On/Off ASA lever back so it's flush with the regulator and pointing toward the rear of the marker. The marker will become pressurized.





DE-PRESSURIZING YOUR EMPIRE VANQUISH

- Make sure a barrel-blocking device is installed in/on the end of the barrel.
- Turn the Empire Vanquish off using the D-Pad as explained above.
- Remove loader and all paintballs from marker.
- Flip the On/Off lever forward and allow the gas to vent from the regulator.
- Air may remain within the marker once the regulator is vented. While the barrel blocking device is still installed, turn your Vanquish on, turn the eyes off and pull the trigger a few times to deplete all remaining air.
- Read the pressure rating and make sure the pressure reads “LOW”.
- Remove your air cylinder by slowly and carefully unscrewing it counter-clockwise.

Installing a Loader and Paintballs

The Empire Vanquish uses .68 caliber, water-soluble paintballs, readily available at paintball pro-shops, commercial playing fields, and many sporting goods stores. The paintballs feed from the loader through the neck and into the breech of the marker.

The Empire Vanquish comes equipped to accept standard-gravity feed loaders as well as most agitating and force-feed loaders. Open the clamp lever and place the loader neck directly into the marker feed neck. Align the loader in line with the marker so the nose points in the same direction as the barrel. Close the lever, noting that it might be necessary to adjust the feed neck's clamping screw to get a snug fit on your loader.

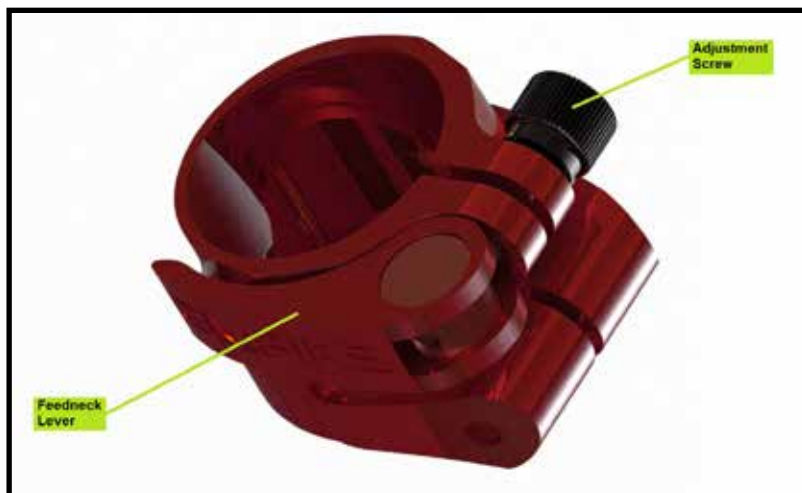

Firing the Empire Vanquish

Keep your finger out of the trigger guard and away from the trigger, point the muzzle of your marker in a safe direction at all times during this process. Be sure your goggles are securely in place and make sure the Vanquish marker is off.

Warning: Everyone within firing range should always use ASTM approved eye and face protection in the presence of live paintball markers.

- Place the empty loader onto the marker. Be sure that it is securely mounted in place
- Install and apply the compressed gas, pressurizing the marker
- Put the paintballs into the loader
- Remove the barrel plug, sock or barrel-blocking device
- Aim the Vanquish in a safe direction.
- Turn the Vanquish ON: Press and hold the CENTER of the D-Pad to turn board/marker ON
- Aim the Vanquish at the target
- Pull the trigger with a smooth squeezing motion

Caution: When the game you are playing is over, remember to place the barrel blocking device onto your barrel and turn the marker off.

Vanquish SETUP AND ADJUSTMENT

Battery Replacement and Life Indicator

The Empire Vanquish requires a single 9-volt battery as the electronic power source. The use of brand-name batteries is highly recommended. The 9-volt battery is located within the grip and is accessed through the removal of the grip panel by using the 3/32" hex wrench to remove the grip screws. Confirm that the marker is OFF before changing or installing the battery.

If there is already a battery in the grip, carefully disconnect the battery from the battery harness, and then connect a fresh 9-Volt battery to the harness. Make sure that there are no abrupt kinks in the wires and that they are comfortably seated. Do not force into place. Then re-install the grip and secure with the grip screws. The Empire Vanquish also has a battery life indicator visible on the screen in Live Mode. The battery icon will show the power level remaining in the battery.

Note: Some rechargeable batteries may be too large for the Empire Vanquish battery compartment. If they don't fit, please don't force them as this may cause damage.





Optional Soft-Shot Bolt

You will notice that your Vanquish comes with 2 different Bolts. One Bolt is installed on your marker and the other was shipped as a separate component. The red anodized Bolt (not installed in the marker) is called the Soft-Shot Bolt. This Bolt is designed so that while in the firing cycle, the air is restricted from venting, so that when the Bolt returns, it hits an air cushion. This creates a softer shot, but at the expense of a lower cycling speed and fewer balls-per-second (approx. 13.5 bps). Please note that due to the restrictions of most tournaments, playing with this lower cycle rate is not a concern and some players prefer the softer feeling shot. To insure complete satisfaction with the Vanquish in any playing condition, we offer you both Bolts.

See the GENERAL MAINTENANCE section for installation instructions

Pressure and Velocity Adjustment

The velocity can be adjusted by adjusting the pressure. Locate the Pressure Adjustment Screw and using the 3/32" Hex wrench, turn the screw clockwise (inward) to increase the pressure (and velocity). Turn the screw counter-clockwise to decrease the pressure.

Turn on the Vanquish and enter the LIVE mode on the display (see below for more detail). Press and hold the D-pad to the Left or Right for 1 second at a time to change displayed information. Repeat this process until the display cycles to pressure reading. This visual indicator will help determine the correct pressure/velocity you desire.

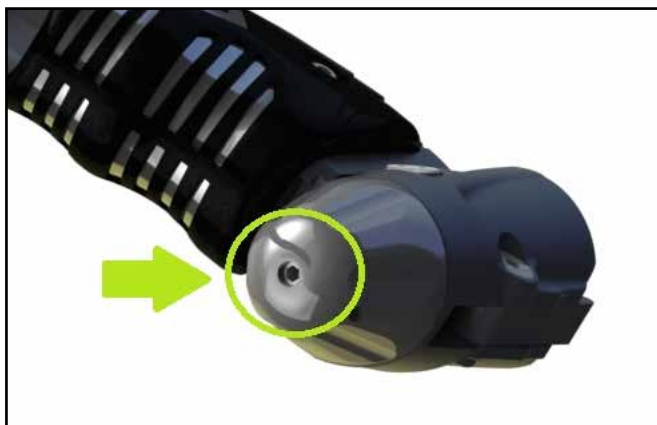

Trigger Adjustment

There are four adjustments that can be made on the on the trigger. Use the 3/32" hex wrench to make any desired adjustments:

- A. Magnetic Tension - this affects how "hard" the pull of the trigger is
- Turning the adjustment screws "in" or clockwise will increase the force needed to pull the trigger
- B. Forward Travel - This adjusts the position of the trigger when not being fired
- Turning the adjustment screws "in" or clockwise will decrease the trigger length of travel
- C. Stop - This adjusts the farthest position the trigger will travel when depressed
- Turning the adjustment screws "in" or clockwise will decrease the travel of the trigger by having the trigger stop sooner
- D. Activation Point - This adjusts the position where the trigger pull registers a shot
- Turning the adjustment screws "in" or clockwise will decrease the travel of the trigger needed before the Vanquish registers a shot

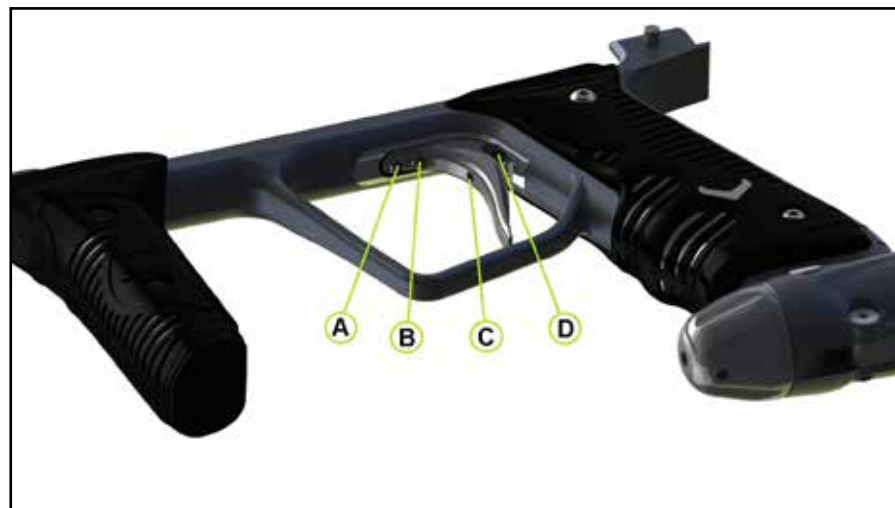



How to Setup the Vanquish for Cold Temperatures

Before using the Vanquish in cold weather conditions (typically at or below 45°F) there is extra care that should be taken. The balanced engine of the Vanquish exerts low forces when cycling the bolt, giving the marker it's the soft feel when shooting, however lubricant in cold temperatures can become sticky, and o-rings can shrink, therefore there are specific procedures that must be followed to ensure the Vanquish continues to perform reliably.

- 1) **FRESH BATTERY** - Always use a fresh battery for play in the cold. If your battery reads less than $\frac{3}{4}$ full at the beginning of the day it should be changed before start of play. If your battery reaches less than $\frac{3}{4}$ full during the day it may need to be changed before the end of the day
- 2) **ADD PAINTBALL MARKER OIL** - Follow typical lubricating procedure for applying grease to the bolt. Once grease is applied to the bolt add a several (3-4) drops of paintball marker oil, such as Gold Cup and mix evenly with grease throughout bolt. Adding oil to the normal grease will reduce stickiness of the grease allowing the Vanquish to cycle more feely.
- 3) **INCREASE DWELL** - It is normal to increase the dwell 5.0 or more milliseconds above normal level in cold temperatures. Should bolt stick reappear throughout the day you should increase the Dwell setting more. It is normal to need to readjust the Dwell several times throughout the day to ensure reliable cycling. Higher Dwell settings will not damage your marker. Since there is more stiction in cold weather the Dwell setting on the Vanquish circuit board may need to be increased in order provide consistent reliable cycling. The Dwell setting controls how long the solenoid is powered and therefore how long the bolt will be pushed forward. The Vanquish will cycle more slowly in cold weather and therefore will need to have the bolt pushed forward for a longer amount of time.

4) **INCREASE ABS DWELL, DECREASE ABS WAIT TIME** - It is normal to increase ABS Dwell to 30ms minimum and decrease ABS Wait Time to 10s in cold weather. Should bolt stick reappear throughout the day you should increase the ABS Dwell setting more. It is normal to need to readjust the ABS Dwell several times throughout the day to ensure reliable cycling. Higher ABS Dwell settings will not damage your marker.

5) **USE BUNA O-RING ON BOLT**- A Buna o-ring can be used in place of o-ring 7 (size 016/70duro, see diagram above). Research has shown that though they are lower quality and may not last as long using an o-ring made from Buna on the bolt may be beneficial in cold temperatures. It is not recommended to use a Buna o-ring anywhere else in place of Urethane in the Vanquish bolt engine. Using Buna elsewhere may cause cycling issues.

Other Notes:

- It is OK to use either bolt that comes with your Vanquish marker. Neither performs better or worse in cold weather

ELECTRONIC BOARD FUNCTIONS

- Turn Marker ON - Press and hold the CENTER of the Directional Pad (the black button/joystick located under the screen) to turn board/marker ON - You are now in LIVE Mode (see below for more details) and the marker is ready to fire. The D-PAD joystick can be moved UP, DOWN, LEFT, RIGHT or pressed IN
- Turn Marker OFF - Press and hold CENTER on Directional Pad (D-pad) to enter the MAIN Menu, release D-Pad and then press CENTER on D-Pad when the display reads OFF to turn board off.
- Automatic Off feature - The Empire Vanquish also has an automatic off feature. If you accidentally leave your marker powered up, it will shut itself off after approximately 10 minutes of inactivity.



Note: The Auto Off time is adjustable in the SYSTEM Menu

Boot Up Splash Screen: When the marker is turned on the screen will display the boot up splash screen graphics for 3 seconds (Note - the boot screen display time can be changed via the settings menu, see page 15). After the boot screen time expires the marker is in LIVE mode and ready to fire. You may exit the boot screen and skip to LIVE mode at any time by moving the joystick in any direction or by pressing the trigger.

Note: The boot screen graphics can be changed using the Vanquish Boot Screen Editor and the Vanquish USB Tool on your PC. These applications come with your Vanquish Marker on the disc with the manual.

FIRMWARE VERSION: The firmware version will display at the bottom of the standard boot screen. If using a custom boot screen, software version will not display.

LIVE MODE

LIVE Mode is the standard mode when firing the marker. The main display will show the current Firing Mode, the current Rate of Fire (ROF) setting, Battery Level, Tournament Lock Status, Trigger Status, EYE Status, Game Timer, user preferred marker data (default is Pressure Reading).

Live Mode D-Pad Controls:

- Firing Mode - The upper section of the display shows the current Firing Mode. The Vanquish offers eight different Fire Mode options.
- Below the Firing Mode is the current Rate of Fire Cap setting, which can be changed in the CONFIG Menu (see below for more details). This number will change depending on whether the Eyes are On or Off.
- Battery Level Indicator - On the upper left of the display, below the Rate of Fire, is the Battery Level indicator. The indicator will blink when the battery is fully depleted.
- Tournament Lock - Below the Rate of Fire is the Tournament Lock indicator, shaped like a padlock. The Tournament Lock is engaged when the padlock icon is closed. The Tournament Lock can only be set by pressing a button on the Vanquish board (see page 16 for more details).
- Trigger Status - The display will show the status of the trigger- a down arrow indicates that the trigger is depressed.
- Eyes Status - Eyes are electronic light beams that will not allow the marker to fire until a paintball is completely loaded into the breech and “seen”. This feature helps eliminate chopped paintballs. Press D-Pad in the UP direction to toggle Eyes ON or OFF. The display icon will show one of four settings: Eye Off, Eye On-No Ball, Eye On with Ball, and Eye Malfunction
- Game Timer - On the bottom left, the display shows the Game Timer. Press the D-Pad in the DOWN direction to start the Game Timer. Press DOWN and hold for 1 second to stop the timer or hold DOWN for 3 seconds to reset the Game Timer.
- Press and Hold the D-Pad in the LEFT or RIGHT directions to display more user data.
- Regulator Pressure - The Vanquish Marker has a built in temperature compensated

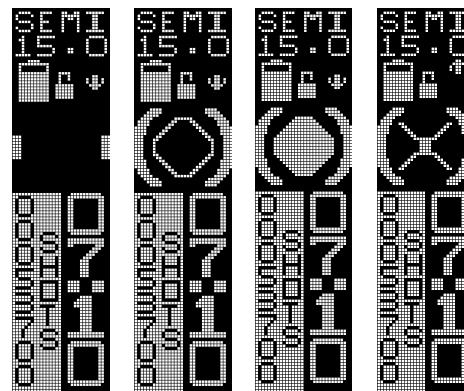

precision electronic pressure transducer. This shows the marker pressure as regulated by the ASA/Regulator.

The pressure transducer has a range of 50-250psi. Out of this range, pressure will not be displayed, and will display LOW or OVER.

- Shot Counter - The marker will keep track of the number of shots fired. This number will increase each time the solenoid is cycled and will be saved even when power is disconnected. Shot Counter can be reset in the settings menu.
- AVG and Peak ROF's Achieved - The Average ROF is the highest actual number of shots that were started within 1 second. The Peak ROF is the shortest time between 2 consecutive shots. This can be reset by pressing the center on the joystick 2 times quickly (Like double clicking a mouse).
- Lube Gauge - The Lube Gauge will monitor how many shots have occurred since last time the maker was lubricated. This gauge must be reset by the user when the marker is lubed for an accurate reading. There is also an alert associated with the Lube Gauge (see page 15 for Lube Alert).
- MAIN Menu - Press and hold CENTER on D-pad to enter the MAIN Menu (see below for more details).

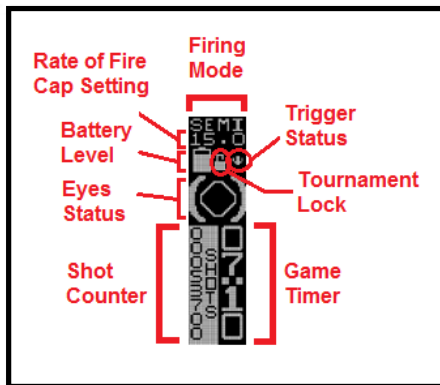

MAIN MENU

The display will show "MAIN MENU" at the top of the screen indicating the Main Menu. Press the D-pad to the RIGHT, LEFT, UP or DOWN directions to scroll through the MAIN Menu options. Press CENTER on the D-pad to make a selection.

- OFF - Turns Marker Off
- CONFIG - Enters User CONFIGurations Menu (see below)
- SYSTEM - Enters SYSTEM Settings Menu (see below)
- EXIT - Exits back to LIVE Mode

Note: MENU QUICK EXIT - As long as you are not currently modifying a setting, you can exit any menu at any time by pressing and releasing the trigger. This will take you back to LIVE Mode.

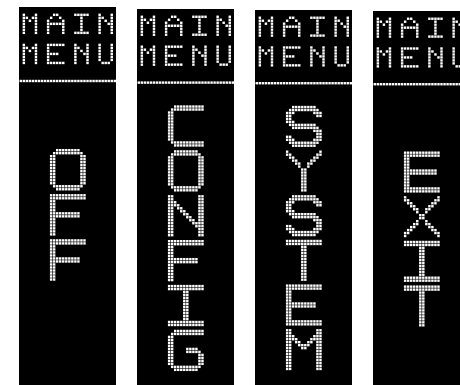

CONFIG MENU:

Note: Settings under this menu affect the markers firing characteristics and may not be modified when tournament lock is on. Press the D-pad in the UP or DOWN directions to scroll through the USER CONFIGURATIONS Menu options. Press CENTER or RIGHT on the D-pad enter the selected option and see the current setting.

User Configurations

There are 3 fully customizable user configurations (or profiles). The current user CONFIG NUM (Profile) is displayed on the screen (1, 2, or 3).

- Only the settings under CONFIG menu are linked to a specific User Profile.
- If Tournament Lock is active, the marker will beep when trying to make a selection and you cannot modify any settings in the CONFIG menu.
- Changing the values of a setting will only affect the Profile that is currently chosen.

If the current Profile is 1, any changes to the user settings in the CONFIG menu will only affect Profile 1.

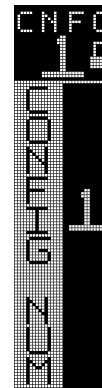

FIRE MODE - Choose between the different firing modes

- The current Firing Mode setting is displayed on the right side of the screen.
- Press CENTER or RIGHT to change the Fire Mode setting
- Press UP or DOWN to cycle through Firing Modes
- Press CENTER or LEFT to save your selection
- SEMI - Semi automatic firing shoots 1 shot per trigger pull up to the max ROF (Rate of Fire) setting
- RAMP - Semi auto shots (equal to Ramp Shot Start setting), then a Ramping rate of fire up to the max ROF setting (if Ramp Sustain Trigger Pulls per Second is achieved, see below)
- BURST - Semi auto shots (equal to Ramp Shot Start setting), then multiple-shot bursts at the max ROF. The number of shots in the burst is adjustable in the BURST SHOT setting. If time between shots is longer than Ramp Reset setting the marker goes back to Semi Automatic and the Ramp Start shot counter is reset.
- AUTO - Semi auto shots (equal to Ramp Shot Start setting), then Fully Automatic firing at the ROF CAP setting. If time between shots is longer than the Ramp Reset setting the marker goes back to Semi Automatic and the Ramp Start shot counter is reset.
- PSP BST 12 - Complies to 2010-2012 PSP rules using Burst mode as described above
- PSP RMP 12 - Complies to 2010-2012 PSP rules using Ramp mode as described above
- PSP BST 10 - Complies to 2014 PSP Champions/Challengers rules using Burst mode as described above
- PSP RMP 10 - Complies to 2014 PSP Champions/Challengers rules using Ramp mode as described above
- MILL - Complies to 2010-2012 Millennium Series Rules using Ramp mode as described above
- NPPL - Complies with 2012 NPPL rules using Semi Auto mode as described above

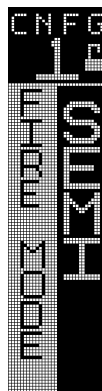

ROF CAP - Choose between having the marker Rate of Fire Capped or Uncapped. Turning this setting ON will cap the marker at the ROF (•) ON setting. Turning this setting OFF will uncapped the marker and allow the marker to fire as fast as paintballs can be loaded and detected by the eyes.

Note - Firing modes other than Semi may not be uncapped due to ASTM Safety Regulations.

- The screen displays the current setting of whether ROF CAP is On or OFF
- Press CENTER or RIGHT to change the ROF Cap setting
- Press UP or DOWN to cycle through ON or OFF
- Press LEFT or Press CENTER on D-Pad to save the setting and return to CONFIG menu

ROF (•) ON - The maximum Rate of Fire with Eyes On (ROF Cap must be ON)

- The screen displays the current ROF EYES ON setting
- Press RIGHT or Press CENTER on D-Pad to change the ROF with EYES ON setting
- Press UP or DOWN to increase/decrease the BPS setting (8.0-25.0 BPS, in 0.1 BPS increments)
- Press LEFT or Press CENTER on D-Pad to save setting and return to CONFIG menu



ROF (•) OFF - The maximum Rate of Fire with Eyes OFF

- The screen displays the current ROF EYES OFF setting
- Press RIGHT or Press CENTER on D-Pad to change the ROF with EYES OFF setting
- Press UP or DOWN to increase/decrease the BPS setting (8.0-25.0 BPS, in 0.1 BPS increments)
- Press LEFT or Press CENTER of D-Pad to save setting and return to CONFIG menu



ROF Default - The maximum allowed Rate of Fire if the eyes become dirty or malfunction.

- The screen displays the current ROF Default setting (in BPS)
- Press RIGHT or Press CENTER on D-Pad to change the ROF Default setting (default is 8 BPS)
- Press UP or DOWN to increase/decrease the BPS setting (7-12 BPS, in 1 BPS increments)
- Press LEFT or Press CENTER of D-Pad to save setting and return to CONFIG menu

Dwell - Is the amount of time the solenoid stays on to fire a ball. Setting the Dwell too high will decrease efficiency. Setting the Dwell too low will cause inconsistent velocity.

- The screen displays the current Dwell time (in milliseconds)
- Press RIGHT or Press CENTER of D-Pad to change the Dwell Time (Default is 12.0 ms)
- Press UP or DOWN to increase/decrease the Dwell setting (2.0-25.0 ms)
- Press LEFT or Press CENTER of D-Pad to save setting and return to CONFIG menu

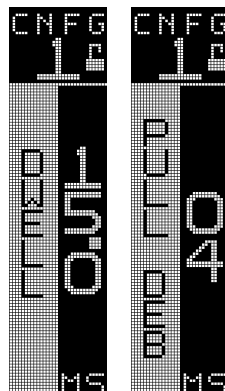

Pull Debounce (PULL DEB) - Time in milliseconds the trigger pull must be held to register a valid trigger pull. This eliminates electronic noise and vibrations that the board may wrongly interpret as a trigger action (trigger pull) and fire the marker. Too low of a value will cause undesired trigger pulls. Too high of a value will make it harder to achieve high rates of fire.

- The screen displays the current Trigger Pull Debounce setting (in milliseconds)
- Press RIGHT or Press CENTER of D-Pad to change the Trigger Pull Debounce setting (default is 4ms)
- Press UP or DOWN to increase/decrease the Pull Debounce setting (1-20 ms)
- Press LEFT or Press CENTER of D-Pad to save setting and return to CONFIG menu

Release Debounce (REL DEB) - Time in milliseconds the trigger must remain released before next pull can be registered. Too low of a value will cause undesired trigger pulls. Too high of a value will make it harder to achieve high rates of fire.

- The screen displays the current Trigger Release Debounce setting (in milliseconds)
- Press RIGHT or Press CENTER of D-Pad to change the Release Debounce setting (default is 6ms)
- Press UP or DOWN to increase/decrease the Release Debounce setting (1-20 ms)
- Press LEFT or Press CENTER of D-Pad to save setting and return to CONFIG menu

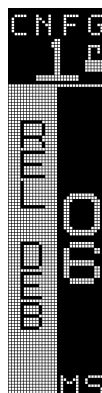

AMB Level - Anti-Mechanical Bounce will help prevent "Run Away" during sustained firing which is described as the marker shooting extra shots when the user is not pulling the trigger. A lower value will make it easier to maintain high rates of fire. A higher value will prevent "Run Away."

- The screen displays the current AMB Level (adjustable from level 0-10 with level 0 being off)
- Press RIGHT or Press CENTER of D-Pad to change the AMB Level (default is 0)
- Press UP or DOWN to increase/decrease the AMB LEVEL setting (1-10)
- Press LEFT or Press CENTER of D-Pad to save setting and return to CONFIG menu

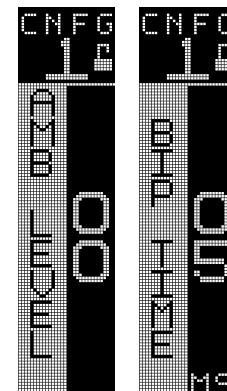

Ball in Place (BIP) Time - Consecutive milliseconds the Eyes must sense a ball before they will allow the marker to fire. Increase this setting for slower feeding loaders to avoid chopping balls in the breach. Decrease this setting for use with faster feeding loaders to increase max ROF. This setting only has an affect when the eyes are on and not malfunctioning. If not using a force feed loader a setting of at least 10ms is recommended.

- The screen displays the current BIP Time (in milliseconds)
- Press RIGHT or Press CENTER of D-Pad to change the Ball In Place setting (default is 5ms)
- Press UP or DOWN to increase/decrease the BIP setting (1-20 ms)
- Press LEFT or Press CENTER of D-Pad to save setting and return to CONFIG menu

Anti-Bolt Stick (ABS) Wait Time - The time in seconds that must expire after a shot before ABS is activated. This helps prevent first shot drop-off. ABS is a feature to compensate for stiction of the bolt which causes low velocity on first shots of a string.

- The screen displays the current ABS Wait Time (in seconds)
- Press RIGHT or Press CENTER of D-Pad to change the ABS Wait setting (default is 30s)
- Press UP or DOWN to increase/decrease the ABS Wait setting (10-200 sec, in 10 second increments)
- Press LEFT or Press CENTER of D-Pad to save setting and return to CONFIG menu



Anti-Bolt Stick (ABS) Dwell - Time that the dwell is increased by for the first shot when ABS is activated. Too high of a setting may cause first shot of a string to have high velocity. Too low of a setting may cause excessive bolt stick or first shot drop off.

- The screen displays the current ABS Dwell Time (in milliseconds)
- Press RIGHT or Press CENTER of D-Pad to change the ABS DWELL setting (default is 10.0ms)
- Press UP or DOWN to increase/decrease the ABS Dwell setting (0-50 ms)
- Press LEFT or Press CENTER of D-Pad to save setting and return to CONFIG menu

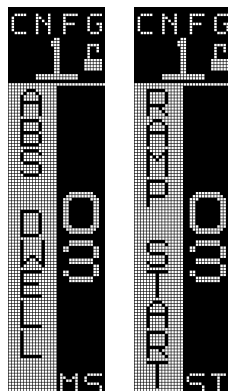

Ramp Start - Number of Semi-Auto shots needed before selected firing mode kicks in (affects all firing modes but Semi-Auto and NPPL).

- The screen displays the current Ramp Start setting (in # of shots)
- Press RIGHT or Press CENTER of D-Pad to change the Ramp Start setting (default is 3 shots)
- Press UP or DOWN to increase/decrease the Ramp Start setting (3-12 shots)
- Press LEFT or Press CENTER of D-Pad to save setting and return to CONFIG menu

Ramp Sustain - Trigger Pulls per Second (TPS) that must be maintained to continue ramping (affects RAMP, PSPR and MILL modes).

- The screen displays the current Ramp Sustain setting (in trigger pulls per second)
- Press RIGHT or Press CENTER of D-Pad to see current Ramp Sustain setting (default is 3)
- Press UP or DOWN to increase/decrease the Ramp Sustain setting (3-12 TPS)
- Press LEFT or Press CENTER of D-Pad to save setting and return to CONFIG menu

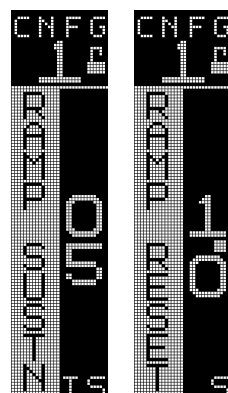

Ramp Reset - Time after the last trigger pull before Ramp Start Shot count will reset (affects all modes except Semi and NPPL).

- The screen displays the current Ramp Reset (in seconds)
- Press RIGHT or Press CENTER of D-Pad to change the Ramp Reset setting (default is 1.0)

- Press UP or DOWN to increase/decrease the Ramp Reset setting (0-1.0 sec in 0.1s increments)
- Press LEFT or Press CENTER of D-Pad to save setting and return to CONFIG menu

Burst Shots - Determines how many shots are fired at each trigger pull when marker firing mode is BURST or PSP B. This setting will only affect BURST and PSP B firing modes.

- The screen displays the current Burst Shots setting (in # of shots)
- Press RIGHT or Press CENTER of D-Pad to change the Burst Shots setting (default is 3 shots)
- Press UP or DOWN to increase/decrease the Burst Shot setting (2-6 shots)
- Press LEFT or Press CENTER of D-Pad to save setting and return to CONFIG menu
Back - Return to MAIN Menu
- Press RIGHT or Press CENTER of D-Pad when BACK is visible to return to the MAIN Menu.

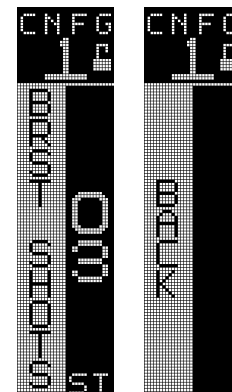

SYSTEM MENU

Settings under this menu affect secondary functions of the marker that do not have to do with firing characteristics.

Navigating the System Menu

- Press the D-pad in the UP or DOWN directions to scroll through the SYSTEM Menu options. The current setting for each option will be displayed on the right side of screen.
- To select a setting for modification press the D-Pad RIGHT or CENTER.
- Tilt the D-Pad UP or DOWN to modify the setting value.
- Tilt the D-Pad LEFT or press CENTER to save the setting and go back to the System Menu.



Game Timer - Set the Game Timer countdown duration.

- The screen displays the current Game Timer duration - MM = Minutes, SS = Seconds (MM:SS)
- Press the D-Pad Right or Center to change the duration time (default 7:10)
- Press UP or DOWN to increase/decrease the

Game Timer minutes (00-99)

- Press CENTER of D-Pad to save minutes setting
- Press UP or DOWN to increase/decrease the

Game Timer seconds (00-59)

- Press CENTER of D-Pad to save seconds setting
- Press LEFT or Press CENTER of D-Pad to save settings and return to SYSTEM Menu

Timer Alarm - An audible alarm sounds with 1 minute left and continuously after the timer has expired.

- Press RIGHT or Press CENTER of D-Pad to change the setting from On or OFF
- Press UP or DOWN to cycle through ON or OFF (default is ON)
- Press LEFT or Press CENTER of D-Pad to save the setting and return to SYSTEM Menu

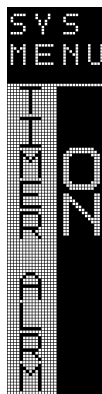

Trigger CMD - After holding the trigger for 1 second while the marker is Live, Trigger Command allows the marker to perform a function, either Force Shot, or Toggle the Eyes On or Off, or both. A Force Shot is when the marker will cycle once with the Eyes ON even though there is no ball in the breach. This is to allow sound activated loaders to begin loading. The Trigger Command may also be set to OFF which will not perform any function when the trigger is held for 1 second.

- The screen displays the current setting of the Trigger Command
- Press RIGHT or Press CENTER of D-Pad to change the Trigger Command (either OFF, TOGGLE, FORCE or BOTH)
- Press UP or DOWN to cycle through ON or OFF (default is BOTH)
- Press LEFT or Press CENTER of D-Pad to save setting and return to SYSTEM menu

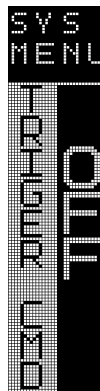

Dwell Lock - When selected ON, changing the Dwell Setting in any of the 3 user configurations (C1, C2, C3) will change the dwell for all 3 configurations. When OFF, the dwell in each user configuration can be changed independently.

- The screen displays the current setting of either ON or OFF
- Press RIGHT or Press CENTER of D-Pad to change the Dwell Lock setting (default is ON)

- Press UP or DOWN to cycle through ON or OFF
- Press LEFT or Press CENTER of D-Pad to save the setting and return to SYSTEM Menu

Brightness - Adjustable the brightness of the screen display when screen is not dimmed

- The screen displays the current setting of the Brightness setting (A numerical value of 10%-100%, where 100% is the brightest setting)
- Press RIGHT or Press CENTER of D-Pad to change the Brightness setting (default is 50%)
- Press UP or DOWN to increase/decrease the Brightness setting (10-100)
- Press LEFT or Press CENTER of D-Pad to save the setting and return to SYSTEM Menu

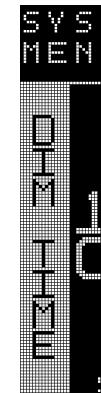

Dim Time - The elapsed time after the last joystick activation in which the screen will dim to save power.

- The screen displays the current Dim Time setting (in seconds)
- Press RIGHT or Press CENTER of D-Pad to change the Dim Time setting (default is 10 sec)
- Press UP or DOWN to increase/decrease the setting (5-60 sec, in 5 sec intervals)
- Press LEFT or Press CENTER of D-Pad to save setting and return to SYSTEM menu

Auto Off - The elapsed time after the last trigger activation in which marker will shut off to save power.

- The screen displays the current Auto Off setting (in minutes)
- Press RIGHT or Press CENTER of D-Pad to change the Auto Off time (default is 10 min)
- Press UP or DOWN to increase/decrease the Auto Off setting (5-60min, in 5 minute intervals)
- Press LEFT or Press CENTER of D-Pad to save setting and return to SYSTEM menu

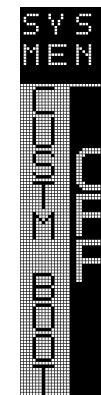

Custom Boot - This setting allows the user to turn the use of the custom boot screen graphics on/off. Custom boot screens can be made and downloaded using the Vanquish Boot Screen Editor and the Vanquish USB Tool software. These applications are included with the Vanquish on disc

manual.

Note - if a custom boot screen has not been downloaded but the user turns it on the default boot screen will display. The firmware version will not display when the custom boot screen is turned on.

- The screen displays whether the Custom Boot setting is On or Off
- Press RIGHT or Press CENTER of D-Pad to change the Custom Boot setting (default is OFF)
- Press UP or DOWN to switch the setting to either ON or OFF
- Press LEFT or Press CENTER of D-Pad to save setting and return to SYSTEM menu

Boot Time - This setting changes the amount of time the boot up splash screen is displayed when the marker is turned on. This time is adjustable from 0-5seconds with a setting of 0 not displaying the splash screen at all. This setting applies to both the standard and custom boot screens.

- The screen displays the current Boot Time setting (in seconds)
- Press RIGHT or Press CENTER of D-Pad to change the Boot Time setting (default is 3 sec)
- Press UP or DOWN to increase/decrease the setting (0-5 sec)
- Press LEFT or Press CENTER of D-Pad to save setting and return to SYSTEM menu

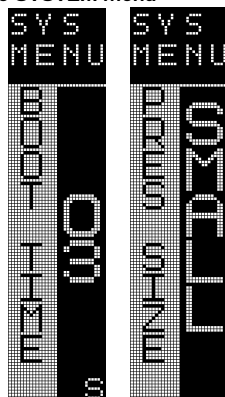

PRES SIZE - There are two font size options for displaying the Regulator Pressure - Large or Small.

- The screen displays whether the PRES SIZE setting is Large or Small
- Press RIGHT or Press CENTER of D-Pad to change the Pres Size setting (default is Small)
- Press UP or DOWN to switch the setting to either SMALL or LARGE
- Press LEFT or Press CENTER of D-Pad to save setting and return to SYSTEM menu

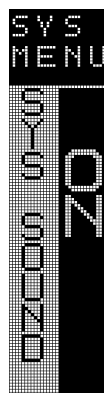

System (SYS) Sound - Turns the system sounds ON or OFF, including the startup, shutdown, and enter/exit menu sounds.

- The screen displays the current setting of either ON or OFF
- Press RIGHT or Press CENTER of D-Pad to change the System Sound (default is ON)
- Press UP or DOWN to cycle through ON or OFF

- Press LEFT or Press CENTER of D-Pad to save setting and return to SYSTEM Menu

JSTK Sounds - Joystick Sounds: Enables a beep when the joystick is activated when setting is ON.

- The screen displays the current setting of either ON or OFF
- Press RIGHT or Press CENTER of D-Pad to change the Joystick Sound setting (default is ON)
- Press UP or DOWN to cycle through ON or OFF
- Press LEFT or Press CENTER of D-Pad to save setting and return to SYSTEM Menu

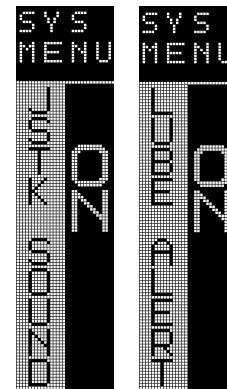

Lube Alert - This setting turns the Slick Assistant lube alerts ON or OFF. The Slick Assistant lubrication monitoring system will alert the user if it is time to re-lube the marker. This alert plays a sound and shows a special alert message on screen when the marker is turned on. It also plays a sound if the Slick Assistant Lube Gauge is displayed during live mode.

- The screen displays the current setting of either ON or OFF
- Press RIGHT or Press CENTER of D-Pad to change the Lube Alert setting (default is ON)
- Press UP or DOWN to cycle through ON or OFF
- Press LEFT or Press CENTER of D-Pad to save setting and return to SYSTEM Menu

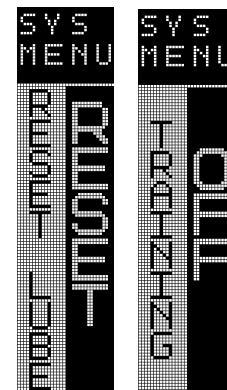

Reset Lube - This setting will reset the lube gauge. This should be reset each time the marker is lubed. Two choices reset or cancel

Training - When training mode is ON, while in Live Mode, instead of the marker cycling the solenoid, it will chirp quickly. The eyes are bypassed. This is for users to practice trigger activation without the need for an air source. Note - the marker will not fire while training mode is on.

- Press RIGHT or Press CENTER of D-Pad to see if Training Mode setting is On or OFF
- Press UP or DOWN to cycle through ON or OFF (default is OFF)
- Press LEFT or Press CENTER of D-Pad to save setting and return to SYSTEM Menu

RST Shots - Reset Shot Counter: Resets the Shot Counter when YES is selected (also available through LIVE Mode menu)

- Press RIGHT or Press CENTER of D-Pad to Reset Shot Counter
- Press LEFT or Press CENTER of D-Pad to reset the counter, then return to SYSTEM Menu

FCTRY RST - Factory Reset: Resets all settings to factory defaults when YES is selected

- Press RIGHT or Press CENTER of D-Pad for FACTORY RESET
- Press UP or DOWN to cycle from NO to YES
- Press LEFT or Press CENTER of D-Pad to activate RESET if YES is set
- Screen will then display “Resetting” and then will shut down

BACK - Selecting will return you to the MAIN Menu

- Press RIGHT or Press CENTER of D-Pad to return the MAIN Menu

TOURNAMENT LOCK

Tournament lock is a feature that prevents the marker from entering the Settings Mode while in the field, to allow the marker to be tournament legal. See your tournament’s rule book for an explanation on what is required to lock your marker. Tournament Lock can be turned on/off by using the dip switch located on the Main circuit board. See page 26 for instructions on accessing the Main circuit board. Flip the dip switch to the ON position to activate the Tournament Lock. When Tournament lock is ON, Settings Mode cannot be activated.

SOFTWARE VERSION

- On startup, the software version will display next to the logo.
- Hold CENTER on D-Pad during startup to continuously display the logo and software version.

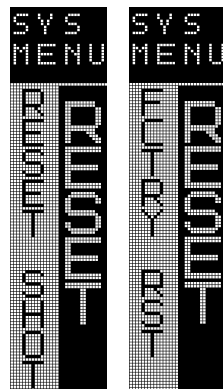



VANQUISH MENU TREE

OFF	Turns Vanquish Off	
CONFIG	User Profile	
	Firing Mode	1,2,3 - 3 fully customizable user configurations - only settings under config menu are linked to a config
	Semi	Semi automatic firing up to max ROF setting
	Ramp	Semi to Ramp Start Shots then step up to ROF Cap setting if ramp sustain TPS is achieved
	Burst	Semi to Ramp Start Shots then fires at ROF Cap setting for Burst Shot amount
	Full Auto	Semi to Ramp Start Shots then Fully Automatic at ROF Cap setting
	PSP BST 12	Compliant with PSP 2010-2012 rules using Burst mode described above
	PSP RMP 12	Compliant with PSP 2010-2012 rules using Ramp mode described above
	PSP BST 10	Compliant with 2014 PSP Professional Division rules using Burst mode described above
	PSP RMP 10	Compliant with 2014 PSP Professional Division rules using Ramp mode described above
	MIL 10	Compliant with 2010-12 Millennium Series rules using Ramp mode as described above
	NPPL	Compliant with 2012 NPPL Rules using Semi auto mode as described above
	ROF CAP	
	ROF EYES ON	ON/OFF Toggle On/Off for ROF Cap with eyes on
	ROF EYES ON	8.0-25.0 BPS Max Rate of Fire with eyes on (ROF Cap must be on)
	ROF DEFAULT	8.0-25.0 BPS Max Rate of Fire with eyes off
	DWELL	7-12 BPS Max Rate of Fire when eyes malfunction (also known as an eye default)
	PULL DEB	2.0-25.0 ms Dwell; solenoid on time in milliseconds
	REL DEB	1-20ms Trigger Pull De-bounce; time in ms trigger pull must be held to be valid
	AMB LEVEL	1-20ms Trigger Release De-bounce; time in ms trigger must remain released before next pull can be activated
	BIP TIME	0-10 Helps prevent bounce during rapid fire.
	ABS WAIT	1-20ms Ball In Place time; time in ms ball must stay in breech before it can be fired
	DWELL	10-60s Anti-Bolt Stick Wait Time; time that must expire after a shot before ABS is activated
	ABS DWELL	2.0-25.0 ms Dwell; solenoid on time in milliseconds
	RAMP START	0-50ms Anti-Bolt Stick Dwell; time in ms that will be added to dwell after ABS Wait time to prevent bolt stick
	BURST SHOTS	3-12 shots Ramp Start; number of semi-auto shots before ramping kicks in (affects all firing modes but semi-auto)
	RAMP SUSTN	2-6 shots Amount of shots per pull, used when in burst mode
	RAMP RESET	3-12TPS Ramp Sustain; trigger pulls per second that must be maintained to ramp (only used in RAMP and Mil 10 modes)
		0.0 to 1.0s Ramp Reset; time in seconds after last trigger pull in which ramping will stay active
	BACK - Back to Main Menu	

VANQUISH MENU TREE

SYSTEM	GAME TIMER	
	TIMER ALARM	00:00 - 99:59 Game Countdown Timer; MM:SS -> MM = Minutes, SS = Seconds
	TRIGGER CMD	On/Off Game Timer Alarm; audible alarm sounds when game time expires if on.
	DWELL LOCK	None, Force, Toggle Trigger Command; Function for trigger being held for 1second. None=No Function, Force=Force Shot, Toggle=Toggle Eyes
	BRIGHTNESS	On/Off Dwell Lock; When on all 3 user profiles will have the same dwell setting. When off each profile may have a different Dwell value
	DIM TIME	10-100 Screen Brightness; Adjusts brightness of screen when not dimmed
	AUTO OFF	5-30s Dim Time; time after last joystick activation in which screen will be dimmed
	BOOT SCREEN	5-30min Auto Off; time after last trigger activation in which marker will be shut off
	PRESSURE SIZE	On/Off Custom Boot Screen; Turns on user designed custom boot screen
	SYS SOUND	Small/Large Regulator Pressure Display Text Size; Changes size of text of regulator pressure display
	JSTK SOUNDS	On/Off System Sounds; turns system sounds on/off incl. startup, shutdown, enter/exit menu sounds
	LUBE ALERT	On/Off Joystick Sounds; turns beep when joystick is activated on or off
	TRAINING	On/Off Slick Assistant Lube Alert, Turns alert screen on boot up and alert sounds on or off
	BOOT SCREEN	On/Off Training Mode; when on eyes are bypassed, solenoid does not cycle, marker chirps when fired
	FCTRY RST	On/Off Custom Boot Screen; Turns on user designed custom boot screen
	RAMP RESET	Reset/Cancel Factory Reset; resets all settings to factory defaults
	0.0 to 1.0s Ramp Reset; time in seconds after last trigger pull in which ramping will stay active	
<i>BACK - Back to Main Menu</i>		



Vanquish PC SOFTWARE

The Vanquish PC Software consists of two separate applications, the Vanquish USB Tool which allows communication between the PC and Vanquish, and the Vanquish Boot Screen Editor which allows users to create custom boot screens that can be downloaded onto the Vanquish via the Vanquish USB Tool.

PC Requirements:

- Windows Vista, XP or 7 Operating System
- Hardware requirements
- 900 Mhz or faster processor
- Min. 128 MB RAM
- 25 MB of available hard disk space

Software Installation

Step 1 - Vanquish PC Software Installation

1. Insert the CD into your PC or download the files from www.PaintballSolutions.com
2. View the contents of the software files and double-click on "VPC Setup.exe" and follow the onscreen instructions for software installation to your PC.

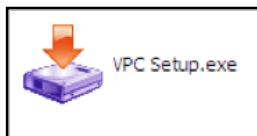

Note: Do NOT open the Vanquish PC software until instructed below!

Step 2 -

Ensure marker is Safe by removing the gas source and all paintballs before proceeding with USB connection. With the Vanquish turned OFF, remove the firing engine and loosen the front grip screw of the Vanquish Marker to access the USB port (see page 26). Connect your Vanquish to your PC via the USB cable that came with the marker.

Note: The battery must be connected to the Vanquish for the USB connection to work.

Step 3 - Installing USB Drivers

Access the USB port on the Vanquish Marker Circuit board and connect the board to your computer via USB cable. If you have an active internet connection, proceed to Step (A). If not proceed to Step (B).



A. If you have an active internet connection the drivers will automatically install. Simply allow windows to install the drivers for you and wait for the installation to complete. Note- windows may install several drivers. If windows does not automatically install proceed to (B) below.

B. To manually install the FTDI USB/COM/Serial drivers please proceed below to the area that matches the Windows version you use:

Windows XP Manual Install:

1. After connecting the Vanquish to the USB port, the New Hardware Found Wizard should appear.
2. Select the option "No, not this time" and click "Next" to continue.
3. Select "Install from a list or specific location (Advanced)" and click "Next".
4. Under "Search for the best driver in these locations" Browse to the "USB Drivers" folder in the Vanquish PC Software Folder then click "Next".
5. Depending on how your system is configured windows may pop up a warning. Click "Continue Anyway".
6. Windows will then proceed to install the first set of drivers. Click "Finish" after complete.
7. After this the New Hardware Found Wizard should appear again to install the second set of



drivers. Proceed as before with steps 2-5 to install.

Windows Vista Manual Install:

1. After connecting the Vanquish to the USB port the New Hardware Found window will appear.
2. Select "Locate and install driver software (recommended)".
3. When windows asks for the disk select "I don't have the disc, Show me other options".
4. Windows will say it could not find driver software. Click "Browse my computer for driver software".
5. Browse to the USB Driver Folder in the Vanquish PC Software Folder. Windows should install the first driver.
6. After installing the first driver the New Hardware Found Window should pop up again to install the second driver. Repeat steps 2-5 to install the second driver.

Windows 7 Manual Install:

1. With Vanquish connected to USB Port go to Start > Control Panel.
2. Select "Hardware and Sound".
3. At the next screen select "Device Manager" under "Devices and Printers".
4. In the Device Manager window under "Other Devices" there should be a device with a name similar to "FT232..." with a yellow warning symbol next to it, indicating the driver is not installed. Right-click this to bring up a small menu.
5. Select "Update Driver Software".
6. Next select "Browse my computer for driver software".
7. Browse to the USB Driver folder in the Vanquish PC Software Folder. This should install "USB Serial Converter" which is the first driver.
8. To install the second driver repeat steps 4-6. This should install USB Serial Port.

Finish Installation

Open the Vanquish USB Tool application (Vanquish USB Tool.exe) and the Vanquish Marker should automatically connect to the USB Tool. The status bar in the bottom of the window will indicate that the Vanquish has been connected.

Using the Vanquish USB Tool Software

The Vanquish USB tool allows users to complete the following tasks: edit and sync settings with the Vanquish, save settings to the PC, download custom boot screens onto the Vanquish, and update the Vanquish software.

1. Assure all paintballs and the gas source is removed from marker and marker has been safely discharged before connecting marker to your PC.
2. Remove bolt system and remove front grip frame screw to expose mini USB port on under side of the main circuit board (see page 26).
3. Connect USB cable between marker and PC.
4. Open the Vanquish USB Tool program and the marker will automatically connect to the Vanquish USB Tool.
5. If the Vanquish USB Tool software program is already open, press Connect.

ONCE CONNECTED:

Once the Vanquish is successfully connected to your PC, the User Configurations and System Settings will be loaded from the Vanquish board and automatically shown in the Vanquish USB Tool.

Users have the ability to:

- Change settings and load them to the marker
- Load settings from a file on the PC and load them onto the marker
- Save currently displayed settings onto the PC
- Flash new software onto the Vanquish
- Load Custom Boot Up Screens onto the Vanquish

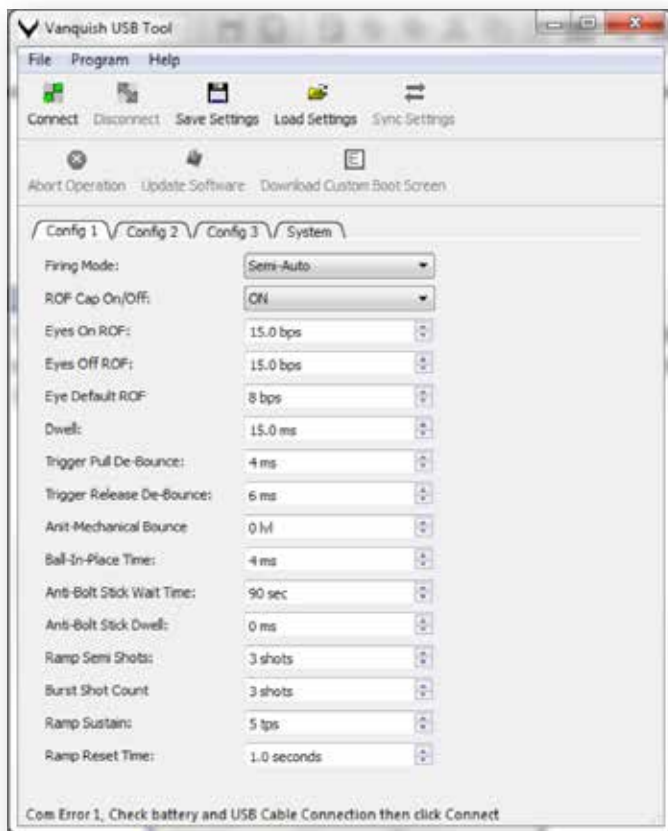

How to Sync Settings with Vanquish Marker

Click “Sync Settings” to sync the setting on the Tool software with the connected Vanquish marker. The settings must be synced before the changed settings appear on the Vanquish marker. The Status bar and pop-up messages will notify users when the sync is complete. Syncing the settings usually takes around five seconds.



How to Save Settings to PC

Click Save Settings and follow the prompt to save the current settings from the Vanquish USB Tool. Configuration 1, 2, 3 and System settings will be saved on the PC. The file format is .txt so it may be edited outside of the Vanquish USB Tool.

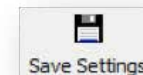

How to Load Settings from PC

Click “Load Settings” and follow the prompt to open and load a Vanquish settings file into the Vanquish USB Tool software. Click “Sync Settings” to sync the loaded settings with the Vanquish. Settings files are in .txt format, so they can also be edited outside of the Vanquish USB Tool.

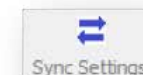

How to Update the Vanquish Board Software

Clicking “Update Software” will open a prompt that allows the user to select a Vanquish Firmware File (.vff). When the file is selected the software will be downloaded onto the Vanquish. The Status Bar and popup messages will notify users when the update is complete. This process typically takes between 30-45 seconds.

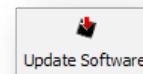

How to Download Custom Boot Screens to Vanquish

Click “Download Custom Boot Screen” and follow the prompt to choose a Vanquish Boot Screen File (.vbs) from the PC. Vanquish Boot Screen files are created with the Vanquish Boot Screen Editor (see below). When the file is selected the custom boot screen will be downloaded onto the Vanquish. The Status Bar and popup messages will notify users when the download is complete. The download typically takes about 5 seconds.

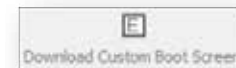

To Disconnect the Vanquish from the PC

Select PROGRAM->DISCONNECT to stop communication between marker and PC.



Vanquish Boot Screen Editor Software

The Vanquish Boot Screen Editor allows you to make your own custom graphics that can be loaded onto your Vanquish Paintball marker using the Vanquish USB Tool software. These graphics can be displayed when you turn on the Vanquish to make your Vanquish unique to you.

The Vanquish Screen is 128 pixels high by 32 pixels wide. The Boot screen editor gives you access to each individual pixel. A white pixel in the editor shows how the pixel will be illuminated on the Vanquish screen. A black pixel signals the pixel will not be illuminated.

Using the Vanquish Boot Screen Editor

- Pixels that are turned On are White. Left click a pixel with the mouse to turn it On.
- Pixels that are turned Off are Black. Right click a pixel with the mouse to turn it Off.

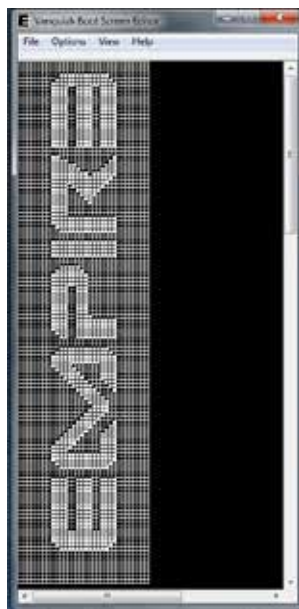

Saving Boot Screens

Click File>Save to save the custom boot screen. The graphics created in the Vanquish Boot Screen Editor are saved in a Vanquish Boot Screen file (extension .vbs). Only .vbs files can be downloaded onto the Vanquish Marker. You must save the boot screen before it can be downloaded onto the Vanquish Marker. To download a custom boot screen onto the Vanquish Marker see Download Custom Boot Screens to Vanquish (see above).

Other Controls

- Click File > Open to load a previously saved Vanquish Boot Screen file.
- The overall size of the editor window can be expanded by dragging the corner of the window.
- Zoom In by using the Options menu, View > Zoom In.
- Show normal size by selecting, View > Normal Size.
- Clear screen (all pixels black) by selecting Options > Clear Screen.
- Fill screen (all pixels white) by selecting Options > Fill Screen.

- Invert screen by selecting Options > Invert Screen. This turns white pixels to black and black pixels to white.

Vanquish PC Software Troubleshooting

Vanquish USB Tool will not Connect to Vanquish

- In the Vanquish USB Tool press Disconnect. Then attempt to connect by pressing Connect.
- On the Vanquish, disconnect the USB cable and disconnect the battery. Then re-connect the battery and then the USB cable in that order. Click Connect to attempt to connect again.
- Restart Vanquish USB Tool
- With the USB cable and battery connected to the Vanquish, in the Vanquish USB Tool, go to Program > USB Tool Options to open the settings menu. Under “Com Port” select the Com port named “USB Serial Port” (see picture below). If this choice is not available, the USB drivers have not been installed. See the section above for instructions to install the USB Drivers.

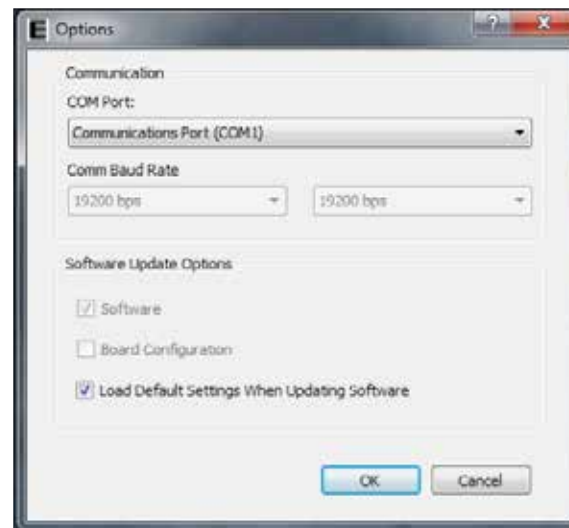



The Status Bar Says “Com Error 1...” or “Com Error 2...”

- On the Vanquish, disconnect the USB Port and disconnect the battery. Then re-connect battery and then the USB Cable in that order. Click Connect to attempt the connection again.

The Status Bar Says “Flash Error 1...” or “Flash Error 2...”

- On the Vanquish, disconnect the USB Port and disconnect the battery. Then re-connect battery and then the USB Cable in that order. Click Connect to attempt the connection again.

Cannot run/open Vanquish USB Tool or Vanquish Boot Screen Editor

The required Microsoft files may not be installed on your computer. These files can be installed by running the installers located in the Vanquish PC Software directory, (Typically C:\Documents and Settings*Windows User Name*\Vanquish PC Software\MsVcRd). Select the 32bit version for 32 bit Windows systems or 64bit version for 64bit Windows systems.

- If you are not sure of whether your Operating System is 32bit or 64bit, this information can be found in the Control Panel under the Start menu. Once in the Control Panel, click on System - the OS version will be displayed in the System screen.

Still having trouble? Contact paintballsolutions.com to speak with tech support personnel.

GENERAL MAINTENANCE

CAUTION: Before attempting to perform any maintenance operations, make sure that all paintballs and air sources have been removed from the marker and that the regulator pressure reads LOW psi. Install a barrel-blocking device, and ensure the Vanquish power is OFF.

Keep your Empire Vanquish clean and lubricated to eliminate the friction that would prevent reliable operation. It is recommended that you clean and lube the marker before each use.

Do not use oil or petroleum-based lubricants in the lubrication of this marker. Teflon or silicon (non-spray only) lubricants designed for use on O-Rings may be used for lubrication for the Firing Engine. Dow 33, the included factory lubricant or a lube specifically engineered for paintball markers is highly recommended.

Disassembly Tips

- Make sure you have a clean area to work on your marker, so you don't lose or misplace parts.
- After reassembling the Empire Vanquish recheck your trigger activation settings.
- Visit PaintballSolutions.com for additional information.

External Cleaning

Use a clean cloth, dampened with water to clean the outside of the Empire Vanquish. Do not use any chemicals or cleaners, as you may damage the protective finish.

Warning: Do not rinse the Empire Vanquish under water, as you may damage the marker's electronics.

Barrel

It is recommended that all sections of that the barrel be removed before any maintenance or disassembly is performed. Simply turn the full barrel counter-clockwise to remove. Use warm water and a barrel cleaning device to keep the barrel in top condition. Dry thoroughly.

Firing Engine Assembly

Removal of Firing Engine

Before you remove the Firing Engine, make sure you remove the air cylinder from the marker and that the pressure reads LOW psi.

- Push and hold in the Back Cap Release Button at the rear of the marker while the marker is facing in a safe direction
- While holding the button in, pull the Back Cap backwards until the Firing Engine is free of the Body.

Maintenance of Firing Engine

Firing Engine maintenance should be performed approximately every 10,000 - 20,000 shots.

1. Remove the Bolt Tip from the bolt by squeezing the rubber tip and pulling it off.

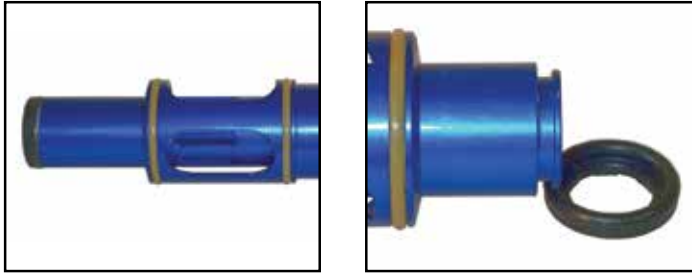

2. Unscrew the Air Guide by turning the Air Guide counter-clockwise to remove the Back Cap.



3. Push the Bolt out of the back of the Air Guide.



4. Unscrew the Bolt Guide from the Back Cap. Remove old grease and debris from Firing Engine.



5. Wipe the parts down with a clean rag removing any old grease or debris.
6. Inspect the O-Rings on both the bolt and Air Guide for any wear or damage. Replace damaged or worn O-Rings if necessary.
7. Lubricate the inner O-Ring on the Back Cap (#5 from O-Ring Diagram).



8. Apply grease to #6 Bolt O-ring and apply a light coat of grease to entire bolt.



9. Apply grease to the two small O-Rings on the Rod #8a, #8b.

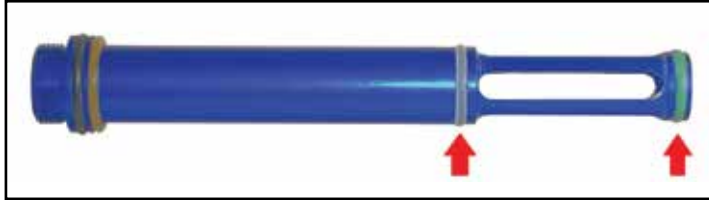

10. Lubricate the 3 inner O-Rings on the Air Guide (#2a, #2b, #2c), no lube is needed on the outer O-Rings.

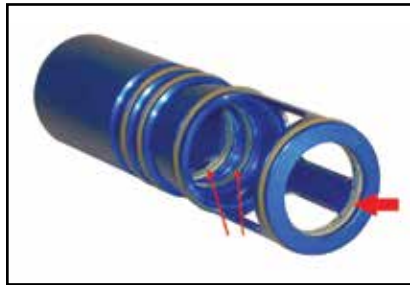

11. Apply a light coat of grease on the inner surface of the Air Guide, where the Bolt O-Rings make contact.



12. Reassemble the Firing Engine in the reverse order of Step 3 thru 1.

Firing Engine O-Ring Guide

1	V16 AIR GUIDE (72987) (QTY 1)	8	O-RING 012/70A URETHANE (11710) (QTY 1)
2	O-RING 020/70A URETHANE (72560) (QTY 5)	9	O-RING 013/70A URETHANE (11827) (QTY 1)
3	O-RING 017/70A URETHANE (72538) (QTY 4)	10	V16 ROD (72985) (QTY 1)
4	RUBBER BOLT TIP (72659) (QTY 1)	11	O-RING 014/70A URETHANE (72553) (QTY 1)
5	V16 BOLT W/TIP + O-RINGS (72986) (QTY 1)	12	O-RING 015/90A URETHANE (41010) (QTY 1)
6	O-RING 015/90A BUNA (72549) (QTY 1)	13	O-RING 019/70A URETHANE (11710) (QTY 1)
7	O-RING 016/70A URETHANE (76042) (QTY 1)	14	V2.0 BOLT GUIDE (DUST BLK) (72862) (QTY 1)

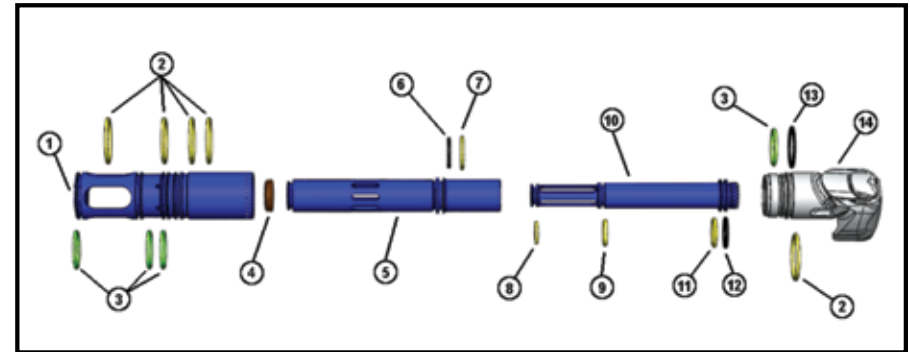

Cleaning the Eyes / Ball Detents

The eyes should be cleaned thoroughly after a ball break. Leaving paint on the eyes for an extended amount of time may cause damage to the electrical contacts. Remove the eye cover to access the eye board. Use a cotton swab to remove paint or debris in the body and off of the eye board. Ensure that the path in front of the eyes is clear and reinstall the eye boards and eye covers.

The Eyes should be cleaned thoroughly after a ball break in the breech. Leaving paint on the Eyes for an extended amount of time can damage the electrical contacts and cause a malfunction.

- Remove the Eye Cover using the 3/32" Hex wrench to access the Eye Board



- Carefully remove the Eye Board from the body
- Use a Q-tip to remove any paint or debris from the Eye Board and the Eye cavity of the Body
- Ensure that the opening in front of the Eyes is clear and that the laser has a clear path to the opposite Eye.
- Inspect the Ball Detents, faulty or worn out Ball Detents can cause double feeding or ball breaks
- Clean or replace as necessary
- Re-install the Eye Board and Eye Cover. Repeat process with the opposite Eye Boards if necessary

Regulator

Removal of Regulator

- Remove the two regulator mount screws located on the bottom of the grip frame with a 3/32" Allen wrench by turning them counter-clockwise.
- Make sure the O-Ring is on the bottom of the air tube; grease if necessary.
- Slide regulator back into the grip frame and tighten the regulator mount screws with a 3/32" Allen wrench.

Installation of Regulator Assembly

- Make sure the air transfer O-Ring is on the bottom of the grip frame; grease if necessary.
- Slide regulator back into the grip frame and tighten the regulator mount screws with a 3/32" Allen wrench.

Warning: Do not take the regulator apart; it is not designed to be user serviceable. Damage to the regulator will not be covered under warranty.

Splitting the Body

1. Remove the Firing Engine assembly from the Body (see pg 23)
2. Locate the screw that holds the Body to the Grip Frame, it is located at the front of the marker, within the Front Grip below where the Barrel meets the Body.
3. Using the 3/32" Hex wrench, completely loosen the screw holding the Body to the Grip Frame.
4. The Body can now be opened away from the Grip Frame hinging at the back of the marker.



5. Once open, you can access the Main Board and the USB port for PC connection.



Trigger Maintenance

The Trigger is removed from the Frame Insert using a single pin located on the side of the Grip Frame (see image below).

1. Split the body of the Vanquish Engine as explained earlier on page 26.
2. Using the 3/32" Hex wrench, remove the two screws to free the Frame Insert.
3. Unplug the Battery Harness from the Board
4. Use a hex wrench to push the pin out of the Frame Insert, which frees the Trigger
5. Once the Trigger is free, inspect for any paint or debris and clean with a cloth dampened with water.
6. The Spring Tension can be adjusted with the Trigger removed.
7. If necessary, clean the bearings to ensure a smooth trigger pull. The bearings can be lubricated with a drop or two of marker oil on the side housing.
8. To re-install, place the trigger back in the Frame Insert, secure with the Trigger Pin and place the Frame Insert into the Grip Frame and secure the screws with a 3/32" hex wrench.





TROUBLESHOOTING GUIDE

PROBLEM	SOLUTION
MARKER LEAKS	
There is a constant leak coming from under the body/trigger frame area	Clean and Lubricate the Firing Engine as described in this manual Check the Regulator pressure using the on screen read out and ensure the pressure is below 200psi. Check O-ring on outside of Air Guide, 4th from the front of the marker (Firing Engine Diagram #1d). Size -020 Urethane Check the O-ring on the outside of the Bolt nearest to the rear of the marker (Firing Engine Diagram #7) and replace if necessary. Size -016 Urethane Check the Air Transfer O-ring located on the underside of the Body just behind the main circuit board and replace if necessary. Size 1mm X 5mm Buna Remove the main circuit board and check the O-ring located on the Pressure Sensor (The silver cylinder located near the rear of the circuit board). Replace O-ring if necessary. Size -011 Buna Remove the Solenoid and check the 3 Solenoid O-rings located on the underside of the body. Replace if necessary. Size 1mm X 5mm Buna
There is a consistent leak in the breech or down the barrel of the marker	Check the O-ring on outside of Air Guide closest to the front of the marker (Firing Engine Diagram #1a) and replace if necessary. Size -020 Urethane Check the O-ring on the Rod, closest to the front of the marker (Firing Engine Diagram #8) and replace if necessary, Size -012 Urethane Check the O-ring on inside of Air Guide closest to front of marker (Firing Engine Diagram #2a) and replace if necessary. Size -017 Urethane
There is a constant leak from the exhaust holes on the back cap of the firing engine	Check the O-ring on the Rod nearest to rear of the marker where the Air Guide screws into the Back Cap (Firing Engine Diagram #10) and replace if necessary. Size -015 Buna Check the O-ring on the Rod, 2nd to the front of the marker (Firing Engine Diagram #9) and replace if necessary, Size -013 Urethane
There is a constant leak coming from between the bottom of the grip frame and the ASA/regulator	Check marker pressure using on screen pressure readout and keep it below 200psi Remove ASA/Regulator and check O-ring located between grip frame and ASA/Regulator. Replace is necessary. Size -008 Buna
ASA/REGULATOR ISSUES	
There is a leak coming from the bottom of the ASA/Regulator in the on/off lever area.	Replace O-ring around tank depression pin. Size -006 Buna
My ASA/regulator does not always instantly de-pressurize when I turn the lever off	Use 3-4 drops of paintball marker oil in the ASA/regulator where the tank is screwed in. Apply air to marker and cycle the marker to work the oil through.
<p style="text-align: center; color: green;">For more advanced regulator issues please contact paintballsolutions.com. Advanced regulator service is recommended only by certified persons.</p>	



TROUBLESHOOTING GUIDE

MARKER FIRING ISSUES	<i>Before trouble shooting ensure marker has been properly cleaned and lubricated and that a fresh, brand name Alkaline or Lithium 9V battery is being used</i>
My marker will not turn on when I press the power button	Change the battery in marker, If battery is new try unplugging battery from marker for at least 2 seconds and re-connecting battery.
	Ensure front grip frame screw is fully tightened to allow for full connection between main circuit board and front circuit board
My marker has low air efficiency/is not getting the expected amount of shot per air fill but there are no leaks	Note - If the marker is connected to you PC via USB the marker may not turn on.
	Check the paint size to the barrel size you are using. Using a smaller Super Freak insert to get a tighter fit will greatly increase efficiency
	Clean and lubricate the Firing Engine (see Maintenance section above)
	Check rubber bolt tip and replace if necessary
	Check the Dwell setting on the circuit board and decrease it if necessary.
	Check O-ring on outside of Air Guide 2nd from the front of the marker (Firing Engine Diagram #1b) and replace if necessary. Size -020 Urethane
	Check O-ring on inside of Air Guide 2nd from the front of the marker (Firing Engine Diagram #2b) and replace if necessary. Size -017 Urethane
My marker has inconsistent velocity or inconsistent cycles but there are no leaks	Check the paint size to the barrel size you are using. Using a smaller Super Freak insert to get a tighter fit will greatly increase consistency
	Clean and lubricate the Firing Engine (see Maintenance section above)
	Change battery in marker
	Check the Dwell setting on the circuit board and increase it if necessary. If you increase your Dwell you may have to lower the regulator pressure to achieve desired velocity
	Check the rubber bolt tip and replace if necessary
	Check the O-ring located on outside of the Bolt nearest to the rear of the marker (Firing Engine Diagram #7) and change if necessary. Size -016 Urethane
	Check the O-ring located on inside of the Air Guide 3rd from the front of the marker (Firing Engine Diagram #2c) and change if necessary. Size -017 Urethane
	Check the O-ring located in the threads on the outside of the Back Cap (Firing Engine Diagram #3) and replace if necessary. Size -019 Buna
Check the O-ring located in the inside of the Back Cap (Firing Engine Diagram #5) and replace if necessary. Size -017 Urethane	
My marker will not cycle and a puff of air escapes from the underside of the marker body when the trigger is pulled but there are no leaks	Clean and lubricate the Firing Engine (see Maintenance section above)
	Change battery in marker
	Check the Dwell setting on the circuit board and increase it if necessary.
	Check the O-ring located on outside of Air Guide 3rd from the front of the marker (Firing Engine Diagram #1c) and replace if necessary. Size -020 Urethane
	Check the O-ring located on inside of Air Guide 3rd from the front of the marker (Firing Engine Diagram #2c) and replace if necessary. Size -017 Urethane



TROUBLESHOOTING GUIDE

My marker will not cycle and a puff of air escapes from the underside of the marker body when the trigger is pulled but there are no leaks	Clean and lubricate the Firing Engine (see Maintenance section above)
	Change battery in marker
	Check the Dwell setting on the circuit board and increase it if necessary.
	Check the O-ring located on outside of Air Guide 3rd from the front of the marker (Firing Engine Diagram #1c) and replace if necessary. Size -020 Urethane
My marker will not cycle and a puff of air escapes from the rear of the Firing Engine when the trigger is pulled and there are no leaks	Check the O-ring located on inside of Air Guide 3rd from the front of the marker (Firing Engine Diagram #2c) and replace if necessary. Size -017 Urethane
	Clean and lubricate the Firing Engine (see Maintenance section above)
After my marker sits for a while the first shot has low velocity or does not fully cycle.	Change battery in marker
	Check the O-ring on outside of Back Cap (Firing Engine Diagram #4) and change if necessary. Size -020 Urethane
	Check the O-ring on inside of Back Cap (Firing Engine Diagram #5) and change if necessary. Size -017 Urethane
	This is known as Bolt Stick or First Shot Drop Off (FSDO)
My markers first shot has a higher velocity than the rest of the shots after my marker is not fired for a little while	Clean and lubricate the Firing Engine (see Maintenance section above)
	Change battery in marker
	Increase the Anti-Bolt Stick Dwell and possibly decrease the Anti-Bolt Stick Time settings on the circuit board to minimize this effect if it is not corrected from lubricating the firing engine
My markers velocity decreases during rapid fire	Check the Anti-Bolt Stick Dwell setting and decrease it or set it to 0 to turn it off completely
	Check the regulator pressure by using the on screen read out and watch to see if the pressure is increasing significantly. If the pressure rises consistently for more than 1 minute your regulator may need to be serviced. Contact PaintballSolutions.com
My marker is chopping paint in the breech	Clean and lubricate the Firing Engine (see Maintenance section above)
	Change battery in marker
	Apply 3-5 drops of paintball marker oil in the ASA/Regulator where the tank is screwed in. Apply air to the marker and cycle the marker 20-50 times to allow oil to work.
My marker is chopping paint in the breech	Check the regulator pressure during rapid fire by using the on screen read out. If the pressure is not recharging fully during rapid fire your regulator may need to be serviced. Contact PaintballSolutions.com
	Check and clean the eyes (See general maintenance section for directions on accessing eyes).
	Check rubber bolt tip and replace if necessary
	Check the ball detents in the breech. If either the ball detents or springs is broken or worn replace them.

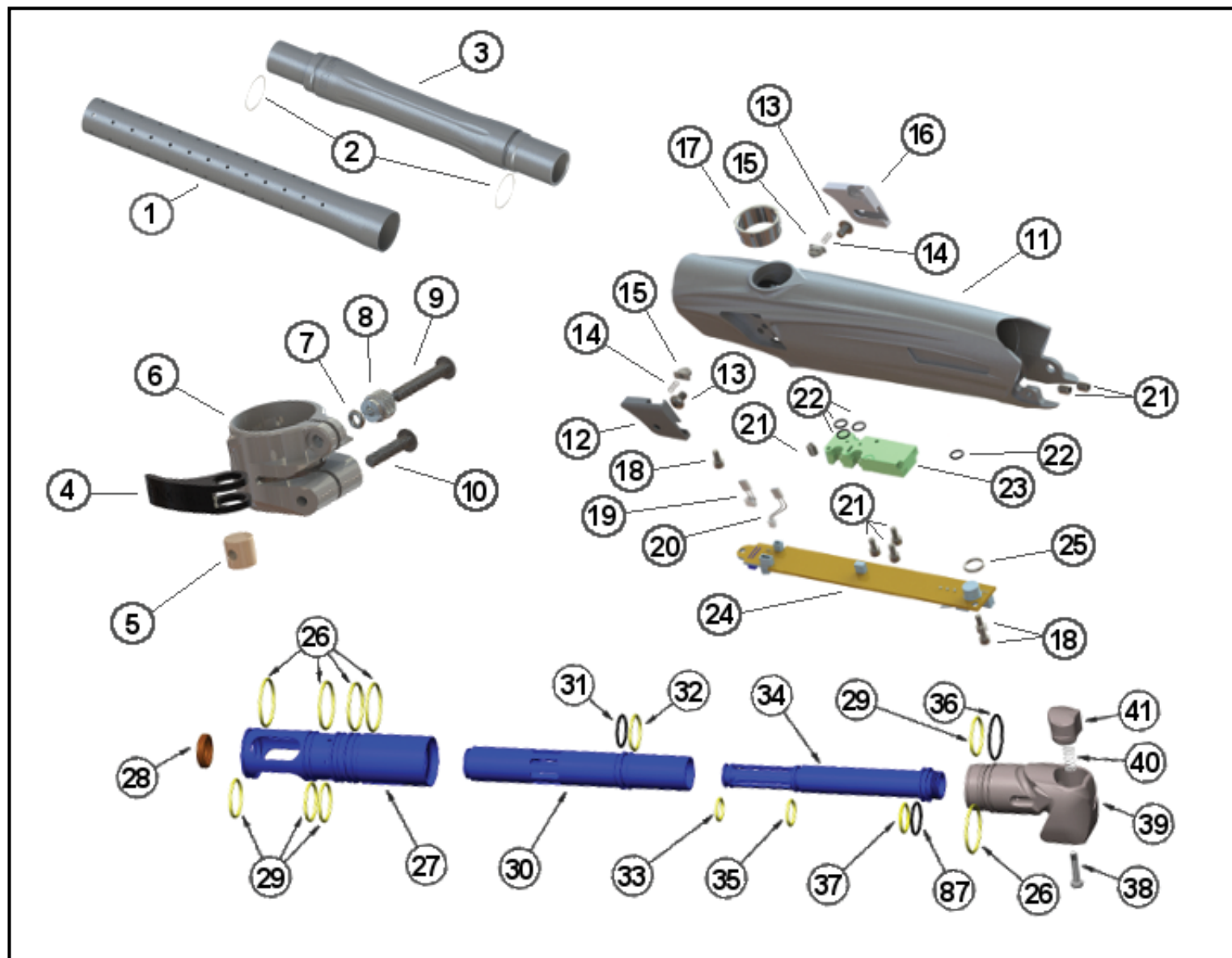

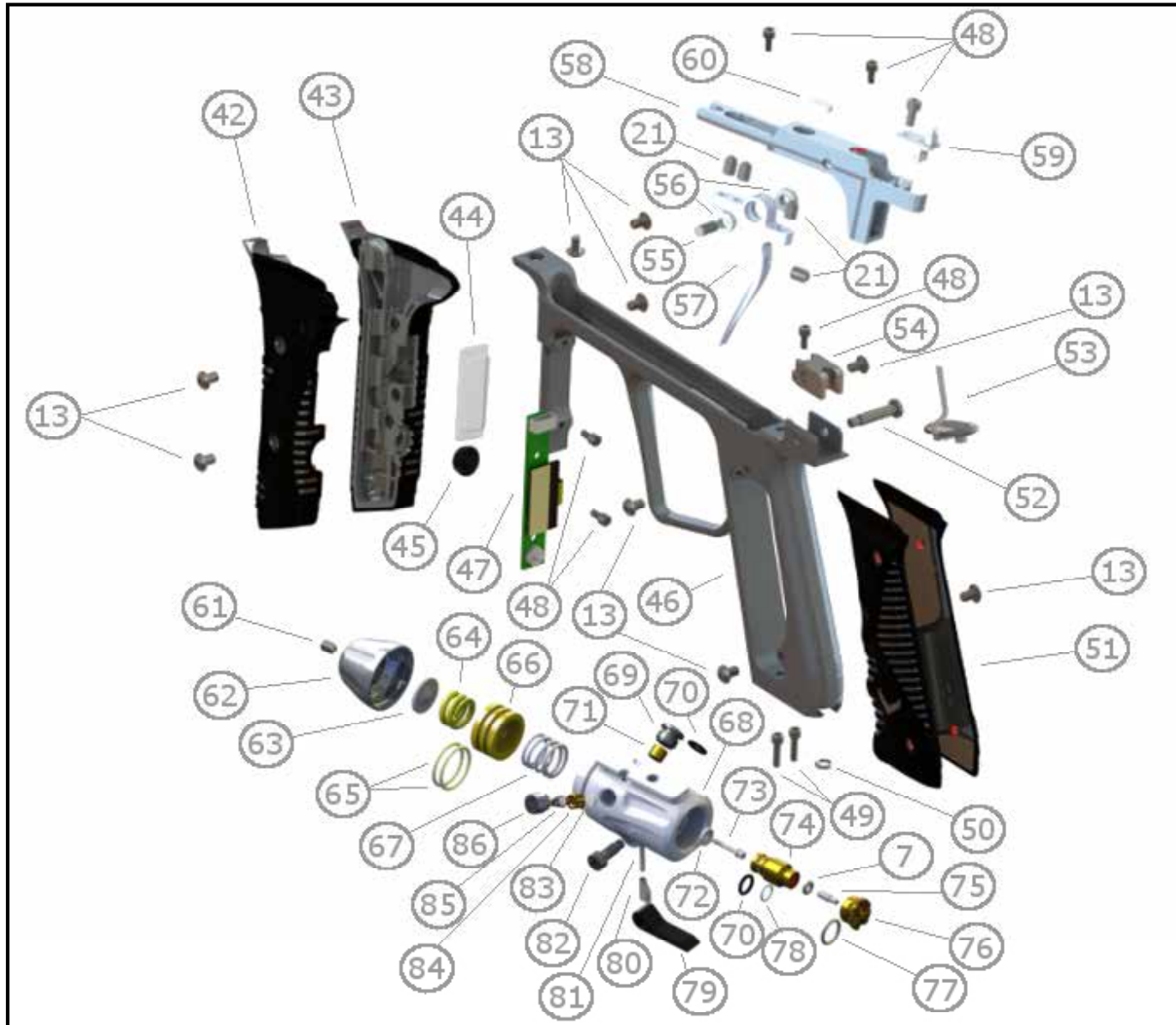



#	PART DESCRIPTION	SKU #
1	ALU Barrel Tip - Dust Black	72910
2	O-Ring BUNA-N 70 DUR 1mm CS X 19.5mm ID	72488
3a	Barrel Back .682 ID - Polished Black	72913
3b	Barrel Back .685 ID - Polished Black	72914
3c	Barrel Back .688 ID - Polished Black	72915
3d	Barrel Back .691 ID - Polished Black	72916
4	Feedneck Lever - Dust Black	72983
5	Feedneck Bushing	72573
6	Feedneck - Polished Black	72869
7	O-Ring BUNA-N 70 DUR -006 (.114 ID)	72489
8	Thumb Nut	72570
9	Screw BHCS 8-32 X 1.000	72497
10	Screw BHCS 8-32 X .750	72496
11	Body - Dust Black	72875
12	Eye Cover LH - Dust Black	72879
13	Screw BHCS 8-32 X .250	72515
14	Spring COM. 1090D X 0.250FL .010WD Rate 2.50lb/in	72656
15	Detent Delrin	72655
16	Eye Cover RH - Dust Black	72882
17	Feedneck Adapter - Black	72805
18	Screw SHCS 5-40 X .250	72517
19	Eye Board Harness LH	72886
20	Eye Board Harness RH	72887
21	Screw Set 10-32 X .250 CP	72500
22	O-Ring BUNA-N 70 DUR 1mm CS X 5mm ID	72559
23	Solenoid	72562
24	Main Circuit board	72885
25	O-Ring BUNA-N 70 DUR -011 (.301 ID)	11864
26	O-Ring URETHANE 70 DUR -020 (.864 ID)	72560
27	Air Guide V16	72987
28	Bolt Tip	72659

29	O-Ring URETHANE 70 DUR -017 (.676ID)	72536
30	Bolt V16	72986
31	O-Ring BUNA 90 DUR -015 (.551 ID)	72549
32	O-Ring URETHANE 70 DUR -016 (.614 ID)	76042
33	O-Ring URETHANE 70 DUR -012	11710
34	Rod V16	72985
35	O-Ring URETHANE 70 DUR -013 (.426 ID)	11827
36	O-Ring BUNA-N 70 DUR -019 (.801 ID)	72557
37	O-Ring URETHANE 70 DUR -014 (.489 ID)	72553
38	Bolt Release Button Screw	72867
39	Bolt Guide - Polished Black	72860
40	Bolt Release Button Spring	72868
41	Bolt Release Button - Dust Black	72864
42	Foregrip LH - Black/Grey	72618
43	Foregrip RH - Black/Grey	72619
44	Screen Cover	72617
45	OLED Button	72616
46	Grip Frame - Polished Black	72902
47	Daughter Circuit board	72620
48	Screw SHCS 5-40 X .250	72517
49	Screw SHCS 5-40 X .438	72516
50	O-Ring BUNA-N 70 DUR -008 (.176 ID)	72550
51	Main Grip - Black/Grey	72586
52	Rear Body Screw SS	72909
53	Battery Harness	72587
54	Locking Block	72908
55	Trigger Insert Dowel Pin	72907
56	Bearing .156 ID X .3125 OD X .1555	72888
57	Trigger - Dust Black	72893
58	Trigger Frame Insert - Polished Black	72889

59	Power Board	72906
60	Magnet 8mm DIA X 3mm	72576
61	Screw Set 10-32x.375 Cup Point	72654
62	Regulator Cap - Dust Black	72615
63	Regulator Disk	72609
64	Main Regulator Spring	72608
65	O-Ring BUNA-N 70 DUR -017 (.676 ID)	40916
66	Piston	72611
67	Piston Return Spring	72607
68	Regulator Body - Dust Black	72897
69	Regulator Filter Cap	72595
70	O-Ring BUNA-N 70 DUR 1.5mm CS X 6.5mm ID	72509
71	Regulator Filter	72596
72	Piston Washer	72364
73	Regulator Pin	72363
74	Regulator Seal Retainer	72652
75	On/Off Pin	72372
76	Regulator Nut	72599
77	O-Ring BUNA 70 DUR -012 (.364 ID)	72490
78	O-Ring BUNA-N 70 DUR 1mm CS X 6.0mm ID	72546
79	Regulator Lever	72613
80	Wedge Pin	72614
81	Wedge Pin Spring	72597
82	Screw SHSS 3/16 DIA 3/8 LG 8-32 X .250	72512
83	Regulator Rubber Seal	72605
84	Regulator Seal	72606
85	Regulator OPP Spring	72604
86	Regulator Cover Plate	72610
87	O-Ring URETHANE 90 DUR -015 (.551 ID)	41010
Not Shown	Vanquish Jewel LH - Black	72929
Not Shown	Vanquish Jewel RH - Black	72930



G.I. Sportz is dedicated to providing you with products of the highest quality and the industry's best product support available for satisfactory play.

G.I. Sportz
11723 Lime Kiln Rd.
Neosho, MO 64850
www.GISportz.com
G.I. Sportz Paintball is a brand of G.I. Sportz Direct, LLC.

PATENT(S): See www.paintballsolutions.com/patents © 2018 G.I. Sportz. All rights reserved. This G.I. Sportz product is protected by one or more United States patents. G.I. Sportz Trademarks, Designs and Copyrights are protected by one or more United States patents and International Law. For more information contact G.I. Sportz at info@GISportz.com

Warranty Registration

To activate the Limited Warranty, you must register the Loader within thirty (30) days of the date of original retail sale by completing the form found of the Paintball Solutions website: <http://www.paintballsolutions.com/index.php/warranty-registration/>

The Limited Warranty for G.I. Sportz Accessories does not require activation or registration; by registering the Loader, you activate the warranty for the Accessories.

Limited Warranty

G.I. Sportz warrants to the original purchaser that it will make any repairs or replacements necessary to correct defects in material or workmanship, at no charge to you, for the Product for a specific time period (as stated above) from the date of original retail sale. All G.I. Sportz asks is that you properly maintain and care for the Product and that you have warranty repairs performed by G.I. Sportz or a G.I. Sportz Certified Tech Center. This Warranty is non-transferable, and it does not cover damage or defects to the Product caused by (a) improper maintenance; (b) alteration or modification; (c) unauthorized repair; (d) accident; (e) abuse or misuse; (f) neglect or negligence; and/or (g) normal wear and tear. G.I. Sportz does not authorize any person or representative to assume or grant any other warranty obligation with the sale of this Product.

THIS IS THE ONLY EXPRESS WARRANTY GIVEN WITH THE PURCHASE OF THIS PRODUCT; ANY AND ALL OTHER EXPRESS WARRANTIES ARE DISCLAIMED. THE IMPLIED WARRANTIES OF MERCHANTABILITY AND FITNESS FOR A PARTICULAR PURPOSE ARE LIMITED TO THE APPLICABLE LIMITED WARRANTY PERIOD SET FORTH HEREIN, AND NO WARRANTIES, WHETHER EXPRESS OR IMPLIED, SHALL APPLY AFTER EXPIRATION OF SUCH PERIOD.

Some states and nations do not allow limitations on the duration of implied warranties, so the above limitation may not apply to you. The sole and exclusive liability of G.I. Sportz and/or its authorized dealers under this Limited Warranty shall be for the repair or replacement of any part or assembly determined to be defective in material or workmanship.



G.I. SPORTZ SHALL NOT BE LIABLE FOR, AND YOU EXPRESSLY DISCLAIM, ANY DIRECT, INDIRECT, CONSEQUENTIAL OR INCIDENTAL DAMAGES (COLLECTIVELY, "DAMAGES") ARISING OUT OF THE SALE OR USE OF, OR YOUR INABILITY TO USE, THE PRODUCT. NO PAYMENT OR OTHER COMPENSATION WILL BE MADE FOR DAMAGES, INCLUDING INJURY TO PERSON OR PROPERTY OR LOSS OF REVENUE WHICH MIGHT BE PAID, INCURRED OR SUSTAINED BY REASON OF THE FAILURE OF ANY PART OR ASSEMBLY OF THE PRODUCT.

Some states and nations do not allow the exclusion or limitation of incidental or consequential damages, so the above limitation or exclusion may not apply to you. This warranty gives you specific legal rights, and you may also have other rights that may vary from state to state or nation to nation.
Warranty and Non-Warranty Repairs

For Warranty parts, service, information or manuals in other languages, (where applicable) contact Paintball Solutions: www.paintballsolutions.com E-Mail: tech@paintballsolutions.com
US: 1-800-220-3222
11723 Lime Kiln Rd., Neosho, MO 64850

When shipping the Product to G.I. Sportz for warranty or non-warranty repair:

1. If you have aftermarket parts on your Product, please test the Product with original stock parts before returning the Product for service or repair.
2. Disconnect any gas and/or air cylinders attached to your product and if sending any air cylinders back please make sure the bottles are completely drained of any air in the cylinder.
3. Always unload and remove the paintballs from the Product.
4. Ship the Product to the G.I. Sportz address identified.
5. You must pre-pay postage and delivery charges, use a carrier that provides tracking information.
6. Provide the date of purchase for the Product.
7. Briefly describe the repair requested.
8. Include your name, return address and a telephone number where you can be reached during normal business hours, if possible.

G.I. Sportz makes every effort to complete its repair work within twenty-four (24) hours of receipt. G.I. Sportz will return the Product to you via regular ground UPS. If you wish to have it returned using a faster service, you can request NEXT DAY AIR UPS or SECOND DAY AIR UPS, but you will be charged for this service and must include your credit card number with the expiration date. Your credit card will be charged the difference in additional cost over regular ground shipping service.



EMPIREPAINTBALL.COM
11723 Lime Kiln Rd, Neosho, MO 64850
800-220-3222

Empire Paintball is a brand of G.I. SPORTZ, LLC.