

ETHIA

OPERATORS MANUAL

⚠ WARNING

ADHERE STRICTLY TO THESE AND ALL OTHER SAFETY INSTRUCTIONS AND GUIDELINES!

01. **PLEASE READ AND UNDERSTAND ALL INSTRUCTION MANUALS BEFORE USE.**
02. The Eclipse Etha is not a toy. **PAINTBALL SAFETY RULES MUST BE FOLLOWED AT ALL TIMES.**
03. Careless or improper use, including failure to follow instructions and warnings within this User Manual and attached to the Etha could cause death or serious injury.
04. Do not remove or deface any warnings attached to the Etha.
05. Paintball industry standard eye/face/ear and head protection designed specifically to stop paintballs and meeting ASTM standard F1776 (USA) or CE standard (Europe) must be worn by the user and any person within range. Proper protection must be worn during assembly, cleaning and maintenance.
06. Hearing protection should be worn.
07. Never shoot at a person who is not wearing proper protection.
08. Never look directly into the barrel of the marker. Accidental discharge into the eyes may cause permanent injury or death. Never look into the barrel or breech area of the Etha whilst the marker is switched on and able to fire.
09. Keep the Etha switched off until ready to shoot.
10. Treat every marker as if it is loaded and ready to fire.
11. The electronic on/off is the markers safety, always switch off the marker when not in use. Always fit a barrel-blocking device to the Etha when not in use.
12. Always remove all paintballs from the Etha when not in use on the field of play.
13. Never point the Etha at anything you do not intend to shoot.
14. Do not shoot at persons within close range.
15. Do not field strip or remove any parts while the marker is pressurised.
16. Do not pressurise the Etha without the bolt system correctly installed, as high-pressure gas will be emitted.
17. Do not fire the Etha without the bolt system correctly installed.
18. Never put your finger or any foreign objects into the paintball feed tube of the Etha.
19. Never allow pressurised gas to come into contact with any part of your body.
20. Always remove the first stage regulator and relieve all residual gas pressure from the Etha before disassembly.
21. Always remove the first stage regulator and relieve all residual gas pressure from the Etha for transport and storage.

⚠ WARNING

ADHERE STRICTLY TO THESE AND ALL OTHER SAFETY INSTRUCTIONS AND GUIDELINES!

22. Always follow guidelines given with your first stage regulator for safe transportation and storage.
23. Always store the Etha in a secure place. Persons under 18 years of age must have adult supervision when using or handling the Etha.
24. Observe all local and national laws, regulations and guidelines.
25. Use only professional paintball fields where codes of safety are strictly enforced.
26. Use compressed air/nitrogen only. **DO NOT** use any other compressed gas or pressurised liquid including CO₂.
27. Always follow instructions, warnings and guidelines given with any first stage regulator you use with the Etha.
28. Use 0.68 calibre paintballs only.
29. Always measure your marker's velocity before playing paintball, using a suitable chronograph.
30. Never shoot at velocities in excess of 300 feet (91.44 meters) per second, or at velocities greater than local or national laws allow.
31. Any installations, modifications or repairs should be carried out by a qualified individual at a licensed and insured paintball facility.



THIS USERS MANUAL IS IN ENGLISH.

It contains important safety guidelines and Instructions. Should you be unsure at any stage, or unable to understand the contents of this manual you must seek expert advice.



LE MODE D'EMPLOI EST EN ANGLAIS.

Il contient des instructions et mesures de sécurité importantes. En cas de doute, ou s'il vous est impossible de comprendre le contenu du mode d'emploi, demandez conseil à un expert.



ESTE MANUAL DE USUARIOS (OPERARIOS) USARIOS ESTÁ EN INGLÉS.

Contiene importantes normas de seguridad e instrucciones. Si no está seguro de algún punto o no entiende los contenidos de este manual debe consultar con un experto.



DIESE BEDIENUNGS - UND BENUTZERANLEITUNG IST IN ENGLISCH.

Sie enthält wichtige Sicherheitsrichtlinien und -bestimmungen. Sollten Sie sich in irgendeiner Weise unsicher sein, oder den Inhalte dies Heftes nicht verstehen, lassen Sie sich bitte von einen Experten beraten.

THIS USER MANUAL MUST ACCOMPANY THE PRODUCT IN THE EVENT OF RESALE OR NEW OWNERSHIP. SHOULD YOU BE UNSURE AT ANY STAGE YOU MUST SEEK EXPERT ADVICE (SEE SERVICE CENTRES PAGE 60).

6 INTRODUCTION

An introduction to Planet Eclipse and the Etha paintball marker.

- 6 > WELCOME TO PLANET ECLIPSE
 - > THE PLANET ECLIPSE ETHA PAINTBALL MARKER
- 7 > INCLUDED WITH THE ETHA MARKER
 - > MARKER SPECIFICATIONS

8 QUICK SETUP

Details on how to get up and running quickly with your Etha. This section is essential reading for everyone.

- 8 > SWITCHING ON THE ETHA
 - > SWITCHING OFF THE ETHA
 - > FIRING THE ETHA
 - > THE ETHA CIRCUIT BOARD
- 9 > USING THE BREAK BEAM SENSOR SYSTEM
- 10 > FACTORY SET-UP GUIDE
- 11 > REPLACING A 9V BATTERY

12 ORIENTATION

Names the component parts of the Etha Marker. This section is essential reading for everyone.

- 12 > THE ETHA PAINTBALL MARKER
- 13 > THE SHAFT4 BARREL
- 14 > THE SL3 INLINE REGULATOR
- 15 > THE BOLT SYSTEM
- 16 > THE SOLENOID ASSEMBLY
- 17 > THE ON/OFF PURGE SYSTEM (OOPS)
- 18 > THE ETHA NAVIGATION CONSOLE
- 19 > OPERATIONAL OVERVIEW

20 USING YOUR ETHA

Detailed information on how to use the Etha.

- 20 > SETTING UP YOUR ETHA
 - > INSTALLING A BARREL
 - > T-SLOT MOUNTING SYSTEM
- 21 > 90 DEGREE HOSE FITTING
 - > STRAIGHT HOSE FITTING
 - > MACROLINE HOISING

- 22 > INSTALLING A PRESET AIR SYSTEM
- 24 > ATTACHING A LOADER
- 25 > SETTING THE TRIGGER
- 26 > ADJUSTING THE VELOCITY
- 27 > UNLOADING THE ETHA
- 28 > STORAGE AND TRANSPORTATION
- 29 > THE TOURNAMENT LOCK

30 USER INTERFACE

In depth information on setting up the Etha.

- 30 > UNDERSTANDING THE BBSS OPERATION
 - > THE BATTERY LEVEL INDICATOR
- 31 > THE SET UP MODE
 - > MODIFYING A PARAMETER
 - > EXITING SET UP MODE
- 32 > SET UP PARAMETERS
 - > THE FIRING MODE PARAMETER
 - > THE MAXIMUM RATE OF FIRE PARAMETER WITH BBSS ON (CAPPED MODES)
 - > THE MAXIMUM RATE OF FIRE PARAMETER WITH BBSS OFF
- 33 > DWELL
 - > DEBOUNCE
 - > THE FACTORY RESET

34 MAINTENANCE

A guide to performing routine maintenance.

- 34 > THE BREAK BEAM SENSOR SYSTEM (BBSS)
- 36 > THE SL3 INLINE REGULATOR
- 38 > ADVANCED SL3 INLINE REGULATOR MAINTENANCE
- 39 > CLEANING THE BOLT SYSTEM
- 42 > ASSEMBLING THE BOLT SYSTEM
- 44 > REMOVING THE FRAME
- 45 > ATTACHING THE FRAME
- 46 > THE TRIGGER ASSEMBLY
- 48 > THE SOLENOID MANIFOLD
- 50 > THE ETHA SOLENOID VALVE
- 51 > THE ON/OFF PURGE SYSTEM (OOPS)

53 FAULT FINDING

Information on how to resolve any problems that might arise with your Etha.

56 PARTS LIST

Lists of components that make up the Etha.

60 SERVICE CENTRES

Information on the location of your nearest Etha Service Centre.

61 SPARES

Available upgrades / repair kits for your Etha.

62 INDEX

Etha Manual Index

WARRANTY CARD

Tear-out product registration card to be completed and returned. Alternatively register online at

www.planeteclipse.com

QUICK GUIDE

CONTENTS
INTRODUCTION
QUICK SET-UP
ORIENTATION
USING THE ETHA
USER INTERFACE
MAINTENANCE
FAULT FINDING
PARTS LIST
SPARES & ACCESSORIES
INDEX



WELCOME TO PLANET ECLIPSE

Over the last 20 years, Planet Eclipse and Paintball have changed and evolved beyond belief. From humble beginnings in a rundown store on Deansgate in the heart of Manchester city centre to a new purpose built facility in Manchester, England.

We at Planet Eclipse have stayed true to the core values that we have always fought hard to uphold. These values are more than just words, they are what we believe; as a company, employees and as players. We want the equipment that we produce to be the best that it can be and we will not compromise on quality or shy away from research or innovation.

No matter if you are playing in the woods, down at your local paintball site or if you are competing at the World Cup of Paintball for big money prizes, you should demand the very best for your money and that is what we aim to deliver, backed up with award winning customer service and support.

No matter who you are, a player from a championship winning pro team, or a recreational scenario team... we feel every loss and will celebrate your every victory... Get more!

Ledz (Director, Planet Eclipse Ltd)

THE PLANET ECLIPSE ETHA PAINTBALL MARKER

Making a paintball marker that has the core attributes of a Planet Eclipse product but at a price point that makes it affordable for a player on virtually any budget is a huge ask. We have always strived to ensure that the quality, feel, reliability and level of customer support that players come to expect from Planet Eclipse are present in every one of our products: and that is exactly what we expect you to find with the Eclipse Etha.

The Etha is not only constructed using the same high quality aluminium, stainless steel and composite materials that you will find used in the rest of the Eclipse range of paintball markers, but is also manufactured, assembled and tested using the exact same quality control principles and procedures that have been developed on Eclipse markers over the last 20 years.

We believe that compromise is just not acceptable when it comes to quality, reliability and testing. Be it a Rec level Eclipse marker such as the Etha or the very pinnacle of our product line; the SL marker series, there are some things that are priceless to us. These are just some of them.

INCLUDED WITH THE ETHA MARKER

- 1x 2-piece 14.5" Eclipse Barrel
- 1x Eclipse Tool Tube
- 1x Eclipse Barrel Sock
- 1x Manual with Warranty Card Insert
- 1x Tube of Eclipse Grease
- 1x 9V battery¹
- 1x Spares Baggy

MARKER SPECIFICATIONS

Length - 539.4mm

Width - 33.51mm

Height - 212.2mm

Weight - 930g/2.05lb (with Eclipse Shaft4 14.5" barrel)

Calibre - 0.68"

Barrel Threads - Cocker

Barrel Type & Length - Eclipse Shaft4 - 14.5" two-piece

Fire Modes - Capped Semi-Automatic, Uncapped Semi-Automatic, PSP(2011) Compliant Ramping², Millennium(2010) Compliant Ramping².

Propellant - Compressed Air/Nitrogen

Body Material - 6000 Series Aluminium



Frame Material - Glass Reinforced Nylon

¹The 9V Battery is supplied already installed in the marker.



²Firing preset compliant at time of printing. Always check with event organiser for rule changes governing firing modes. Please note items included & marker specification of the Planet Eclipse Etha Marker may vary to what is printed above.

**PLEASE READ ALL THE WARNINGS
ON PAGES 2 & 3 BEFORE USING THIS
MARKER**

SWITCHING ON THE ETHA

At the rear of the frame is the *navigation console*. Press and hold the *select* button  (SEE FIGURE 1A). Release the *select* button  when the LED lights up and your Etha will begin its power up sequence.

SWITCHING OFF THE ETHA

Press and hold the *select* button . Release the *select* button  when the LED on the *navigation console* turns red. The LED will then extinguish and the Etha will turn off.



The Etha has a built in auto-off timer of 20 minutes. If the *trigger* is not pulled or the *select* button  is not pressed for 20 minutes then the Etha will power off.

FIRING THE ETHA

If the *Break Beam Sensor System* is enabled (the *BBSS* is automatically enabled on power up) and there is a paintball in the breech, pulling the *trigger* will fire the Etha. If the *Break Beam Sensor System (BBSS)* is disabled, the Etha will fire whenever the *trigger* is pulled, regardless of whether a paintball is in the breech or not.

The entire firing sequence is controlled electronically by the *Etha circuit board* and *solenoid valve*, enabling any user to achieve high rates of fire easily.

THE ETHA CIRCUIT BOARD

There are three sockets on the *Etha circuit board*, the *BBSS* connector , the *solenoid valve* connector  and the *micro-switch* connector .

There is a *tournament lock* button  towards the base of the board. Information on the *tournament lock* button functionality can be found on page 29. (SEE FIGURE 1B).



FIG 1A

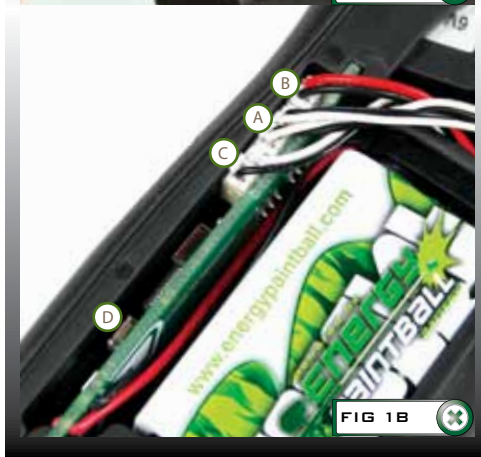



FIG 1B



USING THE BREAK BEAM SENSOR SYSTEM

The *Break Beam Sensor System*, referred to elsewhere in this manual as '*BBSS*' is used to detect when a paintball is ready to be fired from the Etha. If no paintball is ready then the *BBSS* will inhibit the Etha from firing. This prevents the Etha from "chopping" paintballs that are not fully loaded into the marker.

When the Etha is powered up, the *BBSS* is automatically enabled. The current state of the *BBSS* is displayed by a flashing LED on the *navigation console*.

To switch OFF the *Break Beam Sensor System*, push and hold the *select* button  for 0.5 seconds. The LED on the *navigation console* will flash purple indicating that the *Break Beam Sensor System* has been disabled.

To switch ON the *Break Beam Sensor System*, push and hold the *select* button  for 0.5 seconds. The LED on the *navigation console* will flash either yellow (no ball detected) or light blue (ball detected) indicating that the *Break Beam Sensor System* has been enabled.

Additional features of the Etha *Break Beam Sensor System* are covered in the 'Understanding the *BBSS* Operation' section on Page 30 of this User Manual.



QUICK GUIDE

CONTENTS
INTRODUCTION
QUICK SET-UP
ORIENTATION
USING THE ETHA
USER INTERFACE
MAINTENANCE
FAULT FINDING
PARTS LIST
SPARES & ACCESSORIES
INDEX

⚠ WARNING //////////////////////////////////////
DE-GAS YOUR MARKER, DISCHARGING ANY
STORED GAS IN A SAFE DIRECTION, AND REMOVE
THE BARREL, LOADER, AIR SYSTEM AND ANY
PAINTBALLS TO MAKE THE MARKER EASIER AND
SAFER TO WORK ON.

Before using the Etha it is important to make sure that the *inline regulator* and all electronically controlled parameters are set correctly, as some of these may have a negative (and potentially damaging) effect on the marker, in terms of performance and reliability, if incorrectly set.

The steps below will restore the Etha to the state that it left the factory.

-Reset the control parameters to the factory settings (see page 33).

-Check the *inline regulator adjuster screw* is set to $2^{1/2}$ turns clockwise from its maximum output (counter-clockwise) position (**SEE FIGURE 2A**). This will ensure the *inline regulator* is set to an output pressure that will not damage the Etha when supplied with compressed air/nitrogen (see page 26 for more information on the *inline regulator*).



FIG 2A



REPLACING THE 9V BATTERY

Ensure that the Etha is switched off. Place the marker on a flat surface in front of you with the *feed tube* furthest away from you and the barrel pointing to the right.

Using a 5/64" (2mm) hex key, remove the countersunk screw towards the bottom of the *frame* that holds the *grip panel* onto the *frame*. Lift the *grip panel* up to expose the electronics within the *frame*.

Remove the existing 9 volt battery by sliding your finger into the recess provided below the battery and gently lever the battery out of the *frame* (SEE FIGURE 3A).

On top of the battery you will see the *battery connector* that is used to connect the battery to the *circuit board*. Gently separate the *battery connector* from the battery, so that the existing battery can be disposed of responsibly, then taking a new 9 volt Alkaline battery (type PP3, 6LR61, MN1064)¹ connect it to the *battery connector* (SEE FIGURE 3B).

The battery will only connect to the *battery connector* one way. If you are unsure of how to install a new battery please contact your nearest Eclipse Service Centre.

Ensure that all of the wires are within the recess of the *frame* and not trapped in the *micro-switch* or *trigger spring*, then replace the *grip panel* and tighten the countersunk screw using the 5/64" (2mm) hex key.

DO NOT OVER-TIGHTEN THE GRIP SCREW.

¹Do not use rechargeable batteries or low quality batteries.

²Some brands 9V batteries may be too large for the Etha battery compartment in the grip frame. When installing a 9V battery, if it does not fit correctly, do not force the battery into place as the frame or battery connector may be damaged as a result.



FIG 3A



FIG 3B

QUICK GUIDE

CONTENTS

INTRODUCTION

QUICK SET-UP

ORIENTATION

USING THE ETHA

USER INTERFACE

MAINTENANCE

FAULT FINDING

PARTS LIST

SPARES & ACCESSORIES

INDEX

QUICK SET-UP

ETHA

THE ETHA PAINTBALL MARKER



- (A) BBSS COVER SCREW
- (B) BBSS COVER
- (C) SOLENOID ASSEMBLY
- (D) MANIFOLD ASSEMBLY
- (E) CIRCUIT BOARD
- (F) TRIGGER
- (G) MANIFOLD RETAINING SCREW
- (H) FRAME SCREW
- (I) GRIP SCREW

ORIENTATION

THE SHAFT4 BARREL

The Eclipse Etha comes as standard with an *Eclipse Shaft4 barrel*.^{1,4}

The *barrel* screws into the front of the Etha using a **right hand thread** meaning that if you hold the Etha pointing away from you the *barrel* screws into the *body* in a counter-clockwise direction.²

The *barrel* comprises of two parts, a *barrel back* (A) and a *barrel tip* (B). The two parts are joined together with a **left hand thread** meaning that if you hold the *barrel*, with the back section nearest you, the *barrel tip* screws in a **clockwise direction**.

On the *barrel back* there is a 016 NBR 70 o-ring (C) which prevents the *Shaft4 barrel* from vibrating loose from the *Etha body* when the marker is fired. There is also a 016 NBR 70 o-ring on the front of the *barrel back* (D) helps with alignment when the two barrel sections are screwed together.

Replace and lubricate these o-rings with Eclipse Grease as necessary.



¹The bore size of your Shaft4 may vary according to the model of Etha that you have.

²The Etha will only accept COCKER threaded barrels. Do not use any other type of barrel thread.

³The Eclipse Shaft4 tip and back barrel sections are not interchangeable with older version Shaft tip and back barrel sections (including Shaft3 barrel kits).

⁴The model of barrel accompanying your Etha may differ from that stated in this manual.

THE SL3 INLINE REGULATOR

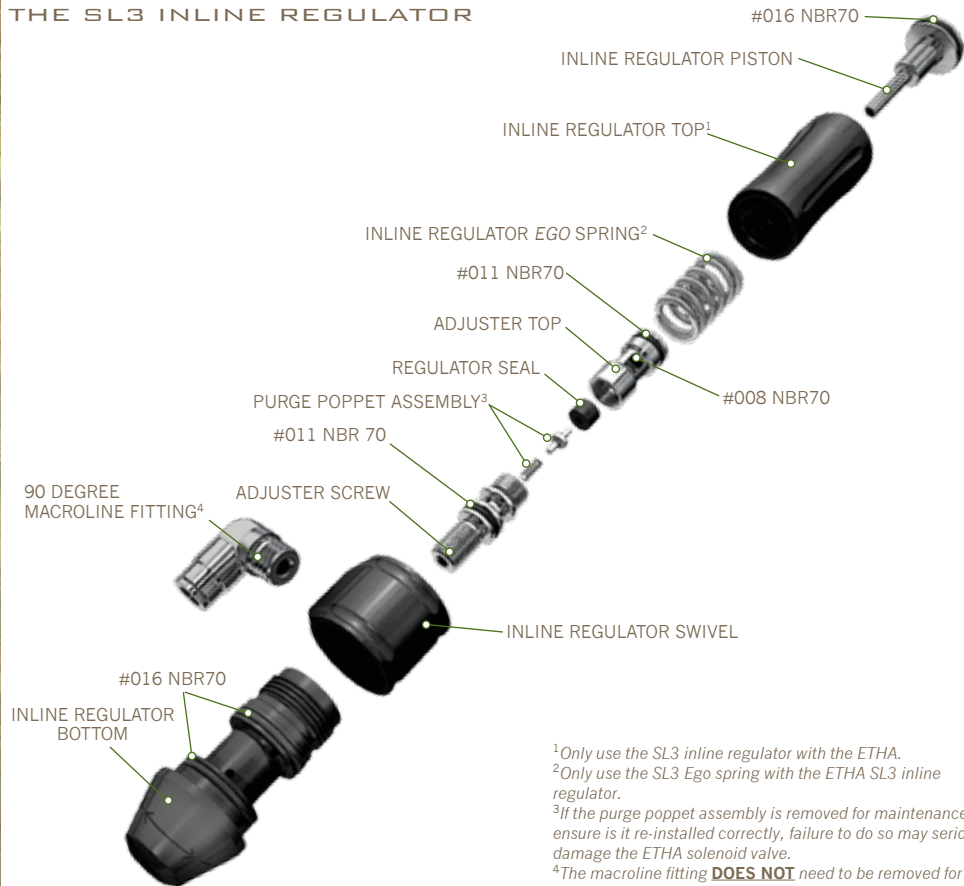

¹ Only use the SL3 inline regulator with the ETHA.

² Only use the SL3 Ego spring with the ETHA SL3 inline regulator.

³ If the purge poppet assembly is removed for maintenance ensure it is re-installed correctly, failure to do so may seriously damage the ETHA solenoid valve.

⁴ The macroline fitting **DOES NOT** need to be removed for regular maintenance.

THE BOLT SYSTEM

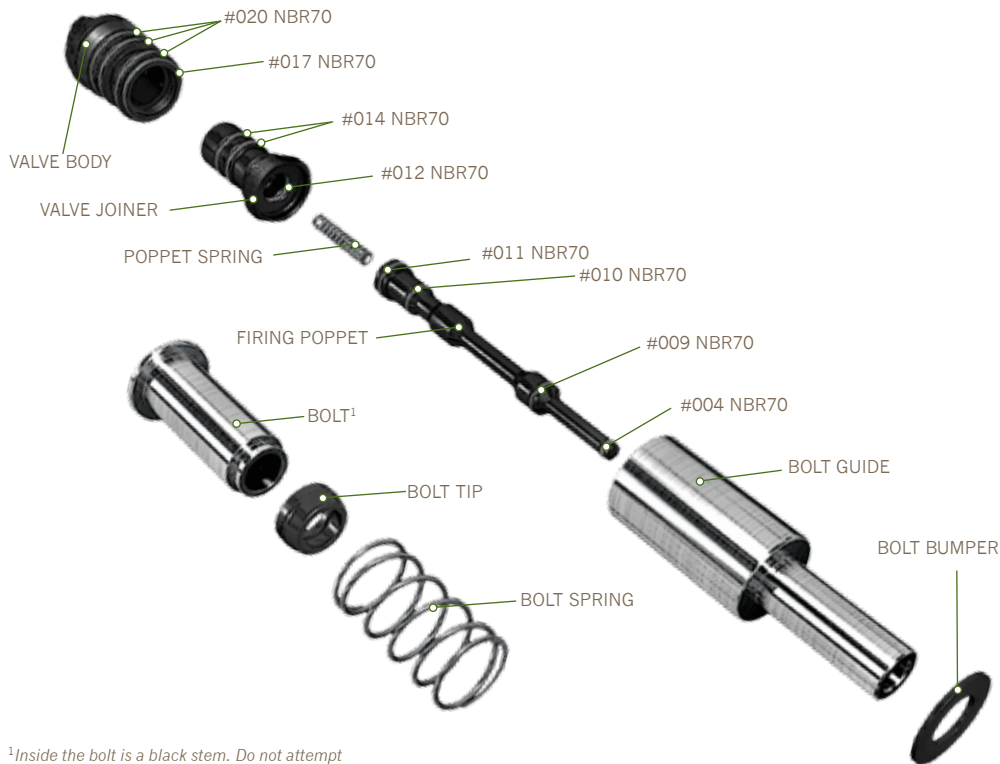

¹Inside the bolt is a black stem. Do not attempt to remove this part from the bolt. Removing this part will void the warranty of the marker.

QUICK GUIDE

CONTENTS
INTRODUCTION
QUICK SET-UP
ORIENTATION
USING THE ETHA
USER INTERFACE
MAINTENANCE
FAULT FINDING
PARTS LIST
SPARES & ACCESSORIES
INDEX

THE SOLENOID ASSEMBLY

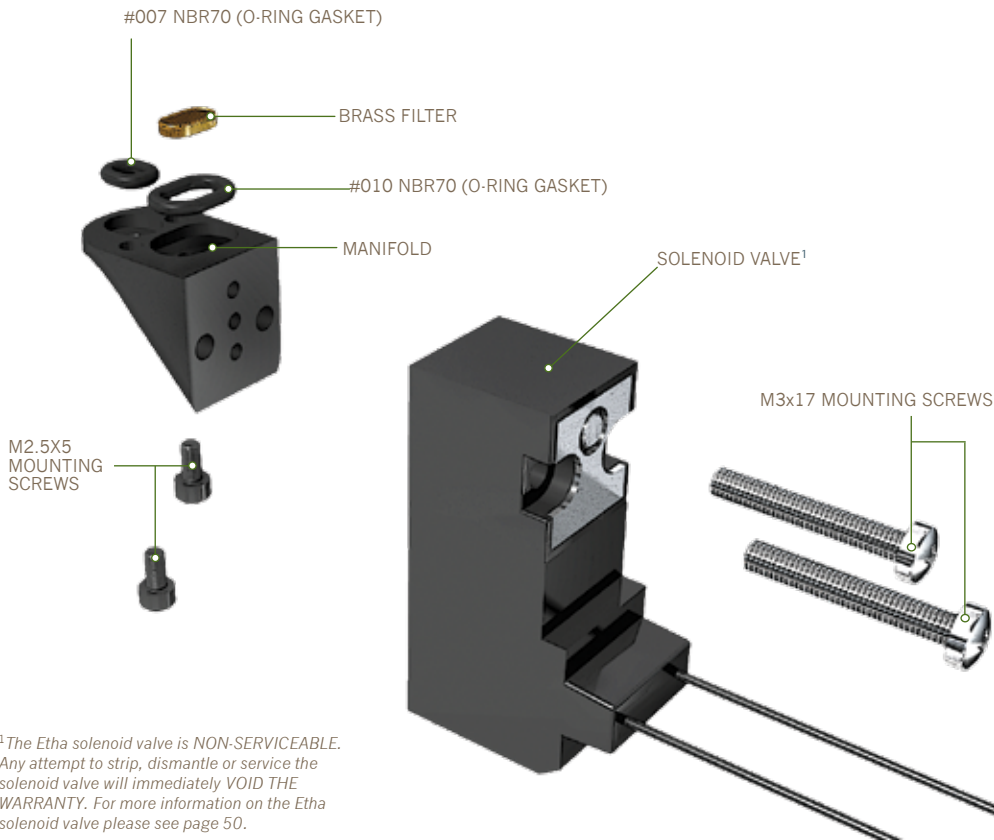

THE ON/OFF PURGE SYSTEM (OOPS)

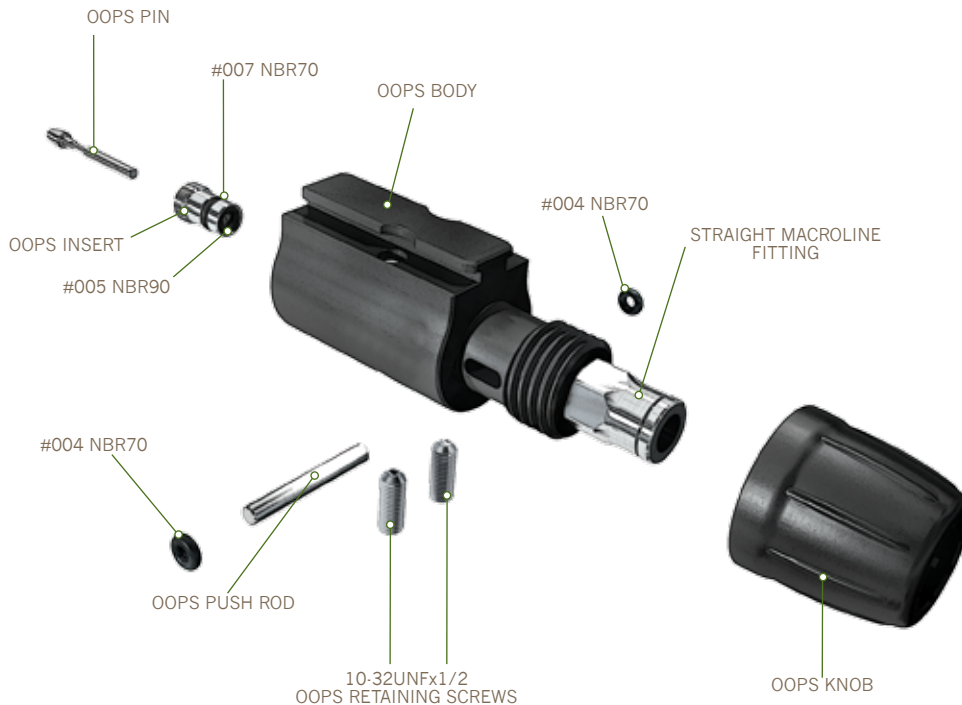

QUICK GUIDE

CONTENTS
INTRODUCTION
QUICK SET-UP
ORIENTATION
USING THE ETHA
USER INTERFACE
MAINTENANCE
FAULT FINDING
PARTS LIST
SPARES & ACCESSORIES
INDEX

ORIENTATION

THE ETHA NAVIGATION CONSOLE

The Etha utilises a *tri-colour* LED to display all of the information that the user requires. This can be found on the *navigation console* (FIGURE 4A).

The various functions of both the *select* button  and the LED are outlined below.

The *select* button  is used to:

- Switch the Etha on and off.
- Switch the *BBSS* (eye system) on and off.
- To scroll through parameters and edit parameters.

The LED on the *navigation console* is used to:

- Display the status of the *BBSS* (eye system).
- Display the value of a parameter.
- Display the status of the battery.
- Display power up and power down status.
- Display tournament lock status.
- Display that factory settings have been restored.
- To confirm whether a parameter value has been accepted or rejected.



OPERATIONAL OVERVIEW

Below is a brief overview of what happens during the Etha firing cycle. The location of parts discussed in the text below can be found on pages 56-59.

Assuming the Etha is gassed up and turned on, **FIGURE 5A** shows the marker in its idle position. The *bolt* is held back under the tension from the *bolt spring*, with the *bolt guide* filled with pressurised gas directly from the *inline regulator*. The *firing poppet* is held in its forward position by the *firing poppet spring*, keeping the *bolt guide* sealed.

When the *trigger* is pulled an electrical signal is sent to the *solenoid* which directs a supply of air to the rear of the *firing poppet* (SEE **FIGURE 5B**). The force of this gas is greater than the spring tension pushing the *firing poppet* forward, and the *firing poppet* is pushed back to its rear position. In the *bolt guide* this opens the exhaust port to the *bolt* and seals off the supply port from the *inline regulator*.

The gas pressure in the *bolt guide* forces the *bolt* forward, overcoming the spring tension from the *bolt spring*, this pushes a ball into the breach and closes off the *feed tube*. The internal *stem* of the *bolt* is pushed out of the *bolt guide*, which then fully opens the exhaust port, allowing the pressurized gas in the *bolt guide* to exhaust through the *bolt* propelling a ball (SEE **FIGURE 5C**).

As the *bolt guide* volume empties, the force pushing the *bolt* forwards decreases and the *bolt spring* starts to push the *bolt* back into the *bolt guide* exhaust port. The spring continues to push the *bolt* back up to its rest position against the rear *bolt bumper* (SEE **FIGURE 5D**).

The *solenoid* continues to hold the *firing poppet* in its rear position until the *Dwell time* expires. When this expires the *solenoid* exhausts the supply of air from the rear of the *firing poppet*, removing the force holding the *firing poppet* in this position. The *firing poppet spring* forces the *firing poppet* forwards, closing the exhaust port and opening the supply from the *inline regulator* (SEE **FIGURE 5E**).

The *bolt guide* begins to fill with pressurised gas. The Etha has now completed a full cycle.

FIG 5A

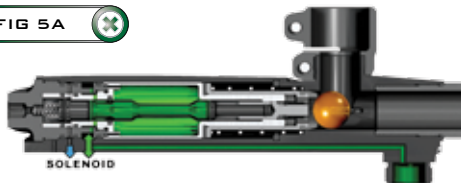

FIG 5B

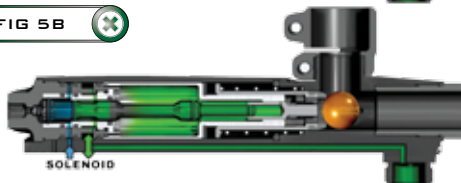

FIG 5C

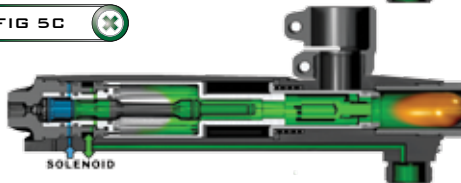

FIG 5D

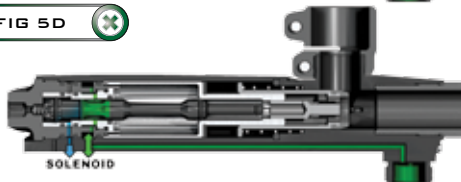
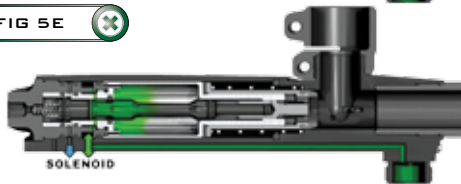

FIG 5E



QUICK GUIDE

CONTENTS

INTRODUCTION

QUICK SET-UP

ORIENTATION

USING THE ETHA

USER INTERFACE

MAINTENANCE

FAULT FINDING

PARTS LIST

SPARES & ACCESSORIES

INDEX

SETTING UP THE ETHA

Before you can begin to use your Etha, you will need to attach a barrel, an air system and a paintball loader.

INSTALLING A BARREL

⚠ WARNING //

MAKE SURE THE MARKER IS TURNED OFF AND THAT NO PAINTBALLS ARE IN THE MARKER OR LOADER BEFORE INSTALLING A BARREL.

Every Etha comes complete with an *Eclipse Shaft4 barrel* (see page 13).

To install the *Shaft4 barrel*, firstly screw the *barrel tip* and *barrel back* sections together. The threads on the *Shaft4 barrel tip* are **reverse threaded**, to screw the two sections together, with the *barrel* pointing away from you, turn the *barrel tip* in a clockwise direction (SEE FIGURE 6A).

While pointing the Etha marker in a safe direction, insert the assembled *Shaft4 barrel* into the front of the *Etha body* and screw the *Shaft4 barrel* into the Etha (in a counter-clockwise direction). Continue to screw the *Shaft4 barrel* into the *Etha body* until the *barrel* becomes tight in the *body*. DO NOT over tighten the barrel (SEE FIGURE 6B).

Install a barrel blocking device over the *barrel* such as the *Eclipse barrel sock* supplied with the Etha¹ (SEE FIGURE 6C). You have now installed the *barrel*.

T-SLOT MOUNTING SYSTEM

The Etha utilises a *T-slot* arrangement to mount the *OOPS* to the bottom of the *frame* (A). There are two retaining screws on the *OOPS* body underside (B). These are used to clamp the *OOPS* onto the frame. It is advisable to make sure that these screws are tight using a 3/8" hex key before attaching an air system (SEE FIGURE 6D).

¹Instruction on using the *Eclipse barrel sock* can be found on the barrel sock warning label.



90 DEGREE MACROLINE FITTING

A 90 degree *macroline fitting* can be found on the SL3 *inline regulator* as shown in **FIGURE 7A**. This fitting is secured into the *inline regulator* using *thread lock* and DOES NOT need to be removed for regular maintenance of the SL3 *inline regulator*.

STRAIGHT MACROLINE FITTINGS

A Straight *macroline fitting* can be found on the OOPS as shown in **FIGURE 7B**. This fitting is secured to the OOPS using *thread lock* and DOES NOT need to be removed for regular maintenance of the OOPS.

MACROLINE HOISING

To aid the longevity of your *macroline* hosing, it is very important to remove it from and install it back into the fittings in the correct manner:

Pull back the collet section of the hose fitting and keep the collet depressed. Pull the *macroline* hose out of the hose fitting and release the collet.

Before installing the *macroline* hose into the fitting ensure that the end has been trimmed correctly and is the correct length to ensure a tight fit in the hose fitting.

FIG 7A



FIG 7B



⚠ WARNING //

IF THE MACROLINE BECOMES WORN, DAMAGED OR IS THE WRONG LENGTH, REPLACE IT IMMEDIATELY.

REPLACE THE MACROLINE HOSE WITH THE FOLLOWING GRADE OR HIGHER -
1/4" OD X 1/8" ID SEMI RIGID NYLON 11
IF UNSURE CONTACT YOUR NEAREST ECLIPSE SERVICE CENTRE

INSTALLING A PRESET AIR SYSTEM**⚠ WARNING //**

MAKE SURE THE MARKER IS TURNED OFF WITH A BARREL BLOCKING DEVICE INSTALLED AND THAT NO PAINTBALLS ARE IN THE MARKER OR LOADER BEFORE INSTALLING AN AIR SYSTEM.

COMPRESSED AIR AND NITROGEN SYSTEMS CAN BE EXTREMELY DANGEROUS IF HANDLED OR USED INCORRECTLY.

ONLY USE A AIR SYSTEM CERTIFIED FOR USE WITHIN THE COUNTRY OF USE

THE ETHA CANNOT BE USED WITH CO2. ONLY USE COMPRESSED AIR OR NITROGEN.

NEVER ADD ANY LUBRICANTS OR GREASES INTO THE FILL ADAPTER OF THE AIR SYSTEM REGULATOR

ENSURE THAT ALL SCREWS ARE TIGHTENED AND NO PARTS ARE LOOSE BEFORE INSTALLING AN AIR SYSTEM

DO NOT PRESSURISE THE ETHA WITHOUT THE BOLT SYSTEM CORRECTLY INSTALLED, AS HIGH PRESSURE GAS WILL BE EMITTED.

DO NOT INSTALL A COMPRESSED AIR SYSTEM OR LOAD PAINTBALLS INTO THE ETHA UNTIL YOU FEEL COMPLETELY CONFIDENT WITH YOUR ABILITY TO HANDLE THE MARKER SAFELY AND RESPONSIBLY.

ALWAYS RELIEVE ALL RESIDUAL GAS PRESSURE FROM THE ETHA BEFORE UNSCREWING THE PRESET AIR SYSTEM.



(CONTINUED)

High, mid and low pressure output preset air systems can be used with the Etha, providing the Etha is fitted with the *SL3 inline regulator* originally supplied with the marker.

The Eclipse Etha comes complete with an *Eclipse On/Off Purge System (OOPS)* which provides a direct connection for a preset air system. Before screwing an air system into the *OOPS* ensure that the *OOPS knob* is fully unscrewed (SEE FIGURE 8A). In this position the *OOPS* is off and will not pressurise the Etha when an air system is screwed into the *OOPS*.

Lining the threads up correctly between the *OOPS* and the air system, screw the air system into the *OOPS* until the air system is screwed all the way in and tight on the *OOPS*. The air system **MUST** be screwed all the way in before turning on the *OOPS* (SEE FIGURE 8B).

Now with the air system attached and the barrel pointing away from you, start to slowly turn the *OOPS knob* counter-clockwise to turn the 'OOPS' on and pressurise the Etha. Keep turning the *knob* until it stops against the *OOPS body* as shown in FIGURE 8C.

You have now installed a preset air system onto your Etha.



QUICK GUIDE

CONTENTS
INTRODUCTION
QUICK SET-UP
ORIENTATION
USING THE ETHA
USER INTERFACE
MAINTENANCE
FAULT FINDING
PARTS LIST
SPARES & ACCESSORIES
INDEX

ATTACHING A LOADER

⚠ WARNING //

DO NOT OVER TIGHTEN THE CLAMPING FEED NECK AS THIS MAY DAMAGE THE LOADER OR FEED NECK ITSELF.

Release the *clamping lever* on the *feed neck* (SEE FIGURE 9A) and test to see if your loader can easily be pushed into the top of the *feed neck*. If the loader cannot easily be pushed into the *feed neck*, loosen the top screw on the *feed neck* by turning it counter-clockwise using a 5/32" hex key (SEE FIGURE 9B).

When you have managed to push your loader into the *feed neck*, close the *clamping lever* to secure it firmly in place (SEE FIGURE 9C). If the loader is loose then you will need to release the *clamping lever*, tighten the top screw slightly by turning it clockwise with a 5/32" hex key (SEE FIGURE 9B), then close the *clamping lever*. Repeat this process as necessary to secure your loader in place.

You have now attached a loader to your Etha. Once you have filled your loader and air tank you will then be ready to begin using your Etha.



CONTENTS
INTRODUCTION
QUICK SET-UP
ORIENTATION
USING THE ETHA
USER INTERFACE
MAINTENANCE
FAULT FINDING
PARTS LIST
SPARES & ACCESSORIES
INDEX

SETTING THE TRIGGER

There are three adjustment points on the *trigger* – the *front stop trigger screw*, the *rear stop trigger screw* and the *spring return strength screw*. As standard each Etha comes with a factory set trigger travel of approximately 6mm in total length; 3mm of travel before the firing point and 3mm of travel after the firing point.

The *front stop trigger screw* is used to set the amount of trigger travel prior to the marker firing. Turn this screw clockwise to reduce the amount of travel. Do not turn the screw too far or the *trigger* will be pushed past the firing point and the marker will not work. Turn this screw counter-clockwise to increase the amount of travel (SEE FIGURE 10A).

The *rear stop trigger screw* is used to set the amount of travel after the marker has fired. Turn this screw clockwise to reduce the amount of travel. Do not turn the screw too far or the *trigger* will be prevented from reaching its firing point and the marker will not work. Turn this screw counter-clockwise to increase the amount of travel (SEE FIGURE 10B).

The *spring return strength screw* is used to adjust the spring strength that returns the *trigger* to its resting position. Turn the screw clockwise to increase the amount of spring return strength in the trigger pull. Turn this screw counter-clockwise to reduce the amount of spring return strength in the trigger pull. Do not turn the screw too far counter-clockwise or there will not be enough force to return the *trigger* consistently (SEE FIGURE 10C).

Reference FIGURE 10D

- A - FRONT STOP TRIGGER SCREW
- B - TRIGGER PIN LOCKING SCREW
- C - TRIGGER SPRING RETURN STRENGTH SCREW
- D - REAR STOP TRIGGER SCREW
- E - MICRO-SWITCH CONTACT POINT
- F - TRIGGER SPRING
- G - TRIGGER PIN

¹ The *trigger pin locking screw* does nothing to adjust/set the trigger and should be left tight against the trigger pin.

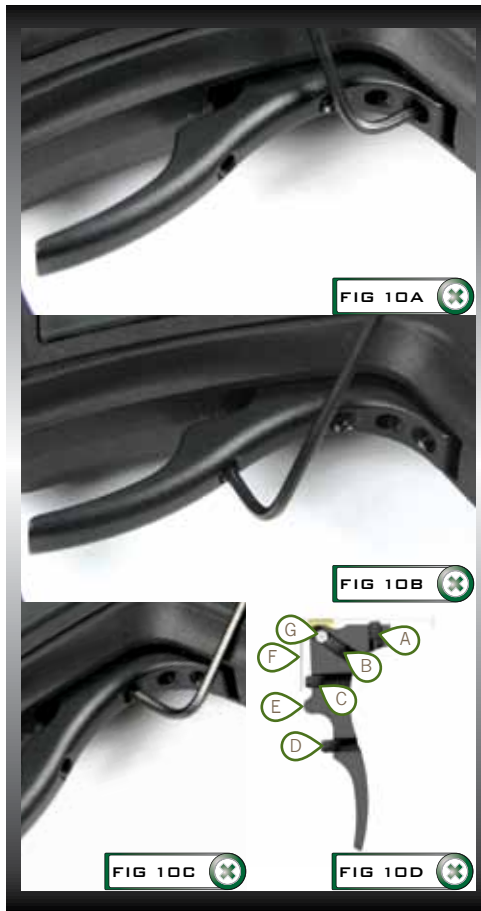

ADJUSTING THE VELOCITY

⚠ WARNING //

CHECK THE VELOCITY OF THE MARKER AT REGULAR INTERVALS DURING USE. MANY EXTERNAL FACTORS CAN EFFECT THE VELOCITY THE MARKER FIRES AT SUCH AS; AMBIENT AIR TEMPERATURE AND PRESSURE, SIZE OF PAINTBALLS BEING USED AND BARREL BORE SIZE.

When using your Etha, you may wish to change the velocity at which your Etha is firing. This is done by inserting a 1/8" hex key into the *adjuster screw* at the bottom of your *SL3 inline regulator* and adjusting it accordingly (SEE FIGURE 11A).

By turning the *adjuster screw* clockwise you decrease the output pressure of the *inline regulator* and consequently decrease the velocity; by turning the *adjuster screw* counter-clockwise you increase the output pressure of the *inline regulator* and consequently increase the velocity. On the bottom of the *inline regulator* there are engraved arrows to illustrate which direction to turn the hex key to make the relevant adjustment^{1,2}.

Setting the output pressure too high on any *inline regulator* used with the Etha will cause the *solenoid valve* under the *Etha body* to vent gas from its built-in *pressure relief valve*. If this occurs, reduce the output pressure of the *inline regulator*.

¹After each adjustment fire two clearing shots to gain an accurate velocity reading. Never exceed 300fps.

²High, mid and low pressure output preset air systems can be used with the Etha, providing the Etha is fitted with the SL3 inline regulator originally supplied with the marker.



FIG 11A



UNLOADING THE ETHA

⚠ WARNING //////////////////////////////////////

ALWAYS KEEP THE ECLIPSE ETHA POINTED IN A SAFE DIRECTION AND ENSURE ALL PERSONS WITHIN RANGE CONTINUE TO WEAR FACE PROTECTION, UNTIL MARKER IS COMPLETELY UNLOADED AND SAFE.

Securely attach a barrel blocking device such as the *Eclipse barrel sock*¹ (supplied with the Etha) to the marker as shown in **FIGURE 12A**.

Turn off the Etha electronics by holding down the **U** button on the back of the *frame*. When the LED display turns red then extinguishes, the marker has been turned off (**SEE FIGURE 12B**).

With the Etha pointing away from you. De-gas the marker by turning *OOPS knob* clockwise until the *OOPS* begins to vent air. Only when the *OOPS* has fully degassed the Etha marker, unscrew the air system from the *OOPS* (**SEE FIGURE 12C**).

Open the *clamping lever* on the *feed neck* and slacken off the top feed screw if necessary on the *feed neck*. Carefully pull the loader out of the *feed neck* (**SEE FIGURE 12D**).

Looking down the *feed neck*, check to see if there are any paintballs still in the breech, if there are, turn the marker upside down while still keeping the barrel facing away from any persons within firing range then tip out any paintballs within the breech (**SEE FIGURE 12E**).

Next remove the barrel blocking device, and unscrew the *barrel* (**SEE FIGURE 12F**). Remove any paintballs within the *barrel*.

The Eclipse Etha has now been unloaded and is ready for storage.

¹Instruction on using the Eclipse barrel sock can be found on the sock warning label.



QUICK GUIDE

CONTENTS
INTRODUCTION
QUICK SET-UP
ORIENTATION
USING THE ETHA
USER INTERFACE
MAINTENANCE
FAULT FINDING
PARTS LIST
SPARES & ACCESSORIES
INDEX

CAUTION: NEVER CARRY YOUR ECLIPSE ETHA UN-CASED WHEN NOT ON A PLAYING FIELD. THE NON-PLAYING PUBLIC AND LAW ENFORCEMENT PERSONNEL MAY NOT BE ABLE TO DISTINGUISH BETWEEN A PAINTBALL MARKER AND A REAL FIREARM. FOR YOUR OWN SAFETY AND TO PROTECT THE IMAGE OF PAINTBALL, ALWAYS CARRY THE ECLIPSE ETHA (OR ANY OTHER PAINTBALL MARKER) IN A SUITABLE MARKER CASE SUCH AS THE ONE IN WHICH IT WAS SUPPLIED.

- Your Eclipse Etha must be clear of all paint and propellant during transportation or storage.
 - Make sure the Eclipse Etha marker is off.
 - Remove the Barrel from the marker.
 - Make sure the marker is clean of any paint residue, dirt and moisture.
 - Store your Eclipse Etha in a clean, cool, dry place.
 - Keep your Eclipse Etha away from any unauthorized and unsafe users.
 - It may be a good idea to remove the battery when storing your Eclipse Etha to prevent unauthorized use.
 - Protect your Eclipse Etha from excessive heat during transportation.
 - When transporting a paintball marker by air, check with the airline regarding their policies on transporting paintball equipment as hold luggage before arriving at the airport.
 - Observe and obey all local and national laws concerning the transportation of paintball markers. For information concerning any of the laws in your area, contact your nearby law enforcement agency.
- When shipping the Eclipse Etha for any reason, Planet Eclipse recommends using the box in which the marker was originally supplied to protect the marker against rough handling during transport.

THE TOURNAMENT LOCK

⚠ WARNING ///

ALWAYS KEEP THE ECLIPSE ETHA POINTED IN A SAFE DIRECTION AND ENSURE ALL PERSONS WITHIN RANGE CONTINUE TO WEAR FACE PROTECTION, UNTIL MARKER IS COMPLETELY UNLOADED AND SAFE.

The Etha has an electronic *tournament lock* which, once enabled, prevents the user from making any changes to the setup parameters of the marker. This *tournament lock* complies with the rules of all major tournaments and must be enabled prior to entering the field of play in order to avoid penalties.

The Etha is shipped from the factory with the Tournament Lock disabled.

To enable the Tournament lock;

1. Remove the right side *grip panel* by unscrewing the retaining screw using a 5/64" hex key (SEE FIGURE 13A).
2. Turn on the Etha.
3. Locate and press the *tournament lock* button on the *circuit board* (SEE A FIGURE 13B). The *navigation console* will flash green to indicate that the *tournament lock* has been enabled.
4. Replace the right side *grip panel* then the retaining screw using a 5/64" hex key.

To disable the tournament lock;

1. Remove the right side *grip panel* by unscrewing the retaining screw using a 5/64" hex key (SEE FIGURE 13A).
2. Turn on the Etha.
3. Locate and press the *tournament lock* button on the *circuit board* (SEE A IN FIGURE 13B). The *navigation console* will flash red to indicate that the *tournament lock* has been disabled.
4. Replace the right side *grip panel* then the retaining screw using a 5/64" hex key.



FIG 13A

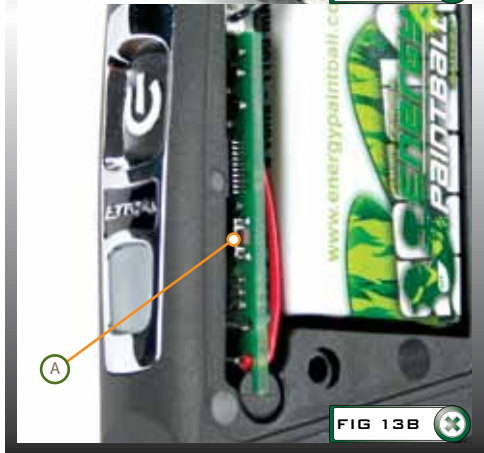

FIG 13B

QUICK GUIDE

CONTENTS

INTRODUCTION

QUICK SET-UP

ORIENTATION

USING THE ETHA

USER INTERFACE

MAINTENANCE

FAULT FINDING

PARTS LIST

SPARES & ACCESSORIES

INDEX

USING THE ETHA

UNDERSTANDING THE BBSS OPERATION

The Etha displays the status of the *Break Beam Sensor System* using the LED on the *navigation console* as follows:

INDICATION	BREACH SENSOR STATUS
Flashing Yellow	BBSS enabled (On), no paintball detected - marker will not fire.
Flashing Light Blue	BBSS enabled (On), paintball detected - marker will fire.
Flashing Purple	BBSS disabled (Off) - marker will fire.
Fast Flashing Purple	Blockage detected, BBSS temporarily disabled (Off) - marker will fire.

Any changes to the breach sensor status will be displayed immediately. This provides valuable feedback to the user.

An example of this is when you are shooting a string of shots with the *BBSS* enabled, the LED on the *navigation console* will alternate in colour from yellow (no paintball detected) to light blue (paintball detected). In this instance too much yellow would indicate that your chosen loader cannot keep up with how fast you are shooting and is consequently slowing down your rate of fire.

The *BBSS* is able to switch itself off in the event that a blockage or contamination prevents it from functioning correctly. This is represented by a fast flashing purple LED on the *navigation console*. The Etha's ROF will be capped at 7.5bps. In this instance, the *BBSS* will switch itself back on once the blockage is cleared and the correct operation of the *BBSS* can then be resumed.

THE BATTERY LEVEL INDICATOR

When the Etha is turned on, the level of the battery will be displayed on the LED (after an initial blue flash¹ signifying the Etha has powered on).

The status of the battery can be displayed manually on the LED by quickly pressing and releasing  on the *navigation console*.

When the battery is fresh the LED will flash green. As the battery is drained the LED will change colour from green to yellow then red.

When the battery reaches a level where it will no longer function reliably, the LED will start to flash red. At this point the battery must be changed for a new one. For instructions on installing a new battery see page 11.

¹ The colour of this flash may vary depending on the region the marker has originally been purchased.

⚠ WARNING //

WHEN THE BATTERY LEVEL INDICATOR IS BEING DISPLAYED THE MARKER IS STILL ON AND WILL FIRE IF THE TRIGGER IS PULLED (DEPENDANT ON THE CONDITION OF THE BBSS).

THE SET UP MODE

The *set up mode* can only be entered if the *tournament lock* is off. See page 29 for details on the *tournament lock*.

To activate the *set up mode*, firstly ensure that the Etha is switched off. Pull and hold the *trigger* down, and whilst the *trigger* is still pulled, push and hold the **U** button until the LED on the *navigation console* flashes white to indicate entry into the *set up mode*. Release the *trigger* and the **U** button, the LED on the *navigation console* will turn red to indicate the first set up parameter.

Press the **U** button to scroll through each of the set up parameters:

COLOUR	PARAMETER	RANGE
Red	Firing Mode	1 to 4
Green	Maximum ROF with BBSS on (capped modes only).	4.0 bps to 15.0 bps
Blue	Maximum ROF with BBSS off.	4.0 bps to 15.0 bps
Purple	Dwell	1.0 ms to 15.0 ms
Light Blue	Debounce	1 to 10

To see the value of the selected parameter, pull and quickly release the *trigger*. The value will be indicated in units (long flashes) and then tenths (short flashes) on the LED display in the colour of the selected parameter.

E.g. A Dwell of 14.5ms would be indicated as follows-

- 14 LONG FLASHES OF A PURPLE LED
- 5 SHORT FLASHES OF A PURPLE LED

A zero is indicated by no flashes. E.g. A *Dwell* of 11.0ms would be indicated as follows:

- 11 LONG FLASHES OF A PURPLE LED
- 0 SHORT FLASHES OF A PURPLE LED

MODIFYING A PARAMETER

You can modify a parameter by using the following guidelines.

1. Ensure that you are in *set up mode*.
2. Choose the parameter that you wish to modify by pressing **U** until the LED turns to the parameter colour.
3. Pull and hold the *trigger* for 1 second. The LED will go off.
4. Set the units value by pulling the *trigger* once for each unit, the LED will flash with each *trigger* pull.
5. Push the **U** button to switch to the tenths value¹.
6. Set the tenths value by pulling the *trigger* once for each unit, the LED will flash with each *trigger* pull. DO NOT pull the *trigger* if the required digit is zero¹.
7. Push the **U** button. The LED will flash three times; if the colour is green then the value has been accepted and saved. If the colour is red then the value has been rejected and remains unchanged.

For example to set a parameter to 14.5 when following the steps above -

- PULL THE TRIGGER 14 TIMES WHEN AT STEP 4 THEN PRESS **U**

- PULL THE TRIGGER 5 TIMES WHEN AT STEP 6 THEN PRESS **U**

To leave a parameter unchanged having already started to modify it, do not pull the *trigger* for 5 seconds and the value will be rejected.

EXITING SET UP MODE

To exit *set up mode*, push and hold the **U** button until the LED turns blue. Then release the **U** button, the Etha will exit *set up mode* and the LED will start flashing, displaying the current BBSS status.

¹If the parameter does not support tenths then these steps are skipped.

QUICK GUIDE

CONTENTS
INTRODUCTION
QUICK SET-UP
ORIENTATION
USING THE ETHA
USER INTERFACE
MAINTENANCE
FAULT FINDING
PARTS LIST
SPARES & ACCESSORIES
INDEX

SET UP PARAMETERS

The first three set up parameters will need to be set to comply with the rules of the field or site at which this Etha is used. It is the user's responsibility to ensure that these parameters are correctly set.

THE FIRING MODE PARAMETER

This parameter is used to control the firing mode of the Etha. The *firing mode* parameter is indicated by a red light on the *navigation console* when you are in the *set up mode*. There are four selectable firing modes as outlined below:

1 : UNCAPPED SEMI

In this mode the Etha will fire one shot for every pull of the *trigger*. This mode is uncapped with the *BBSS* enabled. If the *BBSS* is off then the rate of fire is limited by the *Maximum ROF with BBSS Off* parameter.

2 : CAPPED SEMI

This mode is the same as the *Uncapped Semi* mode, except that the rate of fire (ROF) is determined by the maximum ROF parameters (BBSS On and BBSS Off).

3 : PSP 2011 COMPLIANT RAMPING

This mode allows the marker to fire in a ramping mode as specified in the 2011 PSP Series rules.

4 : MILLENNIUM 2010 COMPLIANT RAMPING

This mode allows the marker to fire in a ramping mode as specified by the 2010 Millennium Series rules.

Certain modes may only be available in certain countries and on certain models of the Etha.



THE MAXIMUM ROF WITH BBSS ON (CAPPED MODES)

In capped firing modes this parameter is used to control how fast the Etha can cycle.

The *Maximum ROF with BBSS On* parameter is indicated by a green light on the *navigation console* when you are in the *set up mode*.

This is fully adjustable between 4.0 balls per second and 15.0 balls per second in 0.1 bps increments.



THE MAXIMUM ROF WITH BBSS OFF

This parameter is used to control how fast the Etha cycles when the *Break Beam Sensor System* has been disabled.

The *Maximum ROF with BBSS Off* parameter is indicated by a blue light on the *navigation console* when you are in the *set up mode*.

This parameter is fully adjustable between 4.0 balls per second and 15.0 balls per second in 0.1 bps increments.

This parameter should be set to match the slowest speed of the loading system in use.



The remaining set up parameters are used to configure the performance of the Etha.

DWELL

The *Dwell* parameter controls the amount of time that the *solenoid valve* is energised and therefore the amount of gas that is released with each shot.

The *Dwell* parameter is indicated by a purple light on the *navigation console* when you are in the *set up mode*.

This parameter is fully adjustable between 1.0ms and 15.0ms in 0.1ms increments.



DEBOUNCE

The *Debounce* parameter is used to set the level of Debounce (anti-trigger bounce) on the Etha.

The *Debounce* parameter is indicated by a 'light blue' LED on the *navigation console* when you are in the *set up mode*.

This parameter is fully adjustable between Debounce 1 and Debounce 10 with a higher value reducing the amount of trigger bounce.



THE FACTORY RESET

Whilst in *set up mode*, it is possible to reset all of the control parameters to the factory default settings in the following way:

1. Push and hold the *Tournament Lock* button (see page 29 for information on the *Tournament Lock* button) for two seconds.
2. The LED on the *navigation console* will repeatedly flash blue to indicate that the factory default settings have been restored.



QUICK GUIDE

CONTENTS
INTRODUCTION
QUICK SET-UP
ORIENTATION
USING THE ETHA
USER INTERFACE
MAINTENANCE
FAULT FINDING
PARTS LIST
SPARES & ACCESSORIES
INDEX

THE BREAK BEAM SENSOR SYSTEM (BBSS)

⚠ WARNING //////////////////////////////////////
DE-GAS YOUR MARKER, DISCHARGING ANY
STORED GAS IN A SAFE DIRECTION, AND REMOVE
THE BARREL, LOADER, AIR SYSTEM AND ANY
PAINTBALLS TO MAKE THE MARKER EASIER AND
SAFER TO WORK ON.

Undo the retaining screw for the *BBSS* cover on the right hand side of the *Etha* body using a 5/64" (2mm) hex key (SEE FIGURE 14A).

Remove the cover to expose the back of the *sensor unit* (SEE FIGURE 14B). Using a dry cotton bud, carefully remove any debris, paint or moisture from the back of the *sensor unit* and from inside the *BBSS* cover.

Lift the *sensor unit* free from the *Etha* body and using another dry cotton bud, remove any grease or debris build-up from the front face of the *sensor unit* (SEE FIGURE 14C), then clean the sensor channel and hole on the *Etha* body.



FIG 14A



FIG 14B



FIG 14C

CONTENTS
INTRODUCTION
QUICK SET-UP
ORIENTATION
USING THE ETHA
USER INTERFACE
MAINTENANCE
FAULT FINDING
PARTS LIST
SPARES & ACCESSORIES
INDEX

(CONTINUED)

Remove the *Detent* and using a dry cotton bud clean the *Detent* and its location point in the *Etha body*. Inspect the *Detent* for damage and replace if necessary (SEE FIGURE 14D)¹.

Insert the *Detent* into the *Etha body* (SEE FIGURE 14E) and place the *sensor unit* back into the designated slot in the *body* (SEE FIGURE 14B). Ensure that the *sensor unit* is face down in the *body* i.e. looking into the breach².

Replace the *BBSS cover*, then using a 5/64" hex key tighten the *BBSS cover* retaining screw into the *body* (SEE FIGURE 14F). Do not over tighten the retaining screw.

Repeat the procedure for the opposite side of the *Etha*.

You have now cleaned your *Break Beam Sensor System*.



FIG 14D



FIG 14E



FIG 14F

¹Replace any worn/damaged parts using authentic Eclipse Etha spare parts.

²Ensure that the receiver sensor (indicated by red heat shrink sleeving) is located on the right-hand side of the marker body.

⚠ WARNING **IF YOU ARE AT ALL UNSURE OF PERFORMING A MAINTENANCE PROCEDURE PLEASE CONTACT YOUR NEAREST SERVICE CENTRE.**

THE SL3 INLINE REGULATOR

⚠ WARNING //////////////////////////////////////
DE-GAS YOUR MARKER, DISCHARGING ANY STORED GAS IN A SAFE DIRECTION, AND REMOVE THE BARREL, LOADER, AIR SYSTEM AND ANY PAINTBALLS TO MAKE THE MARKER EASIER AND SAFER TO WORK ON.

Disconnect the *macroline* hoses from your *inline regulator* by pulling back the collet section of the hose fitting and keeping the collet depressed. Pull the *macroline* hose out of the hose fitting and release the collet.

Unscrew the *inline regulator* from the *Etha* body in a clockwise direction (SEE FIGURE 15A). Inspect the o-ring at the top of the threads on the *Etha* body for damage. Replace and re-lubricate as necessary¹.

Turn the *inline regulator* upside down and carefully unscrew the bottom section from the top section (SEE FIGURE 15B).

Tip both the *piston* and *spring* out of the top of the *inline regulator* (SEE FIGURE 15C).

Insert a 1/8" hex key into the *adjuster screw* in the bottom section of the *inline regulator*, turn the *adjuster screw* clockwise through the top of the *inline regulator bottom* (SEE FIGURE 15D), and pull out of the *inline regulator bottom* when it will no longer turn upwards².

Thoroughly clean the O11 NBR70 o-rings that sit on the outside of the *adjuster assembly*, then re-lubricate with Eclipse Grease (SEE OVERLEAF FIGURE 15E)¹.

¹If any o-rings are damaged then replace them. Extra o-rings are available in parts kits available at www.planeteclipse.com

²The *adjuster screw* can only be removed by turning it upwards through the bottom section of the *inline regulator*. The regulator may be damaged if the *adjuster screw* is removed incorrectly.



(CONTINUED)

Using a dry cotton bud, clean the internal O08 NBR70 o-ring that sits inside the top section of the *adjuster assembly*. Then using a small hex key gently apply Eclipse Grease to the o-ring (SEE FIGURE 15F)¹.

At this point if you are maintaining the *inline regulator* to fix a supercharging issue, turn to page 38 to the 'ADVANCED SL3 INLINE REGULATOR MAINTENANCE' section. If you are not fixing a supercharging issue then there is no need to perform this advanced maintenance procedure.

Re-install the *adjuster assembly* into the bottom section of the *inline regulator* threaded end first. Apply light pressure to the top of the *adjuster assembly*, while using a 1/8" hex turn the *adjuster screw* counter-clockwise until it stops at the base of the *inline regulator* (SEE FIGURE 15G). Then turn the *adjuster screw* back in 2^{1/2} turns to set an *inline regulator* output pressure that will not damage the marker when it is 'gassed up'.

Take the *piston*, inspect for damage and clean the O16 NBR70 o-ring at the top, re-lubricating it with a light application of Eclipse Grease (SEE FIGURE 15H). Place the *inline regulator spring* over the *piston*, then insert the *piston* and *spring* into the top of the *inline regulator top section* (SEE FIGURE 15I)¹. Holding the *piston* and *spring* in place, screw the top and bottom sections of the *inline regulator* together.

Screw the *inline regulator* onto the *Etha body* in a counter-clockwise direction (SEE FIGURE 15J), then re-connect the *macroline* hose to the fitting on the *regulator swivel*. Basic cleaning of the *inline regulator* is complete.

¹If any o-rings are damaged then replace them. Extra o-rings are available in parts kits available at www.planeteclipse.com.

⚠ WARNING **IF YOU ARE AT ALL UNSURE OF PERFORMING A MAINTENANCE PROCEDURE PLEASE CONTACT YOUR NEAREST SERVICE CENTRE.**



⚠ WARNING

THE SPRING IN THE ETHA INLINE REGULATOR HAS BEEN DESIGNED SPECIFICALLY FOR USE WITH THE ECLIPSE ETHA. USING ANY OTHER SPRING WILL DAMAGE THE ETHA AND VOID YOUR WARRANTY.

QUICK GUIDE

CONTENTS
INTRODUCTION
QUICK SET-UP
ORIENTATION
USING THE ETHA
USER INTERFACE
MAINTENANCE
FAULT FINDING
PARTS LIST
SPARES & ACCESSORIES
INDEX

ADVANCED SL3 INLINE REGULATOR MAINTENANCE

⚠ WARNING //
DE-GAS YOUR MARKER, DISCHARGING ANY STORED GAS IN A SAFE DIRECTION, AND REMOVE THE BARREL, LOADER, AIR SYSTEM AND ANY PAINTBALLS TO MAKE THE MARKER EASIER AND SAFER TO WORK ON.

This procedure is only required if you are fixing a supercharging *SL3 inline regulator* (common symptoms of supercharging are a very high velocity first shot and/or large variances in shot to shot consistency).

Place a 3/32" hex key through the *adjuster top* section (SEE FIGURE 16A), then insert a 1/8" hex key into the bottom of the *adjuster screw* and carefully turn it counter-clockwise until the two parts begin to unscrew freely (SEE FIGURE 16B). With your fingers fully unscrew the two parts taking care not to lose any of the internal components (SEE FIGURE 16C).

Inside the *adjuster screw* **C** you will find a *regulator seal* **A**, *purge poppet* and *spring* **B** (together these two form the *purge poppet assembly*) (SEE FIGURE 16D). Inspect and clean the *regulator seal*, turning it over if one side appears excessively worn or damaged or replace if necessary. Inspect and clean the *purge poppet* or replace if necessary¹.

Place the *purge poppet* and attached *spring* in the central hole in the *regulator seal*, then insert these parts into the *adjuster screw* (SEE FIGURE 16E).

With the *regulator seal*, *purge poppet* and *spring* installed back into the *adjuster screw*, replace the *adjuster top* section (SEE FIGURE 16F). Screw the two parts tightly together using 1/8" and 3/32" hex keys (SEE FIGURE 16B). Refer to the 'THE SL3 INLINE REGULATOR' section on page 37 to re-assemble the SL3 *inline regulator*.

¹If the *Purge Poppet Assembly* is removed for maintenance ensure that it is re-installed correctly, failure to do so may seriously damage the *Etha solenoid valve*.



CLEANING THE BOLT SYSTEM

⚠ WARNING //////////////////////////////////////
DE-GAS YOUR MARKER, DISCHARGING ANY STORED GAS IN A SAFE DIRECTION, AND REMOVE THE BARREL, LOADER, AIR SYSTEM AND ANY PAINTBALLS TO MAKE THE MARKER EASIER AND SAFER TO WORK ON.

Insert a 1/4" hex key into the back of the *Etha* body and unscrew the *bolt system* assembly from the *Etha* body (SEE FIGURE 17A). When the *bolt system* assembly reaches the end of the threads pull the assembly out of the *Etha* body (SEE FIGURE 17B).

Slide the *bolt* and *spring* off the *bolt guide* (SEE FIGURE 17C). Then slide the *bolt spring* off the *bolt* (SEE FIGURE 17D). Remove any paint or debris on the *bolt spring* and inspect it for damage or excessive wear, if necessary replace the *bolt spring*.

Now clean the *bolt* using a cotton bud or soft cloth (SEE FIGURE 17E), removing any old grease, paint or debris on the outside or inside the *bolt*¹. Inspect the *bolt* for damage or excessive wear, paying close attention to the rubber *bolt tip* **A** (SEE FIGURE 17E). Replace the *bolt tip* if there is evidence of damage or excessive wear. To do this, slide a pick between the *bolt tip* and *bolt* (SEE FIGURE 17F), then slide the pick under the *bolt tip* and lever the *bolt tip* off the *bolt* (SEE FIGURE 17G).

To attach a new *bolt tip*, stretch the new *tip* around the edge of the *bolt* (SEE FIGURE 17H) and then push the *bolt tip* onto the *bolt* until it locates in the groove on the *bolt*. The back of the *bolt tip* should be flush with the *bolt*. Slide the *bolt spring* over the *bolt* to reassemble the *bolt* sub-assembly.

¹Inside the *bolt* is a black stem, do not attempt to remove this part from the *bolt*. Removing this part will void the warranty of the *Etha*.



QUICK GUIDE

CONTENTS
INTRODUCTION
QUICK SET-UP
ORIENTATION
USING THE ETHA
USER INTERFACE
MAINTENANCE
FAULT FINDING
PARTS LIST
SPARES & ACCESSORIES
INDEX

(CONTINUED)

⚠ WARNING //
DE-GAS YOUR MARKER, DISCHARGING ANY STORED GAS IN A SAFE DIRECTION, AND REMOVE THE BARREL, LOADER, AIR SYSTEM AND ANY PAINTBALLS TO MAKE THE MARKER EASIER AND SAFER TO WORK ON.

Next unscrew the *bolt guide* from the *valve assembly* (SEE FIGURE 17I). Clean the *bolt guide*, removing any old grease, debris or paint from the front, narrow *stem* section (SEE FIGURE 17J) and the exhaust port inside the *bolt guide* (SEE FIGURE 17K). Clean and inspect the rear *bolt bumper* (SEE FIGURE 17L) for damage or excessive wear, reverse or replace as necessary.

The *valve* itself contains four components, the *valve body*, the *firing poppet*, the *poppet spring* and the *valve joiner*.

Start by unscrewing the *valve joiner* from the *valve body*, gripping the flats on the side of the threads (SEE FIGURE 17M). When unscrewed, slide the *valve joiner* and *firing poppet* out of the *valve body* (SEE FIGURE 17N). Remove the *poppet spring* and place to one side. With the *valve joiner* and *firing poppet* removed from the *valve body*, push the *firing poppet* out the back of the *valve joiner* (SEE FIGURE 17O).

Take the *firing poppet* and clean and inspect the metal shaft and o-rings with a cotton bud or soft cloth, removing any old grease or debris (SEE FIGURE 17P). Replace any damaged components on the *firing poppet*.

⚠ WARNING //
IF YOU ARE AT ALL UNSURE OF PERFORMING A MAINTENANCE PROCEDURE PLEASE CONTACT YOUR NEAREST SERVICE CENTRE.



CONTENTS
INTRODUCTION
QUICK SET-UP
ORIENTATION
USING THE ETHA
USER INTERFACE
MAINTENANCE
FAULT FINDING
PARTS LIST
SPARES & ACCESSORIES
INDEX

(CONTINUED)

Moving onto the *valve body*: clean the three o-rings and the *valve body* itself (SEE FIGURE 17Q). Inspect the o-rings and internal bore of the *valve body* for damage and wear. Replace the o-rings as necessary. Inspect the two sets of air ports labelled **A** in FIGURE 17Q, making sure all the ports are free of any debris.

Lastly take the *valve joiner* and clean the *joiner shaft*, external o-rings and two sets of air ports **B** (SEE FIGURE 17R). Also clean the one internal o-ring and internal bore (SEE FIGURE 17S), making sure the entire component is free of debris and old grease. Inspect the three o-rings on the *valve joiner* for damage and replace as necessary.

The *bolt system assembly* has now been fully disassembled and cleaned, ready for lubrication and re-assembly.



FIG 17Q

FIG 17R

FIG 17S

(CONTINUED)

Using a cotton bud apply a thin film of grease to the inside of the exhaust port on the *bolt guide*¹ (SEE FIGURE 18I). Apply grease to the smaller front o-ring on the *valve body* (SEE FIGURE 18J). Then, being careful not to scratch the inside of the *bolt guide* with the *firing poppet* shaft, slide the *valve body* into the *bolt guide* (SEE FIGURE 18K) and then screw the two parts together.

Now apply a thin coat of grease to the three exposed o-rings on the *valve body* (SEE FIGURE 18L), making sure not to block the gas ports on the *valve body* with grease.

Take the *bolt* and *bolt spring* and slide them onto the *bolt guide* (SEE FIGURE 18M). The *bolt system assembly* has now been fully assembled.

Take the *bolt system* and insert it into the back of the *Etha body* (SEE FIGURE 18N). Using a 1/4" hex key, screw the *bolt system* into the *Etha body*.

The *bolt system* has now been lubricated and assembled.

¹DO NOT apply any grease or oil to the outside of the bolt guide, on any face of the rear bolt bumper and rear face and internal surfaces of the bolt.

⚠ WARNING //
IF YOU ARE AT ALL UNSURE OF PERFORMING A MAINTENANCE PROCEDURE PLEASE CONTACT YOUR NEAREST SERVICE CENTRE.



(CONTINUED)

To replace the *trigger*, tilt the *trigger* forwards inside the trigger guard and slide the *trigger* into the *frame* (SEE FIGURE 21E), making sure not to damage the *micro-switch*.

Align the trigger pin hole in the *trigger* with the trigger pin hole in the *frame* (SEE FIGURE 21F) then insert the *trigger pin* into the *frame*, making sure the *trigger pin* is centred in the *frame* (SEE FIGURE 21G). Using a 1/16" hex key tighten the *trigger pin retaining screw* to lock the *trigger pin* in place.

Replace the two *grip panels* and tighten the retaining screws into the *frame* using a 5/64" hex key (SEE FIGURE 21H).



QUICK GUIDE

CONTENTS
INTRODUCTION
QUICK SET-UP
ORIENTATION
USING THE ETHA
USER INTERFACE
MAINTENANCE
FAULT FINDING
PARTS LIST
SPARES & ACCESSORIES
INDEX

⚠ WARNING//
IF YOU ARE AT ALL UNSURE OF PERFORMING A
MAINTENANCE PROCEDURE PLEASE CONTACT
YOUR NEAREST SERVICE CENTRE.

(CONTINUED)

Check the front face of the *solenoid manifold* to ensure that it is also free from damage or debris (SEE FIGURE 22F).

Inspect and clean the *solenoid valve*, removing any moisture, dirt and debris, paying particular attention to the top sealing surface and exhaust ports (SEE FIGURE 22G).

DO NOT ATTEMPT TO DISASSEMBLE THE SOLENOID VALVE UNIT OR THE USER WARRANTY WILL BE VOIDED. IF THE SOLENOID IS DAMAGED IT WILL NEED TO BE REPLACED WITH A NEW UNIT.

Hold the *solenoid valve* onto the front face of the *solenoid manifold* ensuring the small *solenoid gasket* is still in place. Lining up the two screw holes, screw the *solenoid valve* retaining screws into the *solenoid manifold* (SEE FIGURE 22H)¹.

Hold the *solenoid manifold* onto the bottom of the *Etha body* taking care to line it up correctly with the screw holes in the *body* and to avoid pinching the *BBSS wires* underneath it. Use a 5/64" hex key to tighten the two screws that hold the *solenoid manifold* onto the *Etha body* (SEE FIGURE 22I)¹.

You have now successfully stripped and cleaned your *Etha solenoid assembly*.

¹DO NOT over tighten retaining screws, doing so may strip the threads or damage the part being retained.

⚠ WARNING //
IF YOU ARE AT ALL UNSURE OF PERFORMING A MAINTENANCE PROCEDURE PLEASE CONTACT YOUR NEAREST SERVICE CENTRE.



THE ETHA SOLENOID VALVE

The *Etha solenoid valve* (SEE FIGURE 23A) is **Non-Serviceable**. Any attempt to strip or service the *Etha solenoid valve* will immediately void your warranty.

If you experience any issue with your *Etha solenoid valve* then please contact your nearest Eclipse Service Centre for details on replacement *solenoid valves*.

See page 60 for Eclipse Service Centre details.

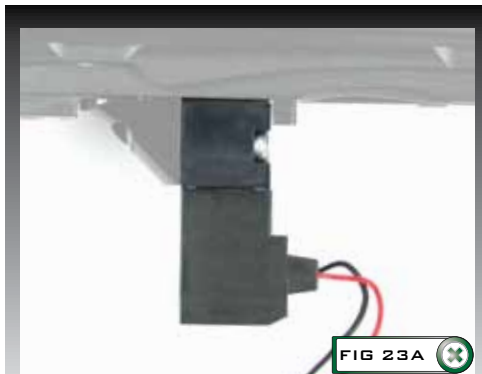

THE ON/OFF PURGE SYSTEM (OOPS)

⚠ WARNING //
DE-GAS YOUR MARKER, DISCHARGING ANY STORED GAS IN A SAFE DIRECTION, AND REMOVE THE BARREL, LOADER, AIR SYSTEM AND ANY PAINTBALLS TO MAKE THE MARKER EASIER AND SAFER TO WORK ON.

Having disconnected the *macroline* hose from the fitting on the *OOPS* body, unscrew and remove the *OOPS* knob from the *OOPS* body (SEE FIGURE 24A).

The *push rod* and o-rings will now be exposed (SEE FIGURE 24B). Carefully slide the *push rod* out from either side of the *OOPS* body, taking care not to lose the two o-rings on the *push rod* (SEE FIGURE 24C).

Clean off any dirt, debris or moisture from the *OOPS* knob and the *OOPS* body (SEE FIGURE 24D).

Remove the *OOPS* insert assembly using a 5/32" hex key (SEE FIGURE 25E). Remove the *OOPS* pin from the *OOPS* insert.

Clean and check the condition of the 007 NBR70 o-ring on the outside of the *OOPS* insert, replacing as necessary (SEE FIGURE 25F).



QUICK GUIDE

CONTENTS
INTRODUCTION
QUICK SET-UP
ORIENTATION
USING THE ETHA
USER INTERFACE
MAINTENANCE
FAULT FINDING
PARTS LIST
SPARES & ACCESSORIES
INDEX

(CONTINUED)

Clean and check the condition of the single internal 005 NBR90 o-ring in the front of the *OOPS insert* and replace if necessary (SEE FIGURE 24G). Lubricate this o-ring liberally using Eclipse Grease.

Lubricate the narrow end of the *OOPS pin* with a smear of Eclipse Grease and push the *OOPS pin*, narrow end first, into the *OOPS insert* so that it sits in the *OOPS insert* and pokes through to the front (SEE FIGURES 24H & 24I).

Screw the *OOPS insert* back into the *OOPS body* ensuring that the o-ring end goes in first.

Replace the *push rod* into its designated slot (SEE FIGURE 24J) then side 004 NBR70 o-rings onto both ends of the *push rod*. Make sure the *push rod* is centred in the *OOPS body* (SEE FIGURE 24K).

Slide the *OOPS knob* over the *OOPS body* and screw the *knob* onto the *body* (SEE FIGURE 24L).

Reconnect the *macroline* hose to the fitting on the *OOPS body* (SEE FIGURE 24M).

You have now successfully cleaned and maintained your *On/Off Purge System*.



⚠ WARNING ///
IF YOU ARE AT ALL UNSURE OF PERFORMING A
MAINTENANCE PROCEDURE PLEASE CONTACT
YOUR NEAREST SERVICE CENTRE.

SYMPTOM	POSSIBLE CAUSE	SOLUTION
Although a fresh battery has been fitted, the Etha will not switch on.	The battery terminals are not making proper contact with the battery.	Remove the battery, inspect the terminals for damage or debris and then replace the battery.
	The fly lead to the <i>Etha PCB</i> is damaged.	Replace the <i>Etha PCB</i> .
The battery does not seem to last very long.	The battery type is of a low quality.	Use an fresh 9V alkaline or lithium battery. Do not use a low quality or rechargeable battery.
The Etha leaks from the <i>solenoid</i> and/or <i>manifold</i> .	An <i>o-ring gasket</i> is damaged and/or not seated correctly in the <i>manifold</i> .	Replace the gasket if damaged using Etha parts kit. Ensure the gasket is seated correctly.
	The <i>solenoid valve</i> is not secure on the <i>manifold</i> .	Check the <i>solenoid</i> is secure on the <i>manifold</i> .
	Dirty / damaged <i>o-ring</i> on middle of <i>firing poppet</i> .	Clean / replace front <i>o-ring</i> with a new 010 NBR70 <i>o-ring</i> .
	Dirty / damaged middle <i>valve body o-ring</i> .	Clean / replace with a new 020 NBR70 <i>o-ring</i> .
	Dirty / damaged middle <i>valve joiner o-ring</i> .	Clean / replace with a new 014 NBR70 <i>o-ring</i> .
	The output pressure from the <i>inline regulator</i> is too high, triggering the <i>solenoid valve</i> built-in <i>pressure relief valve</i> .	Lower the output pressure of the <i>inline regulator</i> .
	Damaged <i>solenoid valve</i> .	Replace Etha <i>solenoid valve</i> .
The Etha leaks down the barrel.	Dirty / damaged <i>firing poppet assembly</i> .	Clean / replace <i>firing poppet</i> and front 010 NBR70 <i>o-ring</i> .
	Dirty / damaged <i>bolt guide</i> exhaust port.	Clean / replace <i>bolt guide</i> .
	Dirty / damaged <i>valve body</i> front <i>o-rings</i> .	Clean / replace 017 NBR70 and 020 NBR 70 <i>o-rings</i> .
Gas vents quickly down barrel as soon as the marker is gassed up.	Incorrect / damaged <i>o-ring</i> on front of <i>firing poppet</i> .	Replace front <i>o-ring</i> with a new 009 NBR70 <i>o-ring</i> .
Very poor efficiency.	The internal <i>o-ring</i> on the <i>valve joiner</i> is too small or damaged.	Replace <i>o-ring</i> with a new 012 NBR70 <i>o-ring</i> .
Low velocity.	The <i>Dwell</i> parameter is set too low.	Increase <i>Dwell</i> parameter.
	Poor barrel bore to paintball size match.	Use a barrel bore and paintball size that match.

SYMPTOM	POSSIBLE CAUSE	SOLUTION
The marker is chopping or trapping paint.	The <i>Break Beam Sensor System</i> is switched off.	Switch on the BBSS.
	The <i>bolt</i> is dirty, causing the BBSS to incorrectly detect a paintball.	Clean the <i>bolt</i> .
	The <i>BBSS</i> is dirty causing the incorrect detection of paintballs.	Clean the <i>BBSS</i> .
	The <i>Dwell</i> parameter is set too low.	Increase the <i>Dwell</i> parameter.
	The <i>firing poppet</i> tip o-ring is dirty / damaged.	Clean / replace o-ring as necessary.
	<i>Bolt tip</i> is damaged / not correctly seated.	Replace / re-seat rubber <i>bolt tip</i> .
The Etha does not fire.	The 9V battery is flat.	Replace with a fresh 9V alkaline battery.
	The front o-ring on the <i>firing poppet</i> is too big.	Replace o-ring with a new 010 NBR70 o-ring.
	The internal o-ring of <i>firing poppet</i> is too big.	Replace o-ring with a new 012 NBR70 o-ring.
	<i>Trigger</i> is set up incorrectly.	Set <i>trigger</i> correctly.
	<i>Solenoid wire</i> is not plugged into the Etha <i>PCB</i> .	Plug <i>solenoid wire</i> into socket on the Etha <i>PCB</i> .
	<i>Micro-switch</i> not plugged into Etha <i>PCB</i> .	Plug <i>micro-switch</i> into socket on Etha <i>PCB</i> .
	The <i>BBSS</i> is enabled but there is no paint.	Fill loader with paint.
	<i>Micro-switch</i> is being blocked by wires or debris.	Clear the path of the <i>micro-switch</i> .
	<i>Micro-switch</i> damaged.	Replace <i>micro-switch</i> .
	<i>Solenoid valve</i> is damaged.	Replace <i>solenoid valve</i> .
	Etha <i>PCB</i> is damaged.	Replace Etha <i>PCB</i> .
High velocity first shot.	<i>Inline regulator</i> output pressure is creeping.	Strip and clean the <i>inline regulator</i> replacing the <i>piston seal</i> if necessary.
The <i>trigger</i> is very "bouncy".	Incorrect Debounce settings.	Check that your <i>Debounce</i> settings suit your <i>trigger</i> set-up.
	<i>Trigger</i> pull too short and return strength too low.	Refer to Advanced Set-Up section for guidelines of how to adjust your Etha <i>trigger</i> accordingly.

SYMPTOM	POSSIBLE CAUSE	SOLUTION
The BBSS does not appear to be reading correctly.	The <i>Break Beam Sensor System</i> is dirty.	Keep the <i>Break Beam Sensors</i> clean to ensure correct readings (See Maintenance Section).
	<i>Break Beam Sensors</i> are the wrong way around.	Check that the red <i>sensor unit</i> is on the right-hand side of the breach.
The BBSS is not reading at all.	There is a broken wire or contact, or a short circuit on either of the sensor unit cables.	Check the connector on the BBSS cables. Check for cuts or pinches in the sensor cables.
	Either <i>sensor unit</i> is back to front.	Check that the <i>sensor units</i> face each other when installed.
Two or more balls are being fed into the breach.	Worn/Damaged <i>Detents</i> .	Replace the <i>Detents</i> .
	Feed force too high from loader.	Adjust loader settings/use lower force loader.
Etha is inconsistent.	<i>Inline regulator</i> is supercharging.	Strip and clean <i>inline regulator</i> .
	<i>Inline regulator</i> is dirty.	Strip and clean <i>inline regulator</i> .
	Dirty/Blocked <i>bolt stem</i> or <i>bolt guide</i> .	Clean <i>bolt</i> and <i>bolt guide</i>
	Poor barrel bore to paintball size match.	Use a barrel bore and paintball size that match.
BBSS turns itself off after firing.	<i>Sensor unit</i> is dirty.	Clean the BBSS.
	<i>Sensor unit</i> is faulty.	Replace the BBSS.
	<i>Sensor unit</i> is out of place.	Re-Install BBSS. Check alignment.
When the Etha powers up, the gun will not fire.	The <i>trigger</i> is permanently depressed.	Turn the front stop set screw in the top of the <i>trigger</i> counter-clockwise until the <i>micro-switch</i> can be heard clicking when <i>trigger</i> is pulled.
The Etha leaks out of the <i>body plug</i> in the front of the <i>body</i>	The o-ring on the <i>body plug</i> is dirty / damaged.	Replace o-ring with new 006 NBR70 o-ring.
<i>The Solenoid does not click</i>	Battery level is partially discharged.	Not an issue, the marker will continue to fire until the battery level is low.

The Fault Finding guide covers common symptoms, causes and solutions that are likely to be encountered by the average user. If an issue with the Etha cannot be solved using the Fault Finding guide, contact your nearest Eclipse Service Centre for assistance.

See page 60 for information on Eclipse Service Centre locations.

PARTS LIST

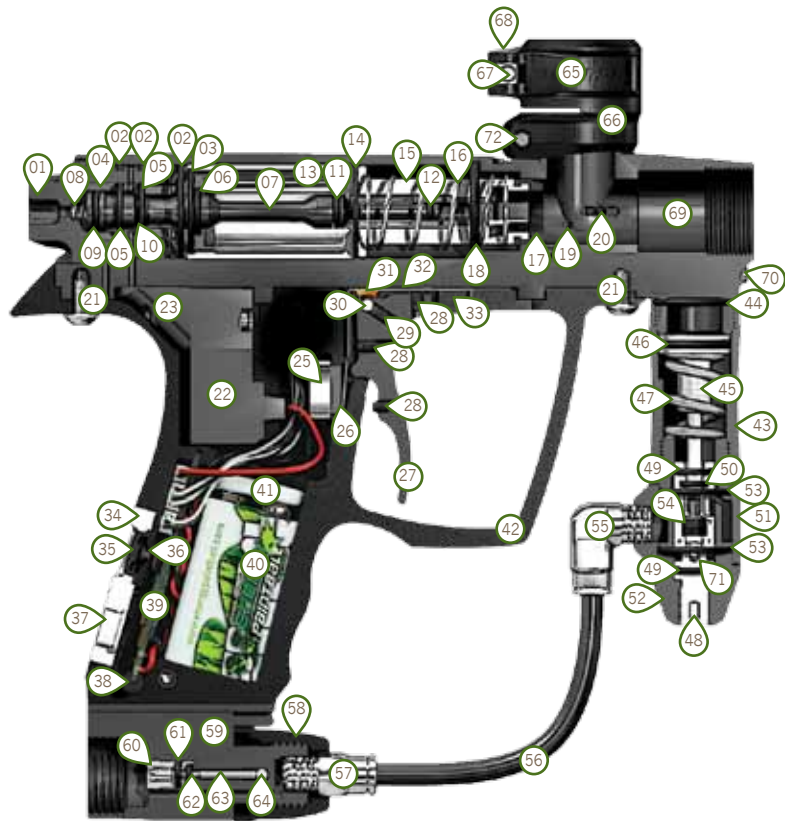

PART NAME

- | | | |
|---------------------------------|--|--------------------------------|
| 01 Valve Body | 29 Trigger Pin Locking Screw | 56 Macroline Hose |
| 02 Valve Body o-ring | 30 Trigger Pin | 57 Straight Macroline Fitting |
| 03 Valve Body Front o-ring | 31 Trigger Pin Brass Bushing | 58 OOPS Knob |
| 04 Valve Joiner | 32 Trigger Spring | 59 OOPS Body |
| 05 Valve Joiner External o-ring | 33 Trigger Spring Retaining Screw | 60 OOPS Insert |
| 06 Valve Joiner Internal o-ring | 34 Navigation Console | 61 OOPS Insert External o-ring |
| 07 Firing Poppet | 35 Select Button | 62 OOPS Insert Internal o-ring |
| 08 Poppet Spring | 36 Pushbutton | 63 OOPS Pin |
| 09 Firing Poppet Rear o-ring | 37 LED Lens | 64 OOPS Push Rod |
| 10 Firing Poppet Middle o-ring | 38 PCB Retaining Clip | 65 Clamping Lever |
| 11 Firing Poppet Front o-ring | 39 PCB | 66 Feed Neck |
| 12 Firing Poppet Tip o-ring | 40 9V Battery | 67 Long Feed Screw |
| 13 Bolt Guide | 41 9V Battery Connector | 68 Feed Swivel |
| 14 Bolt Bumper | 42 Frame | 69 Body |
| 15 Bolt | 43 Inline Regulator Top | 70 Body Plug |
| 16 Bolt Spring | 44 Inline Regulator Top o-ring | 71 Purge Poppet Assembly |
| 17 Bolt Tip | 45 Inline Regulator Piston | 72 Short Feed Screw |
| 18 Front Bumper | 46 Inline Regulator Piston o-ring | |
| 19 Break Beam Sensor Unit | 47 Inline Regulator Spring | |
| 20 Detent | 48 Inline Regulator Adjuster Assembly | |
| 21 Frame Screw | 49 Inline Regulator Adjuster o-ring | |
| 22 Solenoid Valve | 50 Inline Regulator Adjuster Internal o-ring | |
| 23 Solenoid Manifold | 51 Inline Regulator Swivel | |
| 25 Micro-switch Retaining Clip | 52 Inline Regulator Bottom | |
| 26 Micro-switch | 53 Inline Regulator Bottom o-ring | |
| 27 Trigger | 54 Inline Regulator Seal | |
| 28 Trigger Adjuster Screw | 55 90 Degree Macroline Fitting | |

QUICK GUIDE

CONTENTS

INTRODUCTION

QUICK SET-UP

ORIENTATION

USING THE ETHA

USER INTERFACE

MAINTENANCE











FAULT FINDING

PARTS LIST

SPARES & ACCESSORIES

INDEX

PARTS LIST

SCREW	QTY	DESCRIPTION
	2	MANIFOLD SCREWS (M2.5 x 5 CAP HEAD SOCKET)
	2	SOLENOID SCREWS (M3 x 17 BUTTON HEAD CROSS)
	4	GRIP SCREW (2), BBSS COVER SCREW (2) (6-32UNC x 5/16 COUNTERSUNK SOCKET)
	1	SHORT FEED NECK SCREW (10-32UNF x 1/2 CAP HEAD SOCKET)
	1	LONG FEED NECK SCREW (10-32UNF x 5/8 CAP HEAD SOCKET)
	1	TRIGGER SPRING RETAINING SCREW (SELF-TAPPING M2.0x6)
	1	TRIGGER SPRING ADJUSTMENT SCREW(1) (6-32 UNC x 3/16 SOCKET SET SCREW)
	3	TRIGGER ADJUSTMENT SCREW (2) TRIGGER PIN LOCKING SCREW(1) (6-32 UNC x 3/16 SOCKET SET SCREW)
	2	OOPS RETAINING SCREW (10-32 UNF x 1/2 SOCKET SET SCREW)
	2	FRONT AND REAR FRAME SCREW (10-32 UNF x 3/8 SOCKET BUTTON HEAD)
O-RING	LOCATION	
 <p data-bbox="257 961 299 988">020</p>	Valve Body (x3)	

CONTENTS

INTRODUCTION

QUICK SET-UP

ORIENTATION

USING THE ETHA

USER INTERFACE

MAINTENANCE















FAULT FINDING

PARTS LIST

SPARES & ACCESSORIES

INDEX

PARTS LIST

O-RING	LOCATION	O-RING	LOCATION
ALL O-RINGS ARE NBR 70 DUROMETER UNLESS OTHERWISE STATED.			
 18x2	Etha Body FRM	 012	Valve Joiner Internal
 017	Valve Body Front	 011	Firing Poppet Rear SL3 Inline Regulator Adjuster External (x2)
 016	SL3 Inline Regulator Piston SL3 Inline Regulator Bottom (x2) Shaft4 Barrel Back (body end)	 010	Firing Poppet Middle Manifold Front Port
 015	Shaft4 Barrel Back (tip end)	 009	Firing Poppet Front
 014	Valve Joiner External (x2)	 008	SL3 Inline Regulator Adjuster Internal
		 007	OOPS Insert External Manifold Rear Port
		 006	Body Plug
		 005	OOPS Insert Internal (NBR 90)
		 004	OOPS Push Rod (x2) Poppet Tip



ECLIPSE CERTIFIED SERVICE CENTRES

Are you unsure of where to send your Etha to be repaired or serviced? If your local Eclipse dealer can't assist you, why not contact your nearest Certified Eclipse Service Centre and arrange to send it into them to undertake any work that you require.

A map listing all of our Service Centres and their contact details can be found in the **SUPPORT** section of the Planet Eclipse web site at

www.planeteclipse.com/site/service_centres

FOR ANY TECHNICAL SUPPORT OR CUSTOMER SERVICE ENQUIRIES PLEASE ENSURE THAT YOU HAVE REGISTERED YOUR PRODUCT (WHERE APPLICABLE) USING THE WARRANTY CARD IN THIS MANUAL OR ONLINE PRIOR TO CONTACTING THE APPROPRIATE REPRESENTATIVE IN YOUR REGION.



CONTENTS
INTRODUCTION
QUICK SET-UP
ORIENTATION
USING THE ETHA
USER INTERFACE
MAINTENANCE
FAULT FINDING
PARTS LIST
SPARES & ACCESSORIES
INDEX

ECLIPSE GREASE

The recommended grease for use in all maintenance and servicing procedures that require grease.



ECLIPSE OIL

The recommended oil for use in all maintenance and servicing procedures that require oil.



ECLIPSE SHAFT4 BARREL KITS

A 2-piece Barrel Bore kit (includes .685 & .691 Barrel Backs) and a single 16" Barrel Front kit. COLOURS SUBJECT TO AVAILABILITY.



ETHA SERVICING & SPARES

Contact your nearest service centre for all your service and spares needs. See the interactive map at www.planeteclipse.com.

BALL DETENTS

Replacement Detents for your Etha.

ECLIPSE ETHA TOOL TUBE

This handy little tool tube includes all of the hex key sizes that you will need to strip and maintain your Etha.



- Air Systems.....22,23,27
- Auto-off timer...6
- Barrel 13,20,27-28,53
- Barrel bore...11,53,55
- Barrel back...13,20
- Barrel blocking device...20,22,27
- Barrel sock.....20,27
- Barrel threads...11,13
- Barrel tip...13,20
- Battery (9v)...9,12,18,30,53-54,56-57
- Battery connector...9,56-57
- Battery level indicator...30
- BBSS...6,7,18,20,30,32,34-35,54-55
- BBSS disabled...30
- BBSS enabled...30
- BBSS connector...6
- BBSS cover...12,34,35
- BBSS cover screw...12,34,35,58
- Body...12,56-57
- BBSS sensor unit...34-35,55,56-57
- Body plug...12,55,56-57
- Bolt...15,19,39,43,54,56-57
- Bolt guide...15,19,40-43,53,55,56-57
- Bolt stem...15,40,43,55
- Bolt bumper...15,40,56-57
- Bolt tip...15,39,54,56-57
- Bolt spring...15,19,39,43,56-57
- Bolt system...12,15,39-43
- Bounce...33,54
- Brass filer...16,48
- Capped semi...32
- Circuit board (PCB)...6,9,12,29,53-54,56-57
- Circuit board retaining clip...56-57
- Chopping...54
- Clamping lever...12,24,27,56-57
- Collet...21,36
- Contents....4-5
- Compressed air...22-23
- Debounce...33,54
- Detent...34-35,55,56-57
- Dwell...19,33,53,54
- Efficiency...53-54
- Factory settings...8
- Factory reset...33
- Feed neck...12,24,27,56-57
- Feed screw...24,27,56-57,58
- Feed swivel...56-57
- Filter....16
- Firing Mode Parameter...31-32
- Firing poppet...15,19,40-42,53,54,56-57
- Frame...9,12,44-45,56-57
- Frame screw...12,56-58
- Front bumper...56-57
- Grip panel...9,12,29,44-47
- Grip screw...12,58
- Inline regulator...8,12,14,19,21,23,26,36-37,55
- Inline regulator adjuster assembly...36-37,56-57
- Inline regulator adjuster top...14,38
- Inline regulator adjuster screw...8,14,26,36-38
- Inline regulator bottom...14,36-37,56-57
- Inline regulator piston...14,36-37,56-57
- Inline regulator top...14,36-37,56-57
- Inline regulator seal...14,38,56-57
- Inline regulator spring...14,36-37,56-57
- Inline regulator swivel...14,37,56-57
- Inline regulator
- LED...6,18,27,30
 - blue...31
 - green...30,31
 - light blue...7,30-31
 - purple...30,31
 - red...30-31
 - white...31
 - yellow...7,30
- LED lens...56-57
- Loader...24,54,55
- Macroline...12,21,36,37,56-57
- Macroline fitting (90 degree)...14,21,56-57
- Macroline fitting (straight)...17,21,56-57
- Manifold...12,16,48-49,53,56-57
- Manifold retaining screw...12,16,48-49,58
- Manifold o-ring gasket...16,48,53
- Maximum rate of fire...32
- Micro-switch...9,47,54,55,56-57
- Micro-switch connector...6
- Micro-switch retaining clip...56-57
- Millennium...11,32
- Mounting Screws....16
- Navigation console...6,7,18,30,33,56-57
- On/Off Purge System (OOPS)...12,17,20.

21,23,27,51-53
OOPS body...17,20,23,51-53,56-57
OOPS insert...17,51-53,56-57
OOPS knob...17,23,27,51-53,56-57
OOPS pin...17,51-53,56-57
OOPS push rod...17,51-53,56-57
OOPS retaining screw...17,20,58,56-57
Operational overview...19
Parameter....8,31
Pick.....39
Poppet spring...15,40-42,56-57
Power up...6
Preset air system...22-23
Pressure relief valve...53
PSP...11,32
Purge poppet assembly...14,38
Purge poppet spring...38
Purge poppet...38
Pushbutton...56-57
Rate of fire (ROF)...30
Select button...6,18,27,56-57
Set up mode...31
Shaft4...11,13,20
SL3 Inline Regulator Assembly....12,14,23,26,36-38
Solenoid assembly...12,16,19,48-50
Solenoid mounting screws...16,48,58
Solenoid valve...6,12,16,33,48-50,53,54,56-57
Solenoid valve connector...6
Storage...28
Supercharging...37-38,55
Tenths...31
Thread lock...21
Tournament lock...29,31
Tournament lock button...6,29
Tournament lock state...18
Transportation...28
Trigger...12,19,25,32,46-47,54,55,56-57
Trigger pin...46-47,56-57
Trigger pin brass bushing...56-57
Trigger pin retaining screw...46-47,56-57,58
Trigger screw (front stop)...25,56-57,58
Trigger screw (rear stop)...25,56-57,58
Trigger screw (return strength)...25,56-57,58
Trigger spring...9,25,56-57
T-slot...20

Uncapped semi...32
Units...31
Valve assembly...40-43
Valve body...15,40-42,53,56-57
Valve joiner...15,40-42,53,56-57
Velocity...26,53-54

QUICK GUIDE

CONTENTS
INTRODUCTION
QUICK SET-UP
ORIENTATION
USING THE ETHA
USER INTERFACE
MAINTENANCE
FAULT FINDING
PARTS LIST
SPARES & ACCESSORIES
INDEX

INDEX

U.S.A. , Canada & Americas

130 Franklin Street,
Building L4 & L5,
Warren, RI, 02885, USA
Call: +1 401 247 9061
Fax: +1 401 247 0931
info.usa@planetecclipse.com

Europe & Rest of World:

Unit 14 Premier Park, Acheson Way,
Trafford Park Road, Trafford Park,,
Manchester, M17 1GA, England
Call: +44(0) 161 872 5572
Fax: +44(0) 161 873 7536
info.europe@planetecclipse.com



Product covered and/or licensed under one or more of the following patents; G.B. 2,34,270; 2,345,953; 2,352,022; 2,391,292; 2,391,063;
U.S. 7,836,873; 12,511,619; 7,073,284; 11,280,011; 12,906,318; 7,509,953; 7,089,697; 11,930,431; 12,347,010; 6,311,682; 6,748,938; 6,860,259; 6,941,693; 7,073,284; 6,973,748;
5,881,707; 5,967,133; 6,035,843; 6,474,326; 6,637,421; 6,644,295; 6,810,871; 6,901,923; 7,121,272; 7,100,593; 7,610,908; 7,603,997; 7,946,285; 6,349,711; 7,044,119;
7,185,646; 7,461,646; 7,556,032; 7,591,262; 7,617,819; 7,617,820; 7,624,723; 7,640,925; 7,640,926; 7,866,308;
Application Nos. 12/256,832; 12/613,958; 12/493,777; 11/654,721; 11/747,107; 12/503,504; 11/781,821; 60/832,548; 11/965,886; 10/280,115; additional U.S. and
International Patents may be pending.

© Planet Eclipse Ltd 2011. Eclipse, the Estar Logo Device, Eclipse E-Portal, Ego, Etek, Etha and Geo are all either design trademarks, registered trademarks or
trademarks of Planet Eclipse Ltd.

All other design trademarks, registered trademarks or trademarks are property of their respective owner.