

# FREESTYLE 2004



**OPERATION  
MANUAL  
VERSION  
1.1**



## **RULES FOR SAFE MARKER HANDLING**

- 1. Treat every marker as if it were loaded.**
- 2. Never look down the barrel of a paintball marker.**
- 3. Keep your finger off the trigger until ready to shoot.**
- 4. Never point the marker at anything you don't wish to shoot.**
- 5. Keep the marker on safe until ready to shoot.**
- 6. Keep the barrel blocking device in/on the marker's muzzle when not shooting.**
- 7. Always remove paintballs and propellant source before disassembly.**
- 8. After removing propellant source, point marker in safe direction and discharge until marker is degassed.**
- 9. Store the marker unloaded and de-gassed in a secure place.**
- 10. Follow warnings listed on propellant source for handling and storage.**
- 11. Do not shoot at fragile objects such as windows.**
- 12. Every person within range must wear eye, face, and ear protection designed specifically to stop paintballs and meeting ASTM standard F1776.**
- 13. Always measure your marker's velocity before playing paintball and never shoot at velocities in excess of 91.44 meters (300 feet) per second.**

# FreeStyle Instruction Manual

## TABLE OF CONTENTS

Statement of Liability	4
Limited Warranty	5
FreeStyle Overview	6
Operation	7
Unloading the FreeStyle	9
Maintenance	9
Storage and Transportation	11
Adjusting the Trigger Pull	11
FreeStyle Tuning Guide	12
TROUBLESHOOTING	
Leak Related Problems	14
Ball Breakage Problems	15
Regulator Related Problems	15
Battery Related Problems	16
TECHNICAL DRAWINGS/ILLUSTRATIONS	
Tools Needed for Maintenance	18
Installing/Replacing the Battery	19
Field Stripping/General Maintenance	20
Adjusting your Regulators	21
Maintaining the Low Pressure Regulator	22
Cleaning your Ball Detention System	23
Maintaining your Valve	24
FreeStyle Schematic and Part Numbers	26
FreeStyle Exploded Schematic	27
WARRANTY REGISTRATION	28

# **INSTRUCTION MANUAL**

**Version 1.2**

**Indian Creek Design, Inc.**

**Model FREESTYLE**

**Copyright 1992.... 2004**

## **All Rights Reserved**

No part of this document may be copied or reproduced in any form or by any means without the prior written consent of **Indian Creek Design, Inc., its assigns and/or its distributors.**

Notice is hereby given that this manual is part of the article owned in whole by Indian Creek Design, Inc., its assigns and/or its distributors, known as indicated in this manual and drawings. All rights of manufacture and reproduction of such articles or any part thereof are reserved by Indian Creek Design, Inc., its assigns and/or its distributors. Neither said article nor any part thereof may be manufactured or reproduced except by written authorization from Indian Creek Design, Inc., its assigns and/or its distributors. All proprietary rights and information are the sole property of Indian Creek Design, Inc., its assigns and/or its distributors.

## **STATEMENT OF LIABILITY**

Indian Creek Design, Inc., delivers this marker with the understanding that **Indian Creek Design, Inc., its assigns and/or its distributors**, assumes no responsibility for its resale or safe handling. Serious injury or death may occur if mishandled, abused, or the safety instructions are ignored. **Indian Creek Design, Inc., its assigns and/or its distributors** assumes no responsibility for physical injury or property damage resulting from its use.

**Indian Creek Design, Inc., its assigns and/or its distributors**, makes no warranties with respect to this documentation and disclaims any implied warranties of merchantability or fitness for a particular purpose. The information in this document is subject to change without notice. **Indian Creek Design, Inc., its assigns and/or distributors** assumes no responsibility for any errors that may appear in this document.

## **WARNING:**

**This is not a toy. Misuse may cause serious injury or death. Eye protection designed specifically for paintball use must be worn by the user and any person within range. Recommend 18 years of age or older to purchase. Persons under 18 years of age must have adult supervision. Obey all local, state and federal laws. Follow the rules of safe paintball marker handling. READ OWNER'S MANUAL BEFORE USING.**

**INDIAN CREEK DESIGN, INC.  
LIMITED WARRANTY**

**Indian Creek Design, Inc.**, warrants the replacement of any original part due to defect in materials and/or workmanship of this marker. This warranty will be in effect for twelve (12) months for parts and twelve (12) months for labor following the original date of purchase for the original purchaser. Such warranty service will be provided only if the warranty registration card included with this manual is filled in completely and on file at **Indian Creek Design, Inc.** All other service will be duly charged for and returned via UPS C.O.D.

**Indian Creek Design, Inc.**, will replace without charge any original part that is determined by Indian Creek Design, Inc., to be defective under the terms of this warranty. However, shipping charges are not covered hereunder. Failure due to an accident, abuse, neglect, modification, normal wear, operator error, maintenance by other than an authorized **Indian Creek Design, Inc.**, dealer, or use of parts inconsistent with the use originally intended for the marker as sold, is not covered by this warranty.

There are no other warranties or guarantees, expressed or implied, made by **Indian Creek Design, Inc.**, on this marker. The sole and exclusive liability of **Indian Creek Design, Inc.**, and/or its authorized dealers, affiliates, or agents pursuant to this warranty will be for repair or replacement of the defective part; incidental or consequential damages are expressly excluded hereunder.

**Indian Creek Design, Inc.**, its authorized dealers, affiliates, or agents, will not be liable under this warranty, nor under any state or federal law, or the common law or otherwise for any damage or failure, including personal injury, resulting from such use and/or alteration. This warranty gives you specific legal rights, and you may also have other rights that may vary from state to state.

For warranty parts, service or information contact:

**Indian Creek Design, Inc.**  
**1019 First Street North**  
**Nampa, Idaho 83687**  
**(208) 468-0446**

## ***FREESTYLE* OVERVIEW**

The *FREESTYLE* is a quality marking instrument specially designed to meet the needs of the professional style tournament player. The *FREESTYLE* is an electronic solenoid actuated computer controlled marker. The major components of the *FREESTYLE* are machined from solid, aircraft-grade aluminum, and then hard anodized per military specifications. No castings are used in the construction of the *FREESTYLE*, thereby providing the end user with a high-quality, precision-engineered marker.

Paintball markers get a lot of abuse. Indian Creek Design, Inc., has built the *FREESTYLE* with this in mind. All internal parts, wear and contact surfaces have been heat treated or hard anodized. The toughest and most resilient materials and components have been used in the design of this product.

The *FREESTYLE* uses a single standard 9-volt battery for operation. The circuitry is a microprocessor based digital controller.

The *FREESTYLE* operates on low-pressure. The main operating pressure is 200-280 PSI nominally adjusted to visually via the gauge on the primary (input) regulator. The secondary pressure is factory pre-set and regulated to 85-95 PSI. Gas usage is controlled through these 2 internal regulators. A unique feature of this marker is the regulator adjustment. This allows precise adjustment for the velocity control of the marker and for optimal gas efficiency.

The *FREESTYLE* comes with a removable barrel system. This feature allows the user to select a barrel that is most suitable for the playing conditions. All barrels are honed with straight and spiral tip porting and stock length is 12".

## OPERATION

Read the entire manual before you prepare your *FREESTYLE* for play. Safety and safe marker handling are the most important aspects of paintball sports. Please practice each of the following steps with an **unloaded** marker before attempting to charge your marker with compressed air and paintballs. **Do not load compressed air and paintballs into your *FREESTYLE* until you feel completely confident with your ability to handle your *FREESTYLE* safely.**

Keep your finger out of the trigger guard and away from the trigger; point the muzzle of the marker in a safe direction at all times. Keep the marker turned off until ready to operate. The *FREESTYLE* uses an on-off switch for one of its safety devices. ***Always keep your *FREESTYLE* pointed in a safe direction. Always use a barrel plug or barrel blocking device. Remember that the ultimate safety device is you, the operator.***

### Installing the 9 volt Power Source

The *FREESTYLE* requires a single 9-volt battery as the electronic power source. The use of long life batteries is recommended.

The 9-volt battery is located in the grip behind the trigger and below the on-off switch. The battery is accessed through the grip panel located on the left side of the marker.

Remove the 2 screws that hold the grip panel in place. Connect the battery to the terminal and place the battery inside the frame carefully being sure that the black and red wires to the terminal are toward the top. Make sure that there are no abrupt kinks and the wires are comfortably placed, do not force them into place. Replace the grip panel and 2 screws.

### Compressed Air usage

The *FREESTYLE* comes with a female ¼" Push-In fitting adapter on the input of the regulator. The *FREESTYLE* can be set up to use a nitrogen or compressed air system. Although it may be used, CO<sub>2</sub> is not recommended for use as the propellant. Generally the CO<sub>2</sub> that we use as an industry is industrial grade CO<sub>2</sub>. It is dirty, pumped from large tanks full of contaminants including dirt, rust and metal flakes. CO<sub>2</sub> can be used most successfully if used with anti-siphon systems and filters. Be aware that under the conditions of CO<sub>2</sub> the results may not be as expected. Consult the place where you purchased your *FREESTYLE*, or a recognized and competent airsmith, for instruction in the safe handling of compressed-air cylinders before purchasing or connecting one to your *FREESTYLE*.

### Adjustable regulator compressed air systems:

The input pressure from your compressed air system should be regulated down to 350-500 PSI output pressure. Use a VERY HIGH FLOW low pressure output tank and regulator set-up for your best results. The *FREESTYLE* will work just fine with a pre-set regulated tank or an

adjustable output regulated tank. Note: on MOST systems, there is a large difference between the setting pressure and the actual output operating pressure. If your compressed air system does not have an output pressure gauge on its regulator we do not recommend its use.

### **Fixed output regulated compressed air systems:**

The FREESTYLE will work just fine with a pre-set tank. Although, you will get much better performance from a HIGH FLOW low output pressure tank/regulator than with a high pressure (750-850) output. VERIFY the output pressure from the regulator. If your compressed air system does not have an output pressure gauge on its regulator we do not recommend its use.

### **CO2 usage:**

Although it may be used, CO2 is *not* recommended for use as the propellant. Generally the CO2 that we use as an industry is industrial grade CO2. It is dirty, pumped from large tanks full of contaminants including rust and metal flakes. CO2 can be used most successfully if used with anti-siphon systems and filters. Be aware that the use of CO2 may result in less than optimal performance. CO2 use is NOT covered under warranty.

**REMEMBER:** CO2, compressed air or nitrogen systems can be extremely dangerous if misused or improperly handled. Use only cylinders meeting D.O.T. specifications. Do not perform any work to your tank or tank regulator. NEVER disassemble your tank or tank regulator. Only a qualified and trained technician should perform work to your tank and tank regulator.

Before pressurizing your *FREESTYLE*, check to make sure that you and anyone within range are wearing eye protection designed specifically for paintball. Be sure you have a barrel plug sock or barrel blocking device in place and there are no paintballs in the marker. The on-off switch should be OFF. Air can now be applied, the marker will become pressurized and the bolt will slide backwards.

### **Paintball and Loader Usage**

The *FREESTYLE* comes equipped to accept 1.03" OD standard-gravity feed loaders. Fit the loader directly into the vertical feed tube. Always twist it down in a CLOCKWISE direction. Always twist it off in a CLOCKWISE direction as well. The *FREESTYLE* uses .68 caliber, water-soluble paintballs. The paintballs are gravity fed from the loader through the direct vertical feed nipple and into the breech of the marker. A collet clamping type feed tube will aid in keeping you loader held in place.

### **Modes - Rate of Fire –**

The 2004 FREESTYLE features a single mode of fire.

1. The FREESTYLE is set for Semi-auto or single shot per trigger pull mode only.



2. The cycle rate is set extremely fast.

### Firing the *FREESTYLE*

Keep your finger out of the trigger guard and away from the trigger; point the muzzle of your marker in a safe direction at all times during this process. Be sure your goggles are securely in place. Push the on-off toggle switch into the off position.

***Always keep your FREESTYLE pointed in a safe direction!***

1. Place the empty loader onto the marker. Be sure that it is securely mounted in place.
2. Apply the compressed gas, pressurizing the marker.
3. Put the paintballs into the loader.
4. Remove the barrel plug, sock or barrel blocking device.
5. Aim the marker at the target.
6. Push the on-off toggle switch to the ON position, the LED will light up.
7. Place your finger on the trigger.
8. Pull the trigger with a smooth squeezing motion. **BANG. . . .**

### UNLOADING THE *FREESTYLE*

Keep your finger out of the trigger guard and away from the trigger; point the muzzle of your marker in a safe direction during this entire process. ***Always keep your FREESTYLE pointed in a safe direction!***

1. Push the on-off switch to the off position. The LED will be off.
2. Place the barrel plug, sock or barrel blocking device into the end of the barrel.
3. Remove the pressurized gas from the marker carefully.
4. Tilt the marker so that the loader is lower than the body of the marker.
5. Remove the paintball loader from the direct vertical-feed tube, turning the loader in a clockwise direction.
6. Inspect the inside of the direct vertical-feed tube to be sure that a ball does not remain inside the breech.
7. Remove the barrel and make sure there is no ball in the barrel and double-check the breach area for the presence of a paintball.
8. Remove and discard any paintballs that are found in the barrel or breach.

### MAINTENANCE

**CAUTION:** Before attempting to perform any maintenance operations or any marker disassembly, make sure that ***all*** paintballs and propellant sources have been removed from the marker. Install a barrel blocking device, push the on-off toggle switch to the OFF position and keep the marker in this "SAFE" mode.

## Simple Maintenance

Keep your *FREESTYLE* clean and lubricated to eliminate the friction that would prevent reliable operation. Clean and lube the marker before each use, and do not put it away dirty. USE NO OILS! Do not use oils made for paintball markers, real firearms or pneumatic tools, do not use oils at all. Do *not* use petroleum-based lubricants in the lubrication of this marker. Teflon or silicon spray lubricants may be used for lubrication for the bolt area only of the main housing. Lithium grease such as Dow 33 is recommended for lubricating the regulator pistons, and the cylinder assembly. Be sure it is Lithium Grease and not axel grease.

### Cleaning Paint from the Barrel

Unscrew the barrel to remove the barrel for swabbing/cleaning. Keep the barrel clean to insure the continued accuracy of the *FREESTYLE*. Gelatin from the paintballs has a tendency to build up in the barrel. As part of your cleaning ritual, wash out the barrel with hot soapy water and rinse it well.

### PDS (paintball detection system)

The PDS (paintball detection system) is designed to detect whether or not a paintball is seated in the breach ready to fire. *If a paintball is not there, it will not cycle.* An on/off toggle switch has been provided for the PDS for the instance of dry firing and simply over-riding the PDS. The toggle switch is located next to the on-off toggle switch. When placed in the upward position the red light will remain off until it detects a paintball in the breach. Keep the infrared emitters and detectors clean for your best results.

### Removing the Bolt/Cylinder Assembly (Field Stripping)

Remove the paintballs and pressurized gas from the marker. *The marker cannot be field stripped while it is pressurized.*

1. Remove the 10-32 button head screw from the rear of the grip frame directly above the on-off toggles. Pull the body section out the back of the main body and grip frame.

Once the bolt assembly is removed, it is possible to clean the entire upper receiver of the marker, including the breach and feed tube area. You may slightly lubricate the rear section of the cylinder chamber with a Lithium grease lubricant before re-installing the bolt/cylinder assembly. Do *not* use petroleum/oil-based lubricants. The bolt tip is *NOT* a simple plastic; it is a natural Delrin acetate material, which is a Dupont 3M material, developed specifically for this type of application. *The use of a metal tipped bolt will void all warranties.*

1. Point the barrel downward and slide the bolt/cylinder assembly in until the 10-32 button head screw hole lines up with the screw hole in the grip frame and the body sections are

flush to each other. Carefully install the 10-32 button head screw.

## **STORAGE AND TRANSPORTATION**

- Your *FREESTYLE* must be clear of all paint and propellant when not being used.
- Be sure the on-off switch is off and the LED is not lighted.
- Put the barrel blocking device in its place.
- Make sure the marker is clean.
- Store your *FREESTYLE* in a clean, cool, dry place.
- Keep your *FREESTYLE* away from unauthorized users.

***This is not a toy. Misuse may cause serious injury or death. Eye Protection designed specifically for paintball must be worn by the user and persons within range. Recommend 18 years of age or older to purchase. Persons under 18 years of age must have adult supervision.***

Your *FREESTYLE* must be clear of all paint and any source of propellant during transportation to and from the playing field. Keep your barrel blocking device in place. Keep the on-off switch in the off position. Protect your *FREESTYLE* from excessive heat during transportation. Observe and obey all local, state and federal laws concerning the transportation of paintball markers. For information concerning any of the laws in your area, contact your nearby law enforcement agency.

**IMPORTANT: Never carry your *FREESTYLE* uncased when not on a playing field. The non-playing public and law enforcement personnel may not be able to distinguish between a paintball marker and firearm. For your own safety and to protect the image of the sport, always carry your *FREESTYLE* in a suitable marker case or in the box in which it was shipped.**

If you must ship your *FREESTYLE* for any reason, the box in which you purchased the marker is acceptable to all major carriers. Never ship charged CO2 or pressurized gas cylinders.

## **ADJUSTING THE TRIGGER PULL**

You will notice three (3) screws in your trigger. These screws adjust the length of pull, actuation point and spring tension of the trigger. The bottom screw adjusts your trigger stop point (length of pull). The middle screw is the contact point for your micro switch or actuation point. The top screw is the spring tension adjustment screw.

1. Use *blue loctite* while adjusting the screws. Normal activity can cause the screws to back out of adjustment. **DO NOT** glob the loctite on, it can cause damage to the micro switch if you use too much.

2. Begin by adjusting the bottom screw to your desired pull. Screw it in to lessen the distance the trigger must travel.
3. *Very Carefully* screw in the middle screw. Making large adjustments can force the screw into the micro switch and damage it. You will want to screw it in to the point where it makes contact with the micro switch but does not permanently rest on it. Continually check to verify that the LED flashes off and then back on when you pull the trigger. If you pull the trigger and the LED goes off and *stays off*, you have adjusted the screw in too far. Back it out.
4. Adjust the spring tension by turning the top screw in for more tension and out for less tension.
5. Clean up any excess loctite and let it dry for at least an hour before using your *FREESTYLE*. This ensures the screws will remain in place.

### ***FREESTYLE TUNING GUIDE***

The *FREESTYLE* has a totally new and innovative system. This marker is unlike any other system you may be familiar with. Take a few moments and read thru this next section and understand how this system works.

The low pressure regulator in this marker is used only to move and hold the bolt/cylinder assembly in the rearward position for the loading of the ball thru the de-activation of the solenoid. When the solenoid is activated via a pull of the trigger, the solenoid valve shuts off the low pressure air to the cylinder and vents the air from the cylinder to atmosphere. The higher pressure air (220-280 psi) then pushes the bolt/piston to the forward position and the higher pressure air then vents thru the front of the bolt to shoot the paintball. The solenoid valve is then de-activated (the current is shut-off) and the low pressure air from the low pressure regulator is then directed thru the solenoid valve to the bolt/cylinder assembly and forces the bolt backwards to allow another ball to be loaded and wait for another trigger activation. Since the low pressure air system is holding back the high pressure air system it is imperative that the low pressure system be tuned correctly. If the low pressure system is adjusted too weak the bolt/piston will blow forward or will not re-cock completely. If the low pressure system is adjusted too high then the bolt/piston may not move far enough forward to shoot correctly or may not move at all when fired or may blow forward and leak thru the relief valve in the solenoid valve. The low pressure regulator is your fine tune adjustment on your choice of velocities. Once you set your main input regulator to approximately 260 psi on the gauge on the marker, then place the low pressure adjustment screw wrench into the front of the low pressure regulator. To increase your velocity you would *decrease* the pressure from your low pressure regulator making sure the bolt returns completely each time. To decrease your velocity you would *increase* the pressure from

your low pressure regulator.

### **High pressure regulator adjustment:**

The pressurized gas from your regulated tank is fed to the main input regulator on the front of the marker. The main pressure regulator is externally adjustable via the screw in the bottom of the high-pressure regulator. To increase the pressure use a 5/32" allen wrench inserted into the screw and turn clockwise.

**NOTE: Only slight turns** are needed to accomplish changes in the pressure used to shoot the paintball.

To decrease the pressure shown on the gauge, turn the screw counter-clockwise. You must take a clearing shot before the change in the decreasing direction can be registered.

A pressure gauge has been installed into the regulator body to indicate the exact operating pressure of the marker. This gauge is extremely useful. At the factory we set the regulator gauge to 220-280 PSI with an input pressure of 400 PSI using Compressed air as the base propellant. Under normal circumstances these settings will produce paintball velocities at approximately 280-300 fps. The input pressure from your tank should be set at 350-500 PSI. Higher input pressures will not provide increased performance. There is a specific input side and output side of the main input regulator. If the gauge and input sides are switched, the outcome will be total bypassing of the main input regulator.

### **Low pressure regulator adjustment (Velocity adjustment):**

The low pressure regulator is externally adjustable via the adjustment screw in the front of the low-pressure regulator. The low pressure regulator is pre-set at the factory to 85-95 PSI to operate the 4-way solenoid actuated valve that is used as a 3 way for this application. It may be necessary to re-adjust the low pressure regulator from time to time to achieve desired velocities. Bench adjusting the regulator can be done by pressurizing the marker, be sure the input regulator is set properly, and then turning the adjustment screw inward (clock-wise) until you hear a leak coming from the 4-way valve in the grip area. The 4-way valve has an over-pressurization relief valve that will start to bleed off at approximately 125 PSI, once you hear the leak start then back off the adjustment screw one turn and the leak will stop. That will approximate the pressure to about 90 PSI. The low pressure regulator is designed to shut down and preserve the integrity of the low pressure system if it sees an input pressure over approximately 400 PSI coming from the main input regulator.

This marker was designed with safety and safety standards in mind. If you attempt to shoot paintballs higher than established safety standards, the marker may not function properly.

**NOTE 1. If you attempt to operate the marker at extremely high velocities, the internals will not function properly!**

**NOTE 2. This gun is not designed to shoot above the safety limits established by industry standards but under certain conditions it may. It is therefore important to check**

**the velocity each time before playing with your FREESTYLE.**

## Leak Related Problems

**The *FREESTYLE* has a leak down the barrel.**

**There could be two reasons:**

**1. gas is leaking through or around the valve pin o-ring seal or**

- a. Can you hear the leak when the gas is removed? Yes? There is no leak. You hear the ocean.
- b. The valve seal o-ring is marred/scratched or worn out or dirt has gotten to it. Replace it. Sized 010 90 duro urethane.
- c. The valve seal slide has on o-ring sealing the slide in the housing. Replace it. Sized 011 70 duro nitrile.

**2. the cylinder O ring area.**

- a. The cylinder o-rings may have deteriorated and need to be replaced. The outside o-rings are sized 020.

**2. The *FREESTYLE* has a leak around the high-pressure regulator seam. Reason: the seal between the regulator body and the main body is bad.**

- a. Tighten the regulator to the body.
- b. Check and/or replace the O ring.

**3. The *FREESTYLE* has a leak around the low-pressure regulator seam. Reason: the seal between the regulator body and main body is bad or the regulator has loosened up.**

- a. Tighten the regulator into the body.
- b. Check and/or replace the O ring gasket. Sized -019.

**4. The *FREESTYLE* has a leak inside the grip/battery area. Reason: the 4-way valve is leaking.**

- a. Tighten the 4-way valve to the manifold. Take care not to over-tighten.
- b. Check for over-pressurization from the low-pressure regulator. Re-adjust the low-pressure regulator.

- c. Replace the O-rings on the cylinder assembly. Sized -015.
- d. Replace the piston O-ring. Sized -011
- e. Replace the solenoid/valve assembly.

## Ball Breakage Problems

### 1. The ball breaks in the breech.

- a. The balls in your loader can bind, messing up your trigger timing. Note the ball drop and use an agitated loader.
- b. As you run and shoot, you actually unweigh the gravity-fed balls in your loader. This can cause a ball to hesitate in its drop. This affects your trigger timing.
- c. If the ball retention O-rings do not move freely, the paintballs will crush against it or it may have stuck in the depressed position allowing double feeding. Check their tension regularly and keep this area as clean as possible.
- d. If the ball retention O-rings are too sloppy, the ball will not be held in the proper position. This may allow the next ball to enter the path of the bolt, subjecting it to impact cracking or shearing. Verify the tension of the O-rings.

## Regulator Related Problems

### 1. The gauge reads correctly when charged, but climbs in pressure after a few moments.

- a. The regulator seal has been contaminated. Disassemble the regulator, and clean the seal with a Q-tip and alcohol. If you need assistance in the disassembly of the regulator, please call (208) 468-0446.

### 2. The gauge reads correctly when charged, but drops in pressure after a few shots.

- a. The regulator may not be adjusted correctly. Remove all pressurized gas, and back off the regulator adjustment screw 3 turns. Pressurize the system and adjust the pressure back up to the desired pressure.
- b. Slow regulator recovery can be directly related to the recovery time of the tank regulator. All compressed air tank regulators are not created equally, some may perform and some

may not.

c. If you use a bottom-line adaptor with an on/off valve, verify you are completely opening the valve on the on/off. Only partially opening of the valve will cause sluggish recharge recovery and/or velocity problems.

### **3. The gauge reads correctly when charged, but drops in pressure after a few shots, and is slow to climb back to normal pressure.**

d. The recovery side of the regulator is sluggish and may need cleaning and lubrication. If you need assistance in the disassembly of the regulator, please call (208) 468-0446.

e. The regulator seal needs to be replaced if it has a deep groove in it from the regulator cup.

f. Slow regulator recovery can be directly related to the recovery time of the tank regulator. All compressed air tank regulators are not created equally, some may perform and some may not.

d. If you use a bottom-line adaptor with an on/off valve, verify you are completely opening the valve on the on/off. Only partially opening of the valve will cause sluggish recharge recovery and/or velocity problems.

Replacing or removing the original regulators voids all warranties.

## Battery Related Problems

**1. LED functions but the marker does not fire.**

**2. Alternately missed shots.**

**3. Velocity drops while firing several shots.**

**4. Erratic Velocities. Jumps of 20 fps or more.**

**5. Unexplainable paint breakage.**

**6. Slight leak from the solenoid in the back of the grip.**

a. Change the battery. The LED only requires 1½ volts to function. The solenoid requires



a minimum of 5 volts to operate. This means the marker may appear to be getting enough power when it is not. All batteries are NOT created equal. Performance will vary.  
*Therefore, if you experience any erratic behavior, always change the battery first.*

**NOTES:**

## Tools needed for maintenance

The tools needed for assembling and maintaining are:

- 5/32" allen wrench (provided)
- 1/8" allen wrench (provided)
- 7/32" allen wrench (provided)
- 3/32" allen wrench (provided)
- 5/64" allen wrench (provided)
- Phillips screw driver size "00"

Cleaning solutions:

Rubbing alcohol and Q Tips

Lubrication:

Dow 33, or equivalent Lithium Grease



## Installing/Replacing the Battery

Using the 5/64" allen wrench provided in your kit, remove the two 6-32 button head screws that hold the grip panel in place on the left side of the gun. Fold the panel back as shown to allow free access to the battery compartment. Be careful not to pull the wires to the battery terminal too hard or too far out of the compartment, you may damage the connection of the wire harness. Damage done because of pulled wires in this manner is not covered under warranty. Snap the battery into the battery clip and place the battery and clip into the battery compartment being careful not to pinch or crimp the wires. Place the grip panel back into place and replace the 6-32 button head screws.



## Field stripping/ General maintenance

Field stripping cannot be done while the FreeStyle is pressurized. Remove the air system from the gun to be sure there is no air in the gun. Using a 1/8" allen wrench, remove the 10-32 button head screw from the back of the body as shown in the first photo. Once the 10-32 button head screw is removed then slide the rear body straight out the back of the gun as shown in the second photo. This will allow a straight view out thru the front of the gun.

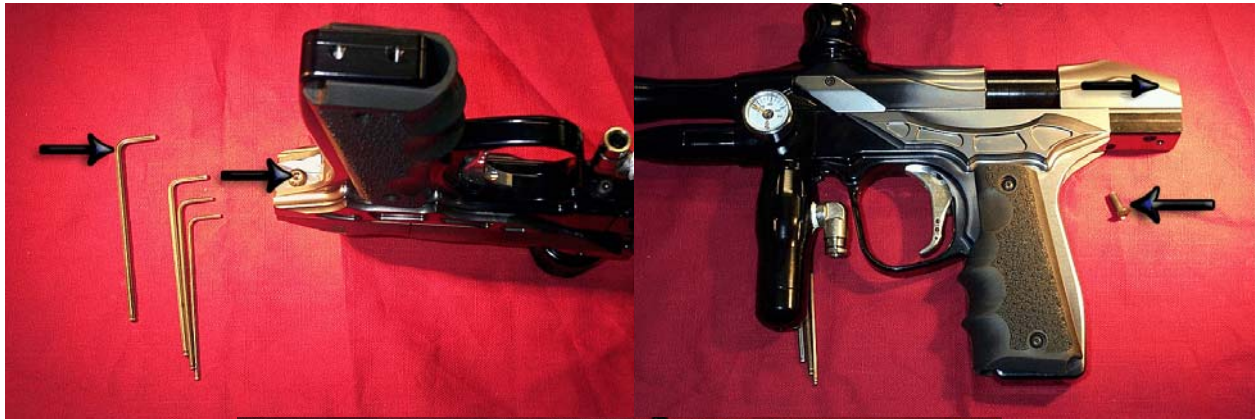

## Adjusting your Regulators

Your High Pressure Regulator determines the pressure of air that is used to propel a paintball from the breech, and the resultant velocity of that paintball. Using a 5/32 allen wrench, adjust the high pressure regulator via the screw in the bottom of the regulator. Turning clockwise will increase the pressure and turning counter-clockwise will decrease the pressure. Make small adjustments of a 1/4 turn to 1/2 turn at a time. The pressure reading is visible on the gauge provided. Adjust the high pressure regulator between 220-280 p.s.i. Always adjust your high pressure regulator before adjusting your low pressure regulator. **Observe all safety precautions while adjusting the regulator. You and anyone within range must wear paintball-approved goggles and shoot only in a safe direction when chronographing your marker. If you are dry-testing your marker, verify that there are no paintballs in the breech and point your marker in a safe direction.**

Your Low Pressure Regulator determines the pressure of air that is used to recock the cylinder/bolt and for fine-tuning your velocity. Using a 3/32 allen wrench, adjust the low pressure regulator via the screw in the front of the regulator cap. Turning clockwise will increase the pressure and turning counter-clockwise will decrease the pressure. Make small adjustments of a 1/4 to 1/2 turn at a time. Shoot between adjustments to gauge proper functioning of the marker. If the bolt seems sticky or shots are weak, the pressure is too high. If the bolt does not cock all the way back or there is a leak down the barrel, the pressure is too low. The pressure used should be between 50 to 80 p.s.i. The solenoid valve will bleed off, causing a leak from the interior of the marker if pressurized over 125 p.s.i.



## Maintaining the Low Pressure Regulator

Removing the low pressure regulator cannot be done while the FreeStyle is pressurized. Remove the air system from the gun to be sure there is no air in the gun. Unscrew the entire low pressure regulator from the front of the marker, being careful not to drop or lose the internals from the front of the regulator.

The regulator must be cleaned and lubricated on a regular basis. Clean all parts and then lubricate the regulator piston size -15 urethane o-ring with Dow 33 lithium grease. Using a q-tip and rubbing alcohol, clean the regulator seal and flip or replace it if there are any mars, scratches, or dents.

Notice the regulator cup is inserted into the top of the regulator with the cup portion facing the regulator seal and the guide section facing the spring, with the spring inserted over the guide. Notice also the steel pin of the regulator piston faces the regulator cup. **Improper assembly and/or failure to assemble all parts within the regulator will result in improper function of the regulator. If you do not feel comfortable disassembling and reassembling the regulator, take your marker to an authorized technician or call (208) 468-0446. Improper reassembly and damage created from it are not covered under warranty.**

The low pressure regulator must be re-adjusted after disassembly.

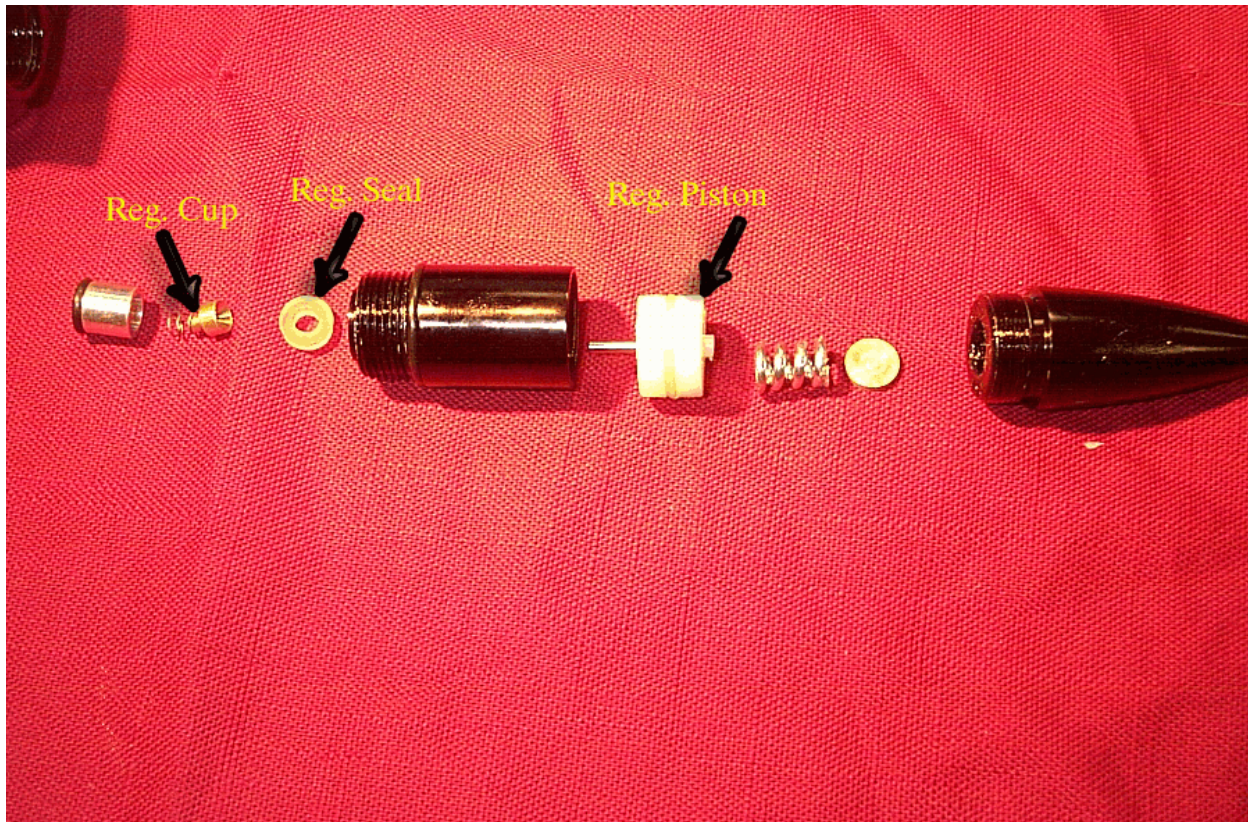

## Cleaning your Ball Detention System

Very carefully remove the eye cover on the side of your marker using a 3/32 wrench. Set the eye cover aside. You now have access to the PDS sensors and ball detents. The ball detent consists of a spring and a semicircle delrin piece. Remove both and clean with q-tips and rubbing alcohol. Reinstall by inserting the semi-circle piece sphere down into the hole and placing the spring behind it. The PDS sensors may be cleaned if needed. Be careful not to pull or pinch any wires while cleaning or reinstalling the eye cover. **Pulling and/or pinching your wires is not covered under warranty.**



## Maintaining your Valve

**REMEMBER!** The rear main body **MAY NOT** be removed from the back of the marker **when the marker is pressurized!** When the rear main body is removed the cylinder assembly becomes visible, as shown in the far left picture. The black cylinder body may be unscrewed from the back receiver. The valve housing rests underneath, as shown in the second picture. The white valve housing tip may be unscrewed to be cleaned or for o-ring replacement. The valve pin is screwed into the piston, and may be unscrewed for cleaning or o-ring replacement. Use only URETHANE 90 o-rings for the piston, valve pin, and interior of the cylinder assembly.

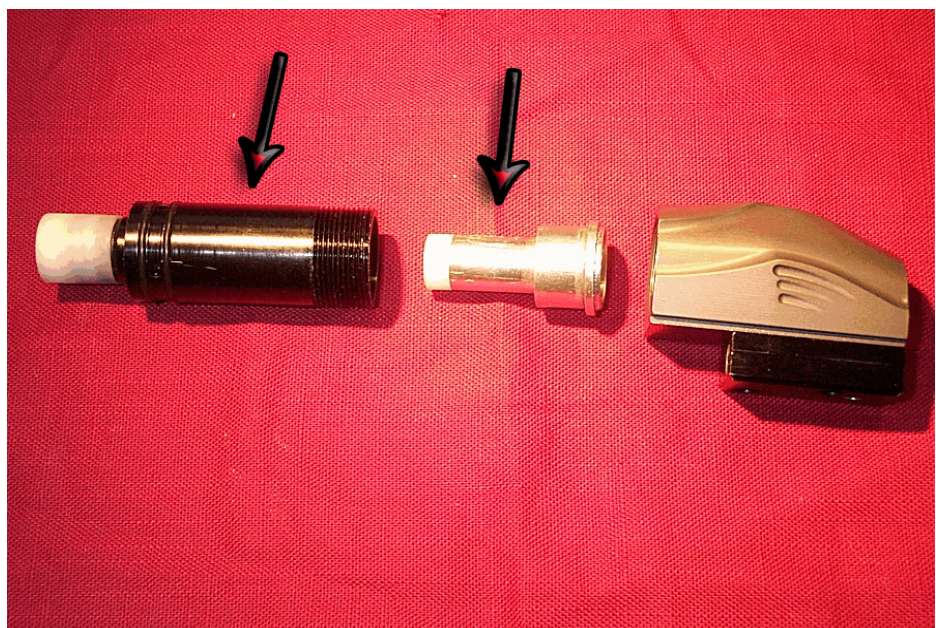



## Maintaining your Valve

**REMEMBER! The rear main body MAY NOT be removed from the back of the marker when the marker is pressurized!**

When investigating a leak down the barrel, there are four primary areas to check:

1. The size -006 urethane o-ring on the valve tip. If the o-ring is worn, dented, or scratched, replace it.
2. The front -020 buna o-ring on the outside diameter of the cylinder.
3. The interior -017 urethane o-ring in the cylinder. Always try re-adjusting your low pressure regulator first. If your low-pressure regulator is over-pressurized, air will leak past this o-ring and down the barrel.
4. The size -017 urethane o-ring on the lip of the piston. This leak will sound like it is coming through the bolt tip.

**Remember to keep these o-rings lubricated properly with Dow 33 Clear Lithium Grease. Improper assembly and/or failure to assemble all parts within the valve will result in improper function of the valve. Improper reassembly and damage created from it are not covered under warranty. If you do not feel comfortable disassembling and reassembling the valve, take your marker to an authorized technician or call (208) 468-0446.**

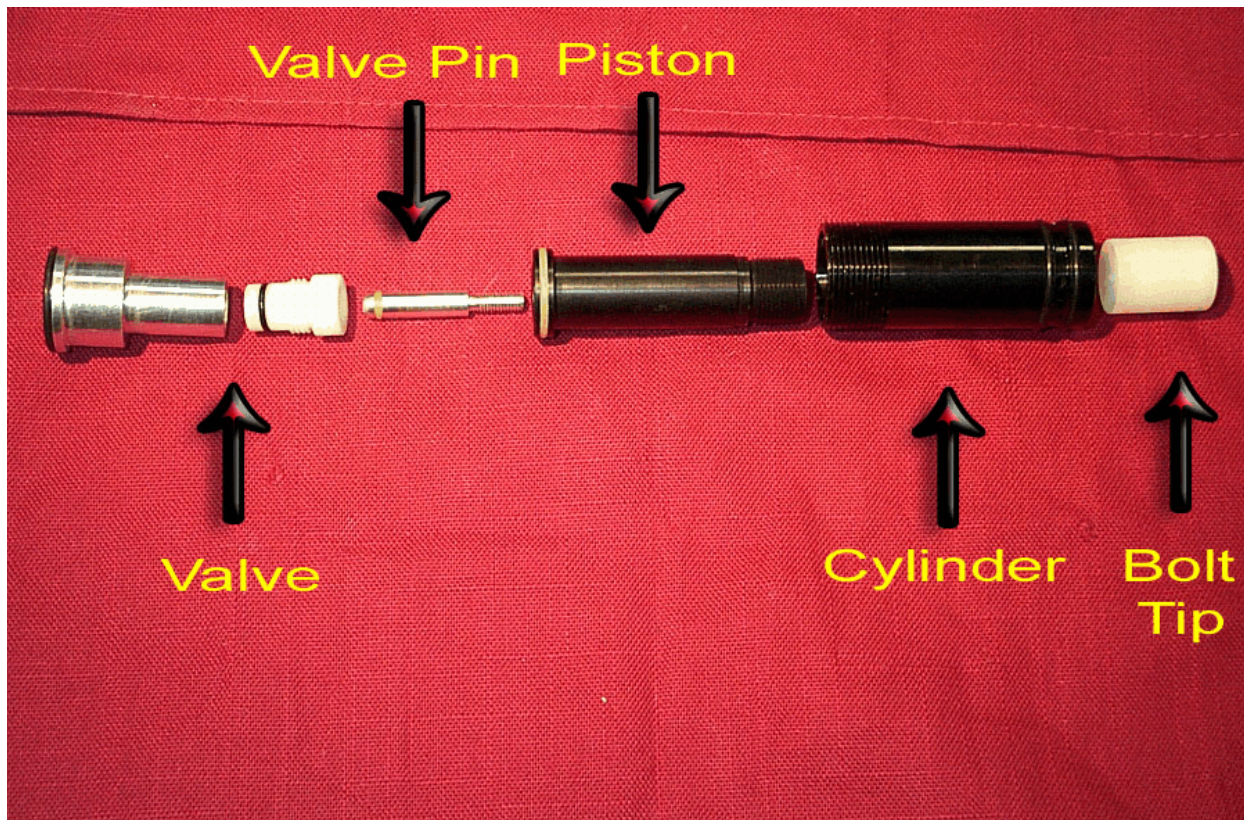

# 2004 FreeStyle™ Marker

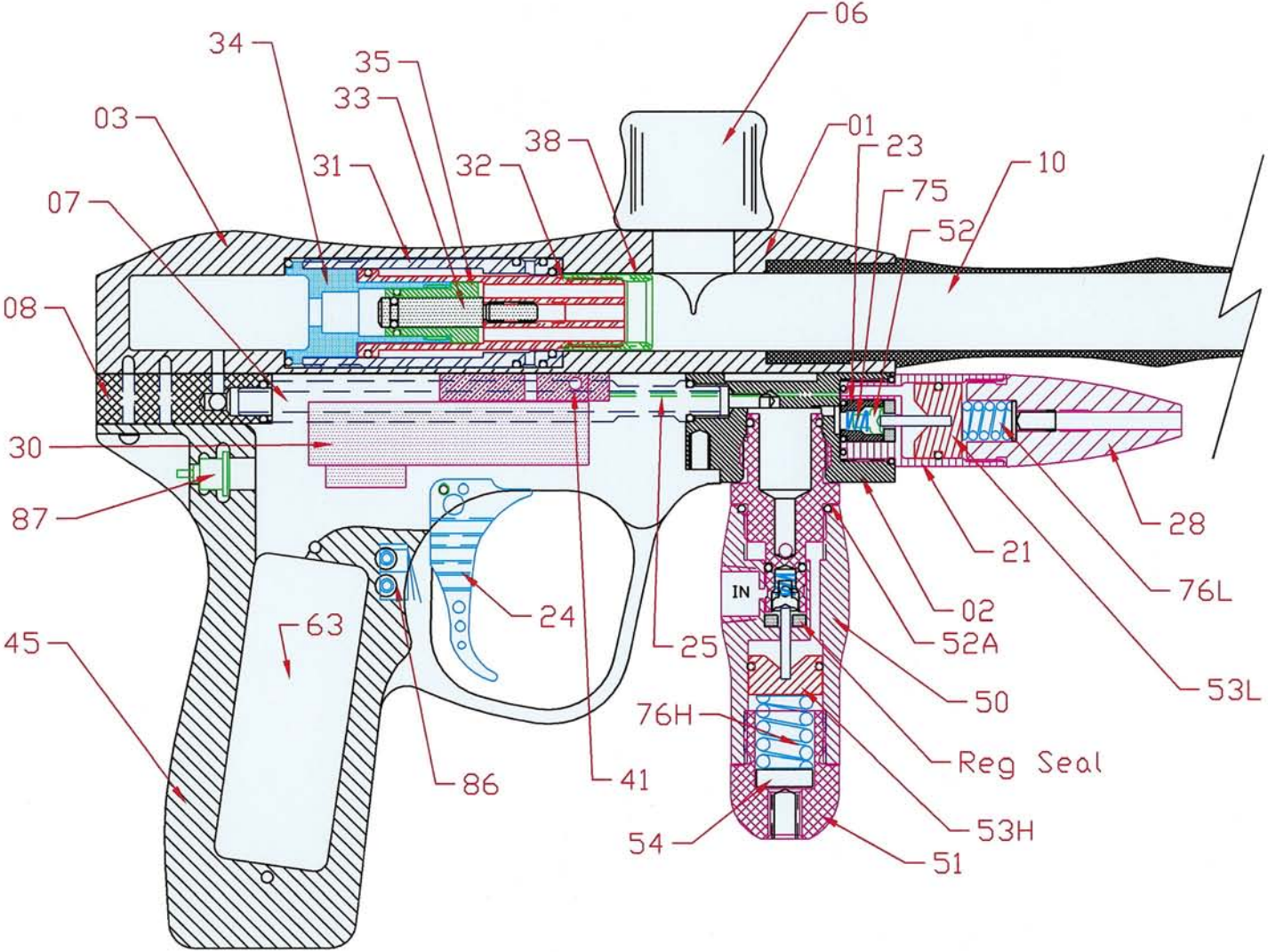

Drawing #	Part #	Description
1	303001	Front Main Body
2	303002	Regulator Mount
3	303003	Rear Main Body
6	303006	Clamping Feed Tube
7	303007	Air Tube
8	303008	Rear Body Manifold
10	303010	12 Inch Barrel
21	303021	LP Regulator Body
23	303023	LP Cup Housing
24	303024	Trigger Actuator
25	bluehose	LP Blue Hose for 10/32 barbs
28	303028	LP Adjustment Cap
30	303030H	Humphrey Solenoid Valve
31	303031	Cylinder Body
32	303032	Piston
33	303033	Valve Pin
34	303034	Valve Housing
35	303035	Valve Tip
38	303038	Bolt Tip
41	303041	Solenoid Manifold
45	303045	Clamshell Grip Frame
50	303050	HP Reg. Body
51	303051	HP Adjustment Cap
52	982052	Regulator Cup
54	303054	HP/LP Spring Spacer
63	PCB9300	Circuit Board
75	935075	Reg. Cup Spring
86	303086	Micro-Switch
87	303087	Toggle On/Off Switch
52A	303052	HP Reg. Adaptor
53H	982053H	HP Plunger
53L	982053L	LP Plunger
76H	992076	HP Reg. Main Spring
76L	982076	LP Reg. Main Spring
reg seal	D63389	Regulator Seal UR92

# 2004 FreeStyle™ Marker

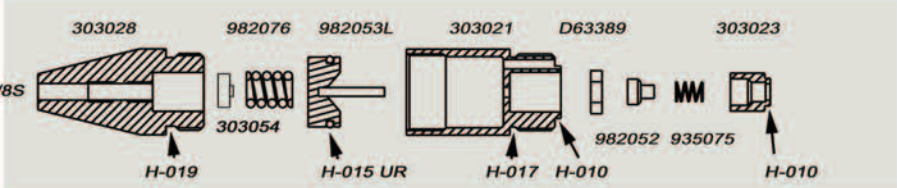
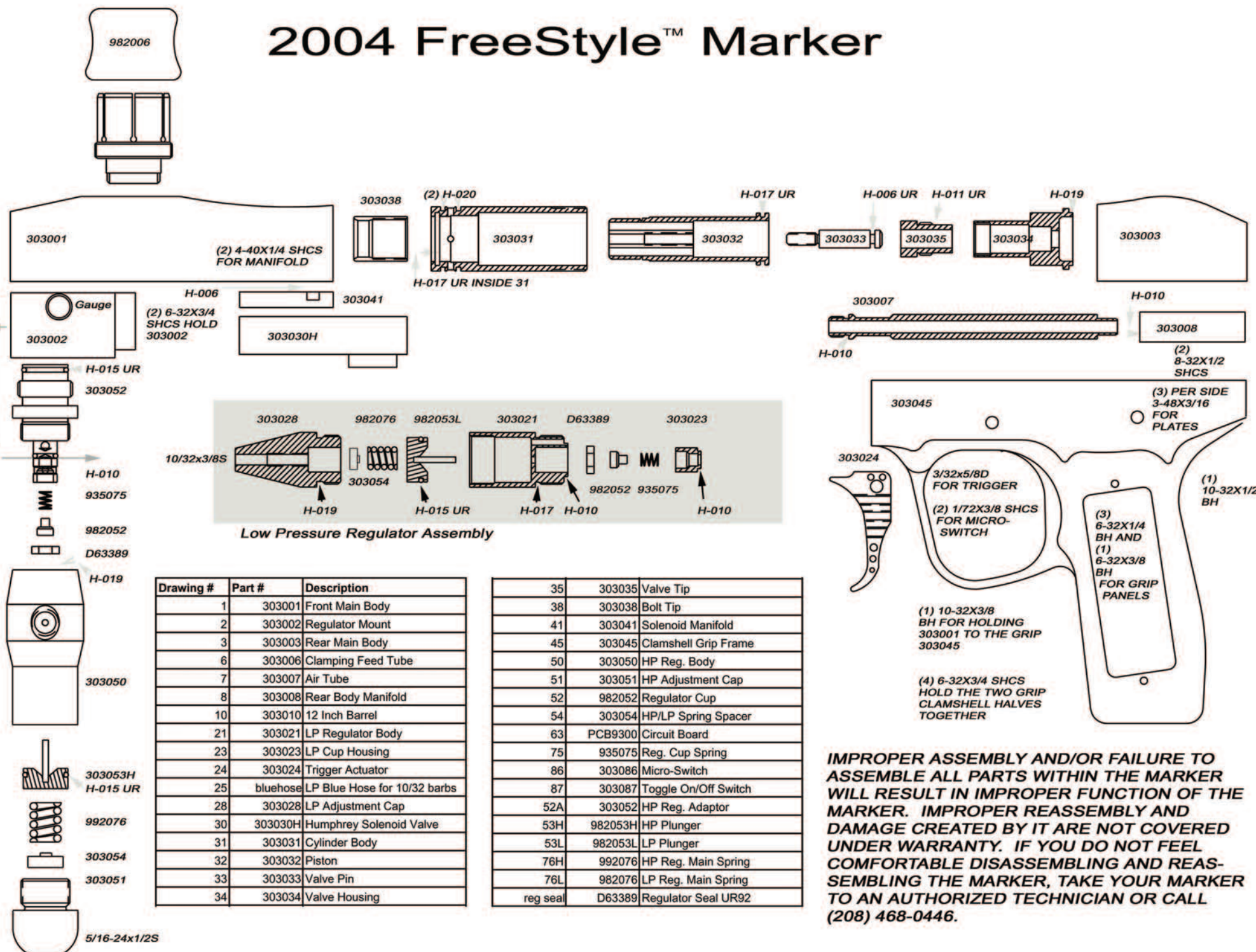

Low Pressure Regulator Assembly

Drawing #	Part #	Description
1	303001	Front Main Body
2	303002	Regulator Mount
3	303003	Rear Main Body
6	303006	Clamping Feed Tube
7	303007	Air Tube
8	303008	Rear Body Manifold
10	303010	12 Inch Barrel
21	303021	LP Regulator Body
23	303023	LP Cup Housing
24	303024	Trigger Actuator
25	bluehose	LP Blue Hose for 10/32 barbs
28	303028	LP Adjustment Cap
30	303030H	Humphrey Solenoid Valve
31	303031	Cylinder Body
32	303032	Piston
33	303033	Valve Pin
34	303034	Valve Housing

35	303035	Valve Tip
38	303038	Bolt Tip
41	303041	Solenoid Manifold
45	303045	Clamshell Grip Frame
50	303050	HP Reg. Body
51	303051	HP Adjustment Cap
52	982052	Regulator Cup
54	303054	HP/LP Spring Spacer
63	PCB9300	Circuit Board
75	935075	Reg. Cup Spring
86	303086	Micro-Switch
87	303087	Toggle On/Off Switch
52A	303052	HP Reg. Adaptor
53H	982053H	HP Plunger
53L	982053L	LP Plunger
76H	992076	HP Reg. Main Spring
76L	982076	LP Reg. Main Spring
reg seal	D63389	Regulator Seal UR92

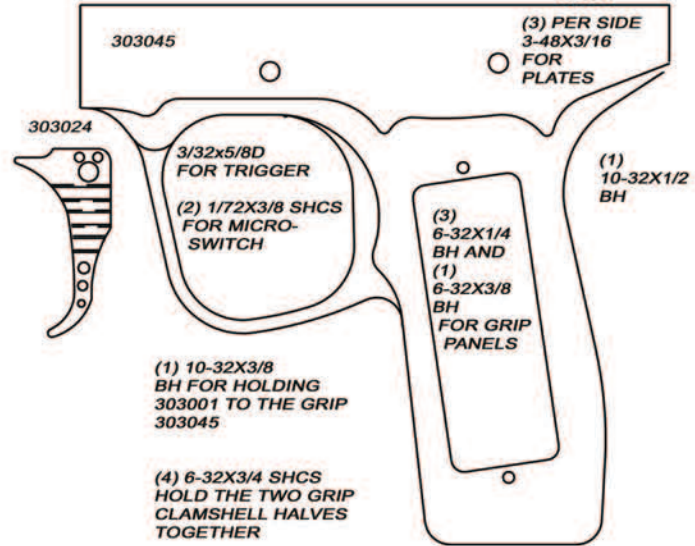

**IMPROPER ASSEMBLY AND/OR FAILURE TO ASSEMBLE ALL PARTS WITHIN THE MARKER WILL RESULT IN IMPROPER FUNCTION OF THE MARKER. IMPROPER REASSEMBLY AND DAMAGE CREATED BY IT ARE NOT COVERED UNDER WARRANTY. IF YOU DO NOT FEEL COMFORTABLE DISASSEMBLING AND REASSEMBLING THE MARKER, TAKE YOUR MARKER TO AN AUTHORIZED TECHNICIAN OR CALL (208) 468-0446.**

Indian Creek Design, Inc. Warranty Registration Card

PRODUCT MODEL \_\_\_\_\_

SERIAL # \_\_\_\_\_

NAME \_\_\_\_\_

ADDRESS \_\_\_\_\_

\_\_\_\_\_

CITY \_\_\_\_\_ STATE \_\_\_\_\_

ZIP \_\_\_\_\_ COUNTRY \_\_\_\_\_

PHONE \_\_\_\_\_

EMAIL \_\_\_\_\_

PURCHASED DATE \_\_\_\_\_

PURCHASED FROM \_\_\_\_\_

DEALER     INTERNET     DISTRIBUTOR     MAIL ORDER

*Please fill out this warranty registration page and mail to:*

**INDIAN CREEK DESIGN  
1019 FIRST STREET NORTH  
NAMPA, ID 83687**

*Or access our website, [www.ICDPaintball.com](http://www.ICDPaintball.com) for online registration.*