



Cal. .68



TRAINING FOR ENGAGEMENT



# TX 68

OPERATING  
INSTRUCTIONS

[WWW.UMAREX.COM](http://WWW.UMAREX.COM)

<b>EN</b>	01 Muzzle	<b>DE</b>	01 Mündung	<b>FR</b>	01 Bouche	<b>ES</b>	01 Boca del cañón
	02 Front sight		02 Korn		02 Guidon		02 Punto de mira
	03 Picatinny rail		03 Picatinny-Schiene		03 Rails picatinny		03 Riel Picatinny
	04 Rear sight		04 Kimme		04 Cran de mire		04 Alza
	05 Pressure indicator		05 Druckanzeiger		05 Indicateur de pression		05 Tornillo de Quick Piercing
	06 Stock		06 Schaft		06 Crosse		06 Culata
	07 Quick-Piercing Button		07 Quick-Piercing-Knopf		07 Bouton de perçage rapide		07 Botón de pinchado rápido
	08 Stock release		08 Schaftentriegelung		08 Verrou de la crosse		08 Desbloqueo de la culata
	09 Safety		09 Sicherung		09 Sécurité		09 Seguro
	10 Trigger		10 Abzug		10 Détente		10 Gatillo
	11 Loading port		11 Ladeöffnung		11 Ouverture de chargement		11 Orificio de carga
	12 Magazine		12 Magazin		12 Chargeur		12 Cargador
	13 Handguard		13 Vorderschaft		13 Fût		13 Guardamanos
	14 Picatinny rail		14 Picatinny-Schiene		14 Rails picatinny		14 Riel Picatinny
<b>IT</b>	01 Bocca	<b>RU</b>	01 Дуло	<b>PL</b>	01 Wylot lufy	<b>TR</b>	01 Namlu ağzı
	02 Mirino		02 Мушка		02 Muszka		02 Arpacık
	03 Slitta Picatinny		03 Направляющая типа Picatinny		03 Szyna Picatinny		03 Picatinny rayı
	04 Tacca di mira		04 Прицельная планка		04 Szczerbina		04 Gez
	05 Indicatore di pressione		05 Индикатор давления		05 Wskaźnik ciśnienia		05 Basınç göstergesi
	06 Calcio		06 Приклад		06 Kolba		06 Kundak
	07 Pulsante a tiro rapido		07 Кнопка для быстрого прокола		07 Przycisk szybkiego przekłuwania		07 Hızlı kapsül delme düğmesi
	08 Sbloccaggio del calcio		08 Фиксатор приклада		08 Odblokowanie rękojeści		08 Kundak kilidi açma
	09 Sicura		09 Предохранитель		09 Bezpiecznik		09 Emniyet
	10 Grilletto		10 Спусковой крючок		10 Spust		10 Tetik
	11 Apertura per il caricatore		11 магазинное оружие		11 Otwór do ładowania pocisku		11 şarj açılış
	12 Caricatore		12 Магазин		12 Magazynek		12 Şarjör
	13 Asta		13 Цевье		13 Wałek przedni		13 Kundak ön kısım
	14 Slitta Picatinny		14 Направляющая типа Picatinny		14 Szyna Picatinny		14 Picatinny rayı

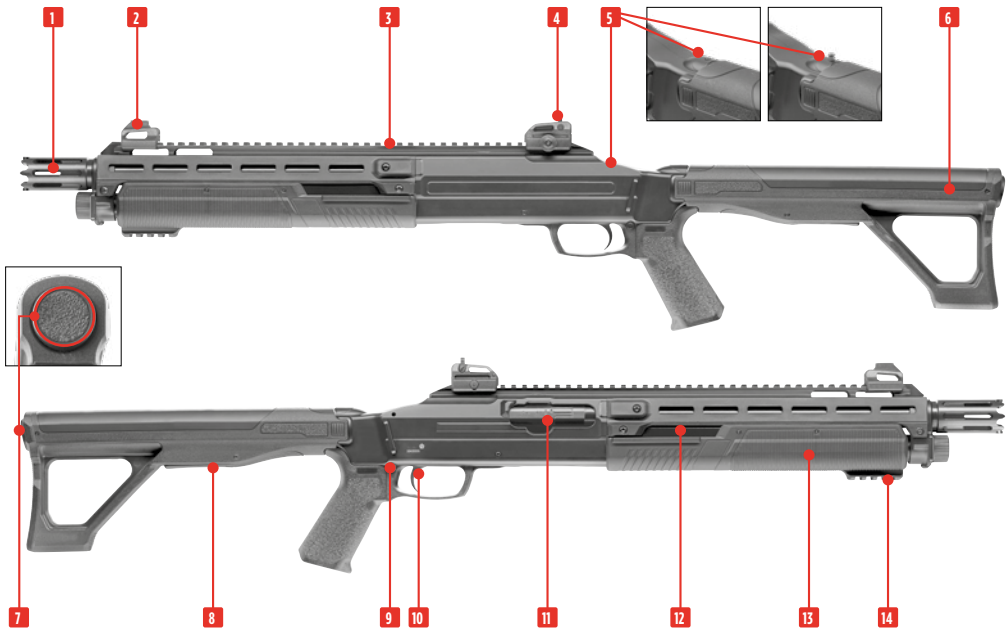

**CAUTION**

Only handle your gun in its safe condition.  
Always make sure that the muzzle points in a safe direction.

**ACHTUNG**

Hantieren Sie nur mit der Waffe, wenn diese gesichert ist.  
Achten Sie stets darauf, dass die Mündung in eine sichere Richtung zeigt.

**ATTENTION**

Ne manipulez l'arme que lorsque la sécurité est enclenchée.  
Assurez-vous que la bouche est orientée dans une direction non dangereuse.

**ATENCIÓN**

Manipule la pistola sólo cuando esté asegurada.  
Asegúrese de que la boca apunte siempre en una dirección segura.

**ATTENZIONE**

Accertarsi che la sicura sia inserita prima di iniziare a maneggiare l'arma.  
Indirizzate l'arma sempre in una direzione sicura.

**ВНИМАНИЕ**

Обращайтесь с оружием, только поставив его на предохранитель.  
Всегда следите за тем, чтобы ствол оружия был направлен в безопасную сторону.

**UWAGA**

Proszę posługiwać się wyłącznie zabezpieczoną bronią.  
Należy stale kontrolować czy lufa jest skierowana w bezpiecznym kierunku.

**DIKKAT**

Silahi sadece, emniyetli halde iken elinize alın.  
Namlunun her zaman güvenli bir yöne doğrultulmuş olmasına dikkat edin.

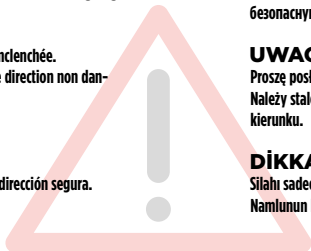



**Never use the following balls:** (1) with burr, (2) both halves not aligned, (3) used, soiled. Use of unsuitable projectiles will void the warranty.

**Verwenden Sie auf keinen Fall folgende Kugeln:** (1) mit Grat, (2) versetzte Hälften, (3) gebraucht, verschmutzt. Bei Gebrauch ungeeigneter Geschosse erlischt die Garantie.

**N'utilisez jamais des billes BB :** (1) avec angles (2) aux moitiés décalées (3) usagées ou sales. L'utilisation de projectiles inappropriés entraîne l'annulation de la garantie.

**No utilice en ningún caso bolas:** (1) con rebabas, (2) con mitades desplazadas, (3) usadas o sucias. Si se utilizan proyectiles distintos de los apropiados, quedará anulada la garantía.



**In ogni caso non usare i seguenti pallini:** (1) deformati, (2) con metà sfalsate, (3) usati, sporchi. La garanzia decade in caso di uso di proiettili non adatti.

**Ни в коем случае не используйте следующие пули:** (1) с зазубринами, (2) со смещенными половинками, (3) использованные или загрязненные пули. При использовании непредназначенных пули, для данного типа оружия зарядов гарантия теряет силу.

**Proszę w żadnym wypadku nie używać następujących kulek:** (1) z zadziornymi, (2) z przestawionymi połówkami, (3) używanych i zabrudzonych. W przypadku stosowania niewłaściwych pocisków gwarancja wygasa.

**Kesinlikle şu tür mermiler kullanmayın:** (1) çapaklı, (2) yarısı ofsetli, (3) kullanılmış, kirlî. Uygun olmayan mühimmat kullanılması halinde garanti geçersiz hale gelir.

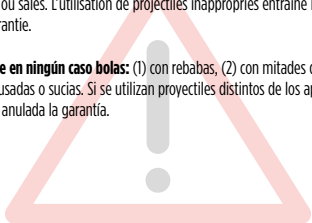

1



2



3



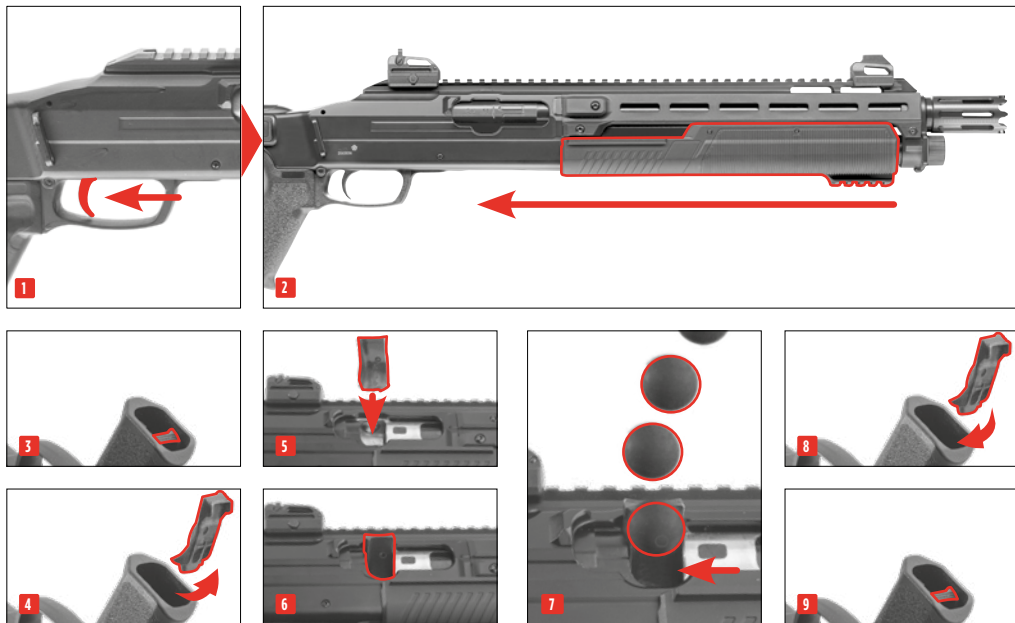

# 4

UNLOADING • ENTLADEN • DÉCHARGEMENT • DESCARGAR  
SCARICO • РАЗРЯЖЕНИЕ • WYŁADUNEK • BOŞALTMA

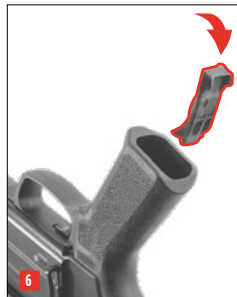
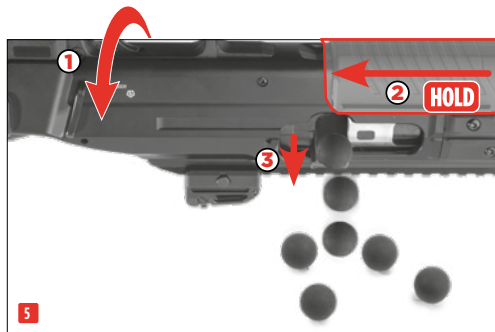
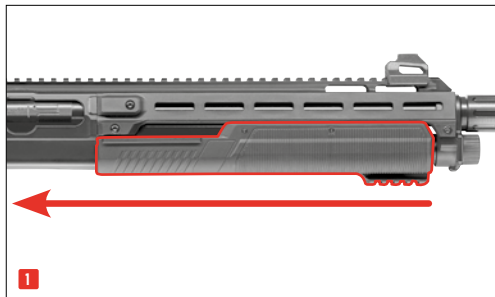

5

CHANGING THE CO<sub>2</sub> CAPSULE • AUSTAUSCHEN DER CO<sub>2</sub>-KAPSEL  
 REMPLACEMENT DE LA CAPSULE DE CO<sub>2</sub> • SUSTITUCIÓN DE LA CÁPSULA DE  
 CO<sub>2</sub> • SOSTITUZIONE DELLA CAPSULA DI CO<sub>2</sub> • ЗАМЕНА КАПСУЛЫ CO<sub>2</sub>  
 WYMIANA KAPSULEY CO<sub>2</sub> • CO<sub>2</sub> KAPSÜLÜNÜN DEĞİŞTİRİLMESİ

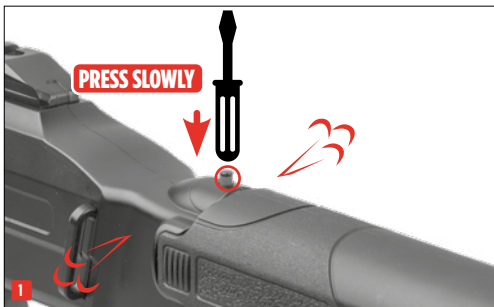

6

INSERT CO<sub>2</sub> CAPSULE • CO<sub>2</sub>-KAPSEL EINSETZEN • INSÉRER LA CAPSULE DE  
 CO<sub>2</sub> • INSERTAR LA CÁPSULA DE CO<sub>2</sub> • INSERIRE LA CAPSULA DI CO<sub>2</sub> • ВСТАВЬТЕ  
 КАПСУЛЫ С CO<sub>2</sub> • WŁOŻYĆ KAPSULĘ CO<sub>2</sub> • CO<sub>2</sub> KAPSÜLÜ YERLEŞTİRİN



- Only use 12 / 88 g CO<sub>2</sub> capsules.
- For storage remove gas capsules.
- There may be a minor discharge of gas when you remove the gas capsules.

Make sure that your hands do not come into contact with discharged CO<sub>2</sub> gas. This may cause freezing of the skin. Do not expose the CO<sub>2</sub> cartridge to excessive heat and do not store it at temperatures exceeding 54 °C. Always adhere to the warnings and safety instructions of the manufacturer on the gas cartridge in respect to handling and storage of a CO<sub>2</sub> gas container.

- Verwenden Sie nur 12 / 88 g CO<sub>2</sub>-Kapseln.
- Für die Lagerung der Waffe CO<sub>2</sub>-Kapseln entnehmen!
- Beim Herausnehmen der CO<sub>2</sub>-Kapsel kann es zu einem leichten Austritt von CO<sub>2</sub> kommen.

Achten Sie darauf, dass Ihre Hände nicht mit austretendem CO<sub>2</sub>-Gas in Berührung kommen. Bei Kontakt mit der Hand kann es zu Erfrierungen kommen. Setzen Sie die CO<sub>2</sub>-Kapsel keiner großen Hitze aus und lagern Sie diese Behälter nicht bei Temperaturen über 54 °C. Halten Sie sich immer an die auf der CO<sub>2</sub>-Kapsel aufgedruckten Warn- und Sicherheitshinweise des Herstellers bezüglich Umgang und Lagerung der CO<sub>2</sub>-Kapsel.

- Utilisez seulement des capsules de CO<sub>2</sub> de 12 / 88 g.
- Retirez la capsule de CO<sub>2</sub> avant de ranger l'arme.
- En retirant la capsule de CO<sub>2</sub>, il est possible qu'une petite quantité de gaz s'échappe. Veillez à ce que vos mains n'entrent pas en contact avec le gaz CO<sub>2</sub> qui s'échappe. Le contact avec la peau peut entraîner des gelures. Ne soumettez pas les capsules de CO<sub>2</sub> à une chaleur trop importante et ne les stockez pas à des températures supérieures à 54 °C. Respectez toujours les consignes de sécurité et avertissements figurant sur la capsule de CO<sub>2</sub> relatifs à l'utilisation et au stockage de capsules de CO<sub>2</sub>.

- Utilice únicamente cápsulas CO<sub>2</sub> de 12 g / 88 g.
- Para guardar el arma extraiga los cápsulas de CO<sub>2</sub>.
- Al extraer el cápsula de CO<sub>2</sub>, es posible que se escape una pequeña cantidad de gas. Procure que sus manos no entren en contacto con el CO<sub>2</sub> en caso de fuga, ya que un eventual contacto con la piel puede causar congelación. No exponga el cápsula de CO<sub>2</sub> a un calor excesivo ni lo guarde a temperaturas superiores a los 54 °C. Observe siempre las advertencias e instrucciones de seguridad del fabricante sobre la manipulación y el almacenamiento del cápsula de aire comprimido.





- Usare solo le capsula CO<sub>2</sub> 12/88 g.
- Prima di riporre l'arma, togliere la capsula CO<sub>2</sub>!
- Durante l'estrazione della capsula CO<sub>2</sub> può verificarsi una leggera fuoriuscita di gas CO<sub>2</sub>.

Raccomandiamo di prestare attenzione affinché le mani non vengano a contatto con il gas CO<sub>2</sub> che fuoriesce dall'arma. L'eventuale contatto con la pelle potrebbe provocare congelamenti. Non esporre le capsula CO<sub>2</sub> a fonti di calore eccessivo e conservarle in contenitori a temperature non superiori a 54 °C. Osservare sempre le avvertenze e le norme di sicurezza del produttore stampate sulla capsula relative all'utilizzo e alla conservazione delle capsula CO<sub>2</sub>.

- Применять только баллончики с 12 / 88 г CO<sub>2</sub>.
  - При постановке оружия на хранение вынимать баллончик CO<sub>2</sub>!
  - При извлечении баллончика CO<sub>2</sub> может произойти незначительная утечка CO<sub>2</sub>.
- Обратите внимание на то, чтобы Ваши руки не соприкасались с выходящим газом CO<sub>2</sub>. При контакте с кожей может наступить обморожение. Берегите баллончик с газом CO<sub>2</sub> от перегрева и не храните его при температуре выше 54 °C. Всегда соблюдайте напечатанные производителем на баллончике CO<sub>2</sub> указания по мерам безопасности в отношении обращения и хранения баллончика CO<sub>2</sub>.

- Proszę używać tylko naboju 12 / 88 g CO<sub>2</sub>.
  - Broń należy przechowywać bez naboju CO<sub>2</sub>!
  - Przy wyciąganiu naboju CO<sub>2</sub> może dojść do małego wycieku dwutlenku węgla.
- Proszę chronić ręce przed zetknięciem z wyciekami dwutlenku węgla. W kontakcie CO<sub>2</sub> ze skórą może dojść do odmrożeń. Naboju CO<sub>2</sub> nie należy wystawiać go na działanie wysokiej temperatury, proszę przechowywać go poniżej w temp 54°C. Proszę przestrzegać wskazówek producenta dot. zasad bezpieczeństwa przy obsłudze i przechowywaniu naboju CO<sub>2</sub>. Informacje te znajdują Państwo na naboju.

- Sadece 12 / 88 g\*lık CO<sub>2</sub> kapsülleri kullanın.
- Silahı saklamadan önce CO<sub>2</sub> kapsülünü çıkarın!
- CO<sub>2</sub> kapsülünü çıkarırken biraz CO<sub>2</sub> sızabilir.

Ellerinizi silahtan çıkan CO<sub>2</sub> gazıyla temas etmemesine dikkat edin. Elinizle temas halinde deride donmalar oluşabilir. CO<sub>2</sub> kapsülünü aşırı sıcak koşullara maruz bırakmayın ve bu kapları 54 °C'den daha sıcak ortamlarda saklamayın. CO<sub>2</sub> kapsülü üzerinde yer alan, CO<sub>2</sub> kapsülünün kullanımı ve saklanmasıyla ilgili basılı üretici uyarı ve güvenlik bilgilerine daima uyun.

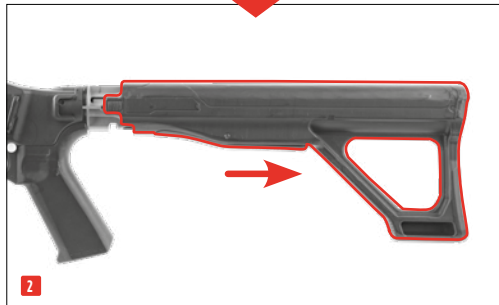

**6**

INSERT CO<sub>2</sub> CAPSULE • CO<sub>2</sub>-KAPSEL EINSETZEN • INSÉRER LA CAPSULE DE CO<sub>2</sub> • INSERTAR LA CÁPSULA DE CO<sub>2</sub>  
INSERIRE LA CAPSULA DI CO<sub>2</sub> • ВСТАВЬТЕ КАПСУЛУ С CO<sub>2</sub> • WŁOŻYĆ KAPSUŁĘ CO<sub>2</sub> • CO<sub>2</sub> KAPSÜLÜ YERLEŞTİRİN

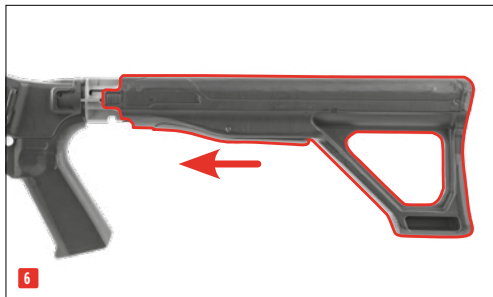
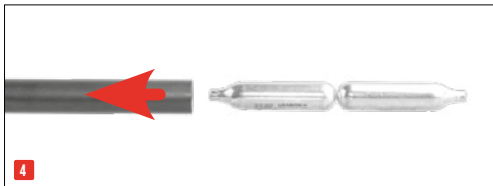
**2.4745 / 2.4746**

2.4747 + Adapter 2.4747.4 (2x 12g)



3



4



5

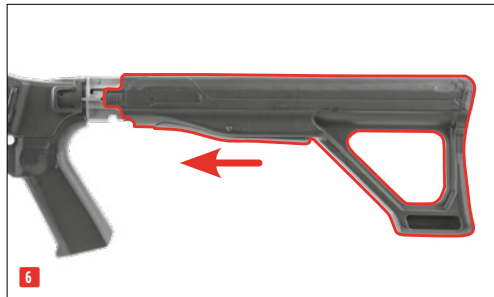

6



7

**6**

INSERT CO<sub>2</sub> CAPSULE • CO<sub>2</sub>-KAPSEL EINSETZEN • INSÉRER LA CAPSULE DE CO<sub>2</sub> • INSERTAR LA CÁPSULA DE CO<sub>2</sub>  
INSERIRE LA CAPSULA DI CO<sub>2</sub> • ВСТАВЬТЕ КАПСУЛУ С CO<sub>2</sub> • WŁOŻYĆ KAPSUŁĘ CO<sub>2</sub> • CO<sub>2</sub> KAPSÜLÜ YERLEŞTİRİN

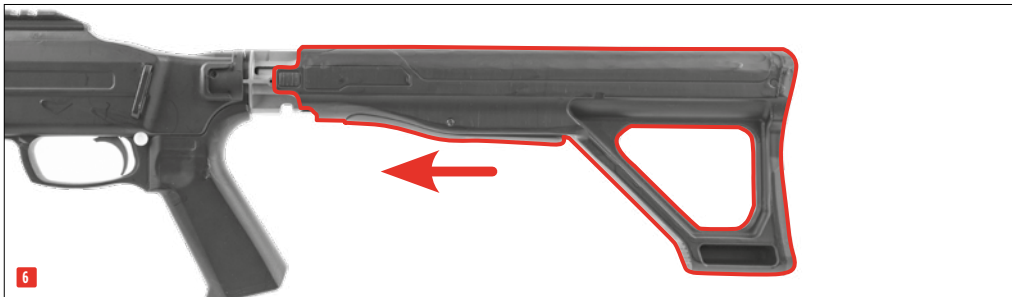
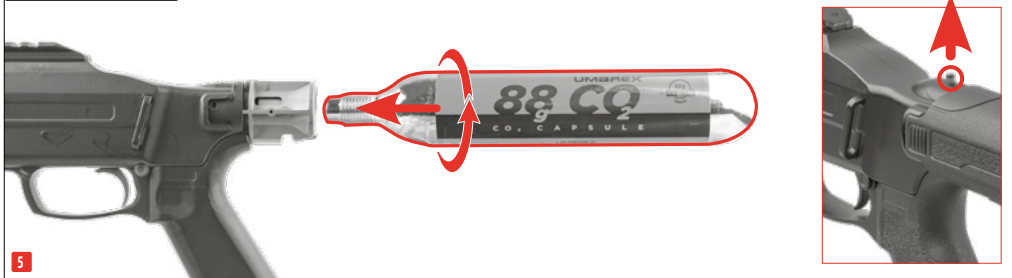
**2.4747 · 1 x 88g Capsules**

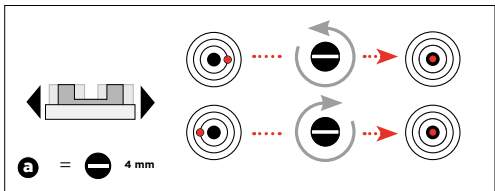
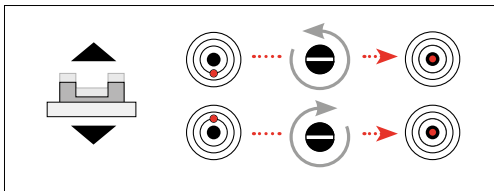
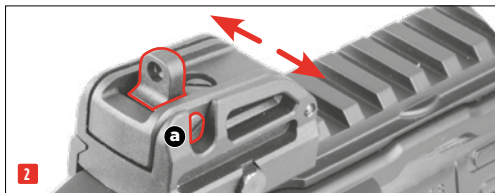
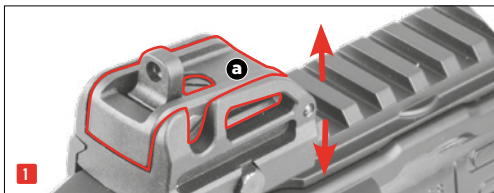

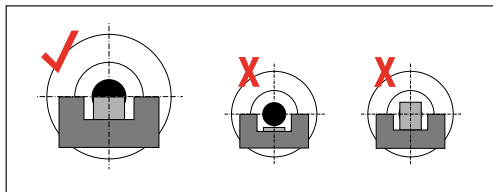
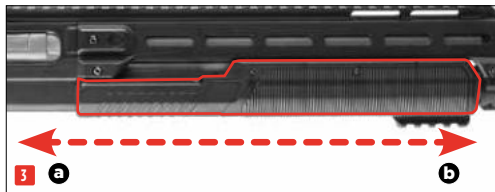
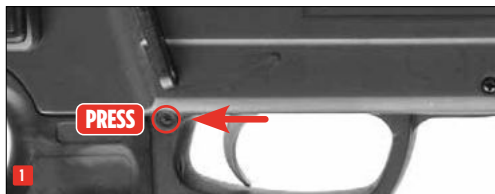

System / Power Source • System / Antrieb • Système / Source de Propulsion  
 Sistema / Propulsión • Sistema / Alimentazione • Система / Источник энергии  
 System / Zródło • Sistem / Enerji kaynağı

CO<sub>2</sub> Rifle • CO<sub>2</sub>-Gewehr • Fusil CO<sub>2</sub> • Riffle de CO<sub>2</sub>  
 Fucile a CO<sub>2</sub> • винтовка CO<sub>2</sub> • Karabin CO<sub>2</sub> • CO<sub>2</sub> tüfeği

Caliber / Ammo • Kaliber / Munition • Calibre / Munitions • Kaliber / Munición  
 Calibro / Munizioni • Калибр • Kaliber / Amunición • Kalibre / Mühimmat

.68

Capacity • Kapazität • Capacité • Capacidad  
 Capacità • Емкость магазина • Pojemność magazynka • Şarjör kapasitesi

16

Energy / Velocity • Energie / Geschwindigkeit • Énergie / Vitesse  
 Energia / Velocidad • Energia / Velocità • Энергия / Скорость полета пули  
 Energia / Prędkość • Enerji / Mermi hızı

**2.4745:**

**< 7,5 J:** 70 m/s



**2.4746:**

**16 J:** 105 m/s

**2.4747:**

**40 J:** 165 m/s

Stock • Schaft • Crosse • Culata • Calcio • Приклад • Kolba • Renk

polymer • Polymer • synthétique • sintético • sintetico • Пластик • tworzywo sztuczne • plastik

Safety • Sicherung • Sécurité • Seguro  
 Sikura • предохранитель • Bezpiecznik • Emniyet

manual • manuell • manuel • manual • manuale • ручной • manualny • manuel

Barrel length • Lauflänge • Logueur canon • Longitud del cañón  
 Lunghezza canna • Длина ствола • Długość lufy • Namlu uzunluğ

366 mm

366 mm

366 mm

Dangerous area up to • Max. Gefahrenbereich bis zu • Zone de danger  
 s'étendant • Distancia máxima de peligro • Distanza massima di pericolo • Макс.  
 протяженность опасной зоны • Maks. obszar zagrożenia do • Maksimum  
 tehlike alanı

250 m

350 m

450 m

Weight • Gewicht • Poids • Peso • Peso • Вес • Waga • Ağırlık

3055 g

3055 g

2850 g

Overall length • Gesamtlänge • Longueur • Longitud  
 Lunghezza • Длина • Długość całkowita • Toplam uzunluk

896 mm

**PROBLEMS • PROBLEME  
 DYSFONCTIONNEMENTS • PROBLEMAS  
 PROBLEMI • ПРОБЛЕМЫ  
 PROBLEMY • PROBLEMLER**
**POSSIBLE CAUSES • MÖGLICHE GRÜNDE  
 CAUSES POSSIBLES • POSIBLES CAUSAS  
 POSSIBILI CAUSE • ВОЗМОЖНЫЕ ПРИЧИНЫ  
 MOŻLIWE PRZYCZYNY • OLASI NEDENLER**

Safety activated  
 Waffe gesichert  
 Sécurité de l'arme enclenchée  
 Seguro activado  
 Sicura attivata  
 Оружие стоит на предохранителе  
 Broń zabezpieczona  
 Silah emniyette

CO<sub>2</sub> capsule not pierced  
 CO<sub>2</sub>-Kapsel nicht angestochen  
 Capsule de CO<sub>2</sub> non percée rcée  
 Cápsula de CO<sub>2</sub> sin perforar  
 Capsula a CO<sub>2</sub> non bucata  
 Отсутствие накола баллончика с CO<sub>2</sub>  
 Nabój CO<sub>2</sub> nie przekłuty  
 CO<sub>2</sub> kapsülü delinmemiş

Dirty barrel  
 Lauf verschmutzt  
 Canon encrassé  
 Cañón sucio  
 Cannu sporca internamente  
 Ствол загрязнен  
 Zanieczyszczona lufa  
 Namlu kirlı

Gun does not shoot • Waffe schießt nicht  
 l'arme ne tire pas • El arma no dispara  
 L'arma non spara • Плохие показатели стрельбы  
 złe efekty strzelania • Kötü atış performansı



Faulty shooting direction • Schlechte Schussleistung  
 Mauvaise performance de tir • Potencia de disparo deficiente  
 Scarsa precisione • Оружие не стреляет  
 broń nie strzela • Silah atış almıyor



Low shooting speed • Geringe Schussgeschwindigkeit  
 Faible vitesse du projectile • Escasa velocidad de disparo  
 Velocità ridotta del proiettile • Слабая скорость полета пули  
 niska prędkość śrutu • Merminin hızı düşük





---

CO<sub>2</sub> capsule / Magazine empty  
CO<sub>2</sub> -Kapsel / Magazin leer  
Capsule de CO<sub>2</sub> / Chargeur vide  
Capsula a CO<sub>2</sub> / Caricatore vuoto  
Cápsula de CO<sub>2</sub> / Cargador vacío  
Балончик с CO<sub>2</sub> / Магазин пустой  
Nabój CO<sub>2</sub> / Magazynek pusty  
CO<sub>2</sub> kapsülü / şarjör boş

Extreme temperatures  
Extreme Temperaturen  
Températures extrêmes  
Temperaturas extremas  
Temperature estreme  
Экстремальные температуры  
Ekstremalne temperatur  
Aşırı sıcak/soğuk

Wrong ammunition  
Falsche Munition  
Mauvaises munitions  
Munición errónea  
Munición mal cargada  
Munizione sbagliata  
Боеприпасы не подходят  
Zła amunicja  
Yanlış mühimmat

Ammunition badly loaded  
Munition falsch geladen  
Munitions mal chargées  
Munición mal cargada  
Munizione caricata in maniera errata  
Боеприпасы неправильно снаряжены  
Niepoprawnie załadowana amunicja  
Mühimmat yanlış doldurulmuş

Sight not properly adjusted  
Visierung nicht richtig eingestellt  
Dispositif de visée mal réglé  
La mira no está bien ajustada  
Dispositivo di mira non regolato  
correttamente  
Неправильно установлен прицел  
Błędnie ustawiony celownik  
Nişangâh doğru ayarlanmamış





## 2.4745

UMAREX REF. NO.:	PARTNUMBER:	ITEM:	UMAREX REF. NO.:	PARTNUMBER:	ITEM:
81.10.0001	1E	BACK STOCK COMBINATION	81.60.0004	1B	BB FOLLOWER COMBINATION
81.10.0002	E-03	IMPACT SEAT	81.60.0005	1D	VALVE CASING COMBINATION
81.10.0003	E-04	STOCK COVER	81.60.0006	7	VALVE CHAMBER COMBINATION
81.10.0004	E-08	IMPACT SEAT SPRING	81.60.0007	8B	CHAMBER COMBINATION
81.20.0001	1-18	SCREW 5X16	81.60.0079	A-25	O-RING 2.5X1.5
81.20.0002	1-25	SPEED LOADER SEAT	81.60.0224	8F	PIERCER SCREW ASSY
81.20.0003	1-26	SPEED LOADER	81.60.0225	A-18	WASHER 3.2X6X0.5
81.20.0004	A-03	TRIGGER	81.60.0226	A-22	CO <sub>2</sub> TUBE CONNECTOR
81.20.0005	A-04	TRIGGER CONNECTOR	81.60.0227	A-23	COPPER RING
81.20.0006	A-08	POINT	81.70.0001	1CM	FRONT SIGHT COMBINATION
81.20.0007	A-12	TRIGGER CONNECTOR SPRING	81.70.0002	1DDM	SIGHT SEAT COMBINATION
81.20.0009	A-17	TRIGGER RELEASE SPRING			
81.20.0010	A-24	TRIGGER RELEASE PARTS			
81.20.0011	1F	TRIGGER CONNECTOR COMBINATION			
81.20.0265	A-14	POINT SPRING			
81.30.0001	1-13	SCREW 2X6			
81.30.0002	1-14	SCREW 3X10			
81.30.0003	1-15	SCREW 4X6.5			
81.30.0004	1-16	SCREW 4X42			
81.30.0005	1-17	SCREW 3X10			
81.40.0001	1-24	RECOIL SPRING			
81.50.0001	A-06	BB STOPPER CATCH			
81.50.0002	A-07	BB STOPPER			
81.50.0003	A-13	BB STOPPER CATCH SPRING			
81.50.0004	A-16	BB STOPPER SPRING			
81.50.0005	A-21	BB STOPPER			
81.60.0001	1-22	MAGAZINE SPRING			
81.60.0002	1-23	O-RING 20.5X1.5			
81.60.0003	A-15	VALVE CASING SPRING			



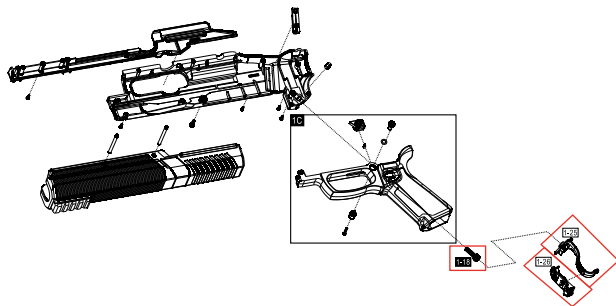
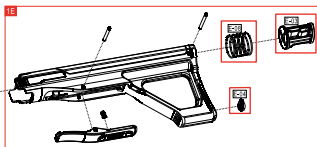
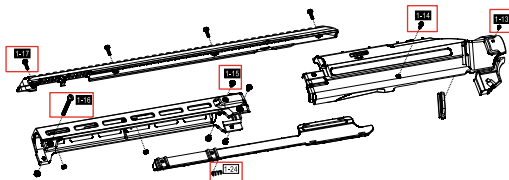
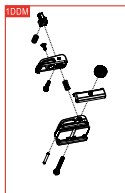
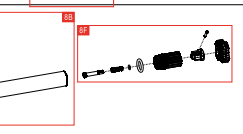



## 2.4746

UMAREX REF. NO.:	PARTNUMBER:	ITEM:	UMAREX REF. NO.:	PARTNUMBER:	ITEM:
81.10.0001	1E	BACK STOCK COMBINATION	81.60.0004	1B	BB FOLLOWER COMBINATION
81.10.0002	E-03	IMPACT SEAT	81.60.0005	1D	VALVE CASING COMBINATION
81.10.0003	E-04	STOCK COVER	81.60.0079	A-25	O-RING 2.5X1.5
81.10.0004	E-08	IMPACT SEAT SPRING	81.60.0224	8F	PIERCER SCREW ASSY
81.20.0001	1-18	SCREW 5X16	81.60.0225	A-18	WASHER 3.2X6X0.5
81.20.0002	1-25	SPEED LOADER SEAT	81.60.0226	A-22	CO <sub>2</sub> TUBE CONNECTOR
81.20.0003	1-26	SPEED LOADER	81.60.0227	A-23	COPPER RING
81.20.0004	A-03	TRIGGER	81.60.0228	7	VALVE CHAMBER COMBINATION
81.20.0005	A-04	TRIGGER CONNECTOR	81.60.0229	8B	CHAMBER COMBINATION
81.20.0006	A-08	POINT	81.70.0001	1CM	FRONT SIGHT COMBINATION
81.20.0007	A-12	TRIGGER CONNECTOR SPRING	81.70.0002	1DDM	SIGHT SEAT COMBINATION
81.20.0265	A-14	POINT SPRING			
81.20.0009	A-17	TRIGGER RELEASE SPRING			
81.20.0010	A-24	TRIGGER RELEASE PARTS			
81.20.0011	1F	TRIGGER CONNECTOR COMBINATION			
81.30.0001	1-13	SCREW 2X6			
81.30.0002	1-14	SCREW 3X10			
81.30.0003	1-15	SCREW 4X6.5			
81.30.0004	1-16	SCREW 4X42			
81.30.0005	1-17	SCREW 3X10			
81.40.0001	1-24	RECOIL SPRING			
81.50.0001	A-06	BB STOPPER CATCH			
81.50.0002	A-07	BB STOPPER			
81.50.0003	A-13	BB STOPPER CATCH SPRING			
81.50.0004	A-16	BB STOPPER SPRING			
81.50.0005	A-21	BB STOPPER			
81.60.0001	1-22	MAGAZINE SPRING			
81.60.0002	1-23	O-RING 20.5X1.5			
81.60.0003	A-15	VALVE CASING SPRING			

2.4746

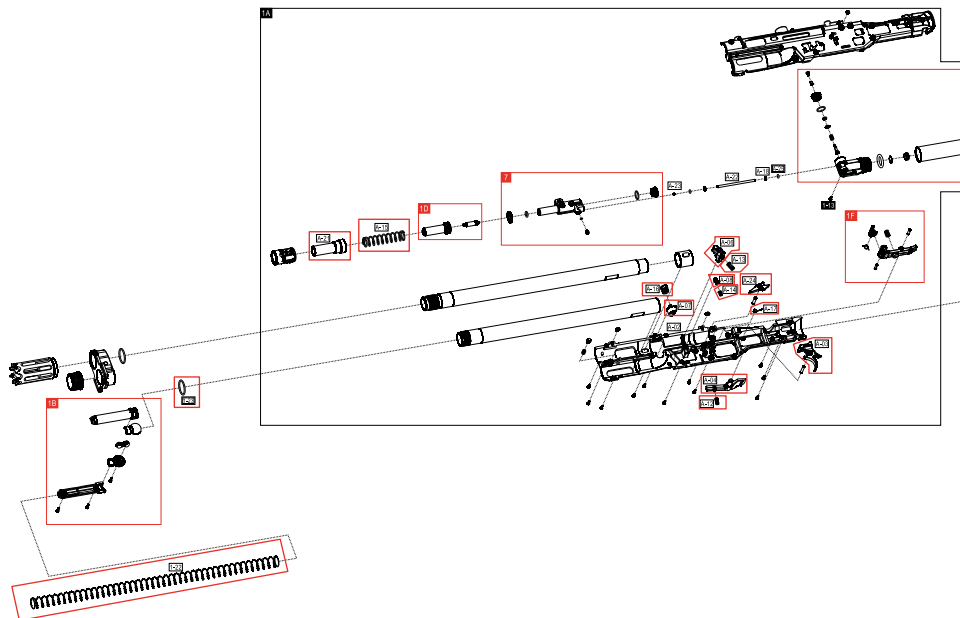



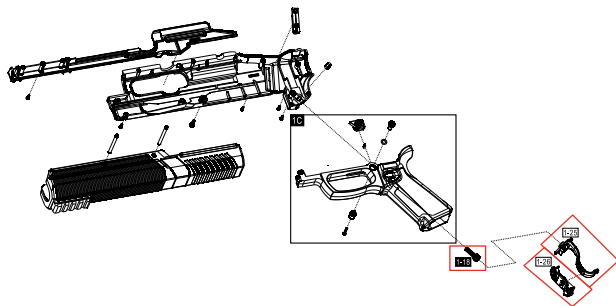
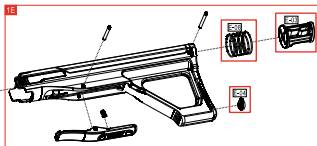
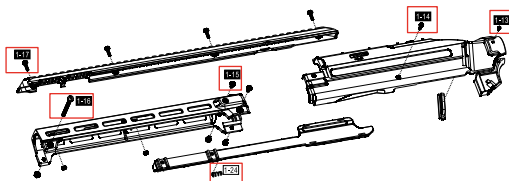
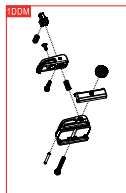
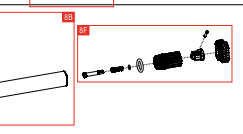

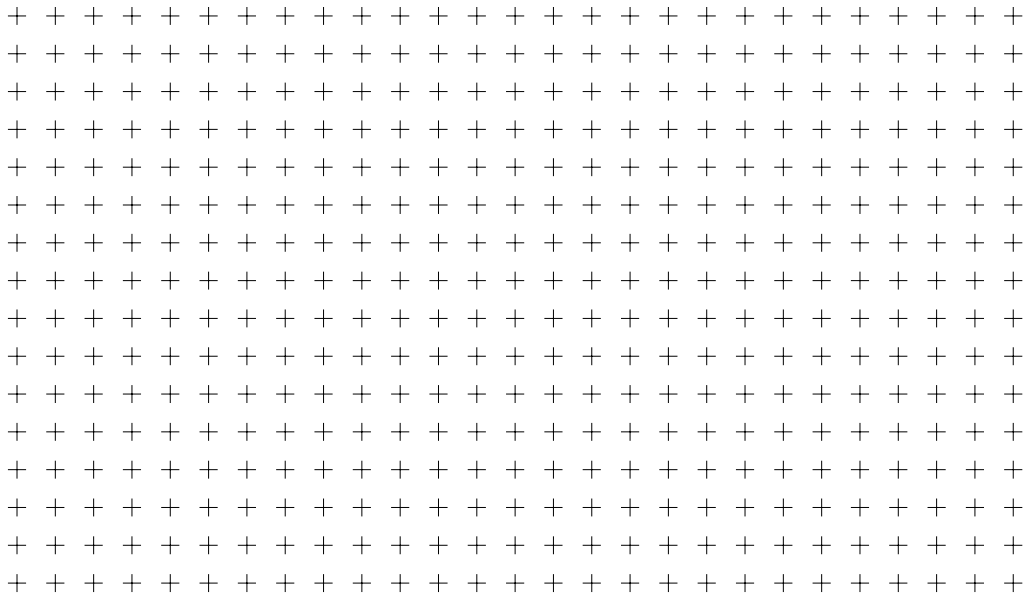

## 2.4747

UMAREX REF. NO.:	PARTNUMBER:	ITEM:	UMAREX REF. NO.:	PARTNUMBER:	ITEM:
81.10.0001	1E	BACK STOCK COMBINATION	81.60.0004	1B	BB FOLLOWER COMBINATION
81.10.0002	E-03	IMPACT SEAT	81.60.0005	1D	VALVE CASING COMBINATION
81.10.0003	E-04	STOCK COVER	81.60.0078	A-18	WASHER 3.0X6X0.5
81.10.0004	E-08	IMPACT SEAT SPRING	81.60.0079	A-25	O-RING 2.5X1.5
81.10.0134	1-17	SCREW 3X10	81.60.0226	A-22	CO <sub>2</sub> TUBE CONNECTOR
81.20.0001	1-18	SCREW 5X16	81.60.0227	A-23	COPPER RING
81.20.0002	1-25	SPEED LOADER SEAT	81.60.0230	7	VALVE CHAMBER COMBINATION
81.20.0003	1-26	SPEED LOADER	81.60.0231	8B	CHAMBER COMBINATION
81.20.0005	A-04	TRIGGER CONNECTOR	81.70.0001	1CM	FRONT SIGHT COMBINATION
81.20.0006	A-08	POINT	81.70.0002	1DDM	SIGHT SEAT COMBINATION
81.20.0007	A-12	TRIGGER CONNECTOR SPRING	81.70.0002	70	SIGHT SEAT COMBINATION
81.20.0009	A-17	TRIGGER RELEASE SPRING			
81.20.0010	A-24	TRIGGER RELEASE PARTS			
81.20.0011	1F	TRIGGER CONNECTOR COMBINATION			
81.20.0264	A-03	TRIGGER			
81.20.0265	A-14	POINT SPRING			
81.30.0001	1-13	SCREW 2X6			
81.30.0002	1-14	SCREW 3X10			
81.30.0003	1-15	SCREW 4X6.5			
81.30.0004	1-16	SCREW 4X42			
81.40.0001	1-24	RECOIL SPRING			
81.50.0001	A-06	BB STOPPER CATCH			
81.50.0002	A-07	BB STOPPER			
81.50.0003	A-13	BB STOPPER CATCH SPRING			
81.50.0004	A-16	BB STOPPER SPRING			
81.50.0005	A-21	BB STOPPER			
81.60.0001	1-22	MAGAZINE SPRING			
81.60.0002	1-23	O-RING 20.5X1.5			
81.60.0003	A-15	VALVE CASING SPRING			



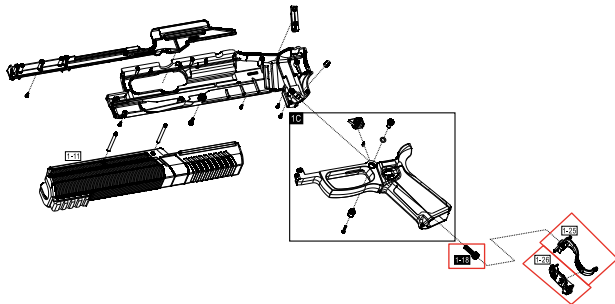
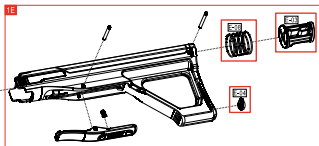
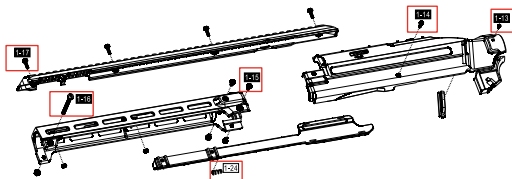
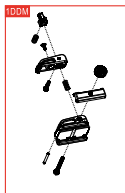







**EN** We reserve the right to make color and design changes and technical improvements. No responsibility is accepted for printing errors or incorrect information. **DE** Änderungen in Farbe und Design sowie technische Verbesserungen, Druckfehler und Irrtum vorbehalten. Alle Angaben ohne Gewähr. **FR** Sauf modifications de la couleur et du design ainsi que des améliorations techniques, erreurs d'impression et erreur. Toutes les données sont fournies sans garantie. **ES** Salvo modificaciones de color y de diseño así como mejoramientos técnicos, erratas y error. Todos los datos sin garantía. **IT** Con riserva di modifiché di colore e di design, di miglioramenti tecnici, di errori di stampa e di sbagli. Tutte le informazioni senza garanzia. **RU** Изменения цвета и дизайна, а также технические улучшения, опечатки и ошибки не исключены. Мы не гарантируем точность сведений. **PL** Zastrzegamy sobie prawo do pomyłek, błędów w druku, zmian koloru i designu, jak również do wprowadzania technicznych ulepszeń. Wszystkie informacje bez gwarancji. **TR** Renk, tasarım ve teknik değişiklikler yapma hakkı saklıdır. Baskı hatalarından ya da hatalı bilgilerden dolayı yasal sorumluluk kabul edilmez. Bilgiler için garanti verilmez.

**UMAREX GmbH & Co. KG • Donnerfeld 2 • 59757 Arnsberg • Germany • [service@umarex.de](mailto:service@umarex.de)**

**WWW.UMAREX.COM**

Covers models:

2.4745

2.4746

2.4747