

→ THE COMPLETE GUIDE TO LUXE® OWNERSHIP & MAINTENANCE ←

# OWNER'S MANUAL



 LUXE<sup>®</sup> 2.0



FUNDAR

DLX

MMVIII

LUXEPAINTBALL.COM ✦ 866.573.LUXE

LUXE® MARKER IS COVERED BY ONE OR MORE OF THE FOLLOWING U.S. PATENTS: 5,881,707; 5,967,133; 6,035,843; 6,474,326; 6,637,421; 7,100,593.  
OTHER PATENTS PENDING. FOREIGN PATENTS GRANTED AND PENDING. ©2011 DLX TECHNOLOGY GROUP. ALL RIGHTS RESERVED.



\* TREAT EVERY PAINTBALL MARKER AS IF IT WERE LOADED. \*

\* NEVER LOOK DOWN THE BARREL OF A PAINTBALL MARKER. \*

\* KEEP THE LUXE® MARKER ON SAFE (POWER OFF) UNTIL READY TO SHOOT. \*

\* KEEP YOUR FINGER OFF THE TRIGGER UNTIL READY TO SHOOT. \*

\* NEVER POINT THE LUXE® MARKER AT ANYTHING YOU DON'T WISH TO SHOOT. \*

\* DO NOT SHOOT FRAGILE OBJECTS SUCH AS WINDOWS. \*

\* KEEP THE BARREL BLOCKING DEVICE ON THE LUXE® MARKER'S MUZZLE WHEN NOT SHOOTING. \*

\* ALWAYS REMOVE PAINTBALLS AND DEGAS THE LUXE® MARKER BEFORE DISASSEMBLY. \*

\* STORE AND TRANSPORT THE LUXE® MARKER UNLOADED AND DEGASSED IN A SECURE PLACE. \*

\* FOLLOW ALL MANUFACTURER'S WARNINGS AND INSTRUCTIONS FOR PROPELLANT \*  
SOURCE HANDLING, STORAGE, AND FILLING.





**LUXE**

**PREMIUM ELECTROPNEUMATIC MARKER**

LUXE® MARKER IS COVERED BY ONE OR MORE OF THE FOLLOWING U.S. PATENTS:  
5,881,707; 5,967,133; 6,035,843; 6,474,326; 6,637,421; 7,100,593.  
OTHER PATENTS PENDING. FOREIGN PATENTS GRANTED AND PENDING.  
©2008 DLX TECHNOLOGY GROUP. ALL RIGHTS RESERVED.

**THE PRECAUTION LIST AND OPERATOR'S MANUAL  
MUST ALWAYS ACCOMPANY THE PRODUCT IN THE EVENT  
OF RESALE OR NEW OWNERSHIP.**

※ LUXE 2.0 EDITION ※ REV 2.00

WHILE EVERY EFFORT HAS BEEN MADE TO ENSURE THAT THE INFORMATION  
CONTAINED IN THIS GUIDE IS ACCURATE AND COMPLETE, NO  
LIABILITY CAN BE ACCEPTED FOR ERRORS OR OMISSIONS.  
DLX TECHNOLOGY GROUP RESERVES THE RIGHT TO  
CHANGE THE SPECIFICATIONS OF THE LUXE® MARKER  
AT ANY TIME WITHOUT PRIOR NOTICE. THE LATEST  
VERSION OF THIS MANUAL MAY BE DOWNLOADED  
FREE OF CHARGE AT [LUXEPAINTBALL.COM](http://LUXEPAINTBALL.COM).



# CONTENTS

- 1.1 QUICK START ✖ ✖ ✖ 6 ✖
- 1.2 INSTALLING THE BARREL BLOCKER ✖ ✖ ✖ 9 ✖
- 1.3 SELECTING AND INSTALLING A LOADER ✖ ✖ ✖ 9 ✖
- 1.4 HANDLING THE LiPo BATTERY ✖ ✖ ✖ 9 ✖

## 1 ORIENTATION

**WELCOME TO THE LUXE® EXPERIENCE.** Please read this section thoroughly before you use your Luxe®, to learn about important safety and operation procedures.

- 2.1 ABOUT COMPRESSED AIR ✖ ✖ ✖ 11 ✖
- 2.2 INSTALLING AN AIR SYSTEM ✖ ✖ ✖ 12 ✖
- 2.3 FEATHERTOUCH ✖ ✖ ✖ 12 ✖

## 2 AIR

**YOUR LUXE® RELIES ON THE POWER** of high-pressure compressed air for fast, quiet and consistent operation. Proper air system handling is extremely important for your safety.

- 3.1 ADJUSTING VELOCITY ✖ ✖ ✖ 14 ✖
- 3.2 DEGASSING THE SYSTEM ✖ ✖ ✖ 14 ✖
- 3.3 ADJUSTING THE TRIGGER ✖ ✖ ✖ 15 ✖
- 3.4 LUXE® BARREL SYSTEM ✖ ✖ ✖ 16 ✖
- 3.5 LiPo RECHARGEABLE BATTERY ✖ ✖ ✖ 17 ✖
- 3.6 REPLACING OR CHARGING THE SPARE BATTERY ✖ ✖ ✖ 17 ✖

## 3 HARDWARE

**THE PHYSICAL ASPECTS OF OPERATING** and adjusting your new Luxe® have been streamlined to get you in the game fast. This section will inform you about trigger and velocity adjustment as well as barrel tuning and battery maintenance.

- 4.1 INTRODUCTION TO PROGRAMMING ✧ ✧ ✧ 18 ✧
- 4.2 NAVIGATION MODES ✧ ✧ ✧ 19 ✧
- 4.3 ADDITIONAL POWER BUTTON FUNCTIONS ✧ ✧ ✧ 19 ✧
- 4.4 RESET TO FACTORY DEFAULTS ✧ ✧ ✧ 19 ✧
- 4.5 USB INTERFACE ✧ ✧ ✧ 19 ✧
- 4.6 FIRING MODES ✧ ✧ ✧ 20 ✧

PULL-OUT SECTION ✧ PROGRAMMING SETTINGS ✧

# 4

## SOFTWARE

**YOUR LUXE® HAS A COMPUTER** on board to provide precise control of its operation. Fortunately you won't need to be a computer expert to use it. Voice menus and a joystick interface put complete control at your fingertips.

- 5.1 LUXE® POWER CORE ✧ ✧ ✧ 22 ✧
- 5.2 BALL DETENTS & VISION EYES ✧ ✧ ✧ 24 ✧

# 5

## MAINTENANCE

**REGULAR MAINTENANCE IS NECESSARY** to keep your Luxe® in peak operating condition. Tool-free access to the Luxe® Power Core and ball detents make this a quick and simple process.

- 6.1 INTRODUCTION ✧ ✧ ✧ 26 ✧
- 6.2 SERVICING THE VERTICAL REGULATOR ✧ ✧ ✧ 28 ✧
- 6.3 BALL DETENT ASSEMBLIES ✧ ✧ ✧ 30 ✧
- 6.4 GRIP FRAME REMOVAL ✧ ✧ ✧ 31 ✧
- 6.5 QUICK-STRIP PLUG DISASSEMBLY ✧ ✧ ✧ 32 ✧
- 6.6 TROUBLESHOOTING ✧ ✧ ✧ 34 ✧
- 6.7 LIMITED WARRANTY ✧ ✧ ✧ 35 ✧

# 6

## ADVANCED MAINTENANCE

**SHOULD ANYTHING GO WRONG** with your marker, your Certified Luxe® Dealer is ready and able to provide complete warranty support without the hassle or wait of shipping your marker. For the more more technically inclined, advanced maintenance guides cover more complex service procedures.

THIS IS NOT A TOY. LUXE® ELECTROPNEUMATIC .68 CALIBER PAINTBALL MARKER. Misuse/careless use may cause serious injury or death. Eye protection in compliance with ASTM Specification F1776, with temple, ear and face protection must be worn by anyone within range of the Luxe. Must be at least



18 years old to purchase, 14 years old to use or operate with adult supervision, 10 years or older to operate on insured paintball fields meeting ASTM-standard F1777-97. Thoroughly read entire operating manual before using. **DLX TECHNOLOGY GROUP,** 979 GOLF COURSE DR #148, ROHNERT PARK, C A . 94928

# ORIENTATION

GET TO KNOW YOUR NEW LUXE® MARKER

## ORIENTATION 1.1 QUICK START

**WELCOME TO THE LUXE® EXPERIENCE.** Follow these simple steps to get your new Luxe® marker up and running in no time.

### STEP ONE CHARGE THE BATTERY (INCLUDED)

**MAKE SURE THE LUXE®'S INTERNAL LITHIUM-POLYMER BATTERY** is fully charged. Remove the rubber grip from your Luxe® and connect the charger to the charging port on the front of the grip frame before plugging the charger into a domestic electrical outlet. The L-shaped slot on the charger's SATA connector only fits in one direction - make sure it is oriented correctly. The included charger will operate on either 110 or 240 volt standard AC power. The LED on the charger will glow solid **red** while charging, and solid **green** when the battery is fully charged. Do not use the included USB/SATA adapter for charging. Reinstall the rubber grip.



### STEP TWO AFFIX THE BARREL BLOCKER (INCLUDED)

**ASSEMBLE THE LUXE® BARREL** (see **HARDWARE 3.4**) and screw it into your Luxe®. Slide the included barrel blocker over the barrel and secure its cord as far back on the Luxe® body as possible, cinching it tight. The barrel blocker is a critical piece of paintball safety equipment—nearly as important as paintball goggles. The barrel blocker must be fully seated on the marker's muzzle and secured in place with its strap any time the marker is stored or handled in an area where people are not properly protected by paintball goggles or paintball field netting.

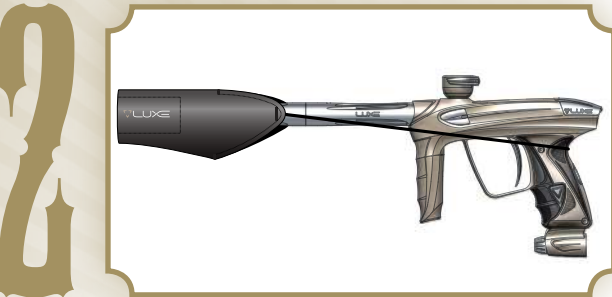

### STEP THREE FILL & INSTALL YOUR AIR TANK (SOLD SEPARATELY)

**YOUR LUXE® IS DESIGNED TO OPERATE PROPERLY** with high pressure compressed air (HPA—also commonly referred to in paintball as *nitrogen* or *nitro*) as its power source. Mount your air system and have it filled, following its manufacturer's directions. If using a screw-in style compressed air system, first turn the Luxe® bottom-line control knob counterclockwise one and a half turns, then screw the air system into the back of the ASA.



4



#### STEP FOUR INSTALL YOUR LOADER (SOLD SEPARATELY)

THE ANTI-CHOP VISION SYSTEM IN YOUR LUXE® will allow it to work with any loader. Best performance and highest rate of fire however, will only be possible with a high performance force-feed loader system. Open the marker's locking feedneck by pulling the lock lever away from the feedneck, then insert the loader and secure it in place by folding the lever back to its locked position.

5

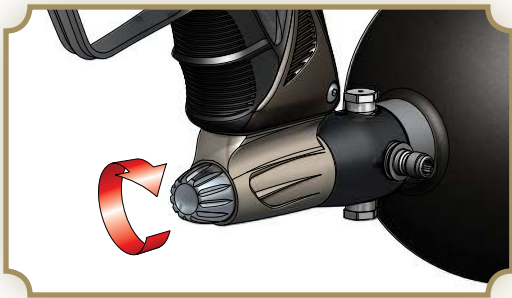

#### STEP FIVE TURN ON AIR

GENTLY GAS UP YOUR LUXE® BY SLOWLY TURNING the air system on or by turning the Luxe® bottom-line control knob clockwise.



A GENTLE RISE IN PRESSURE IS IMPORTANT, AS A SUDDEN BLAST MAY REDUCE THE SERVICE LIFE OF PRESSURE SEALS WITHIN YOUR LUXE®.

The Luxe® bottom-line control knob must be turned off (counterclockwise) before removing screw-in compressed air systems.

6

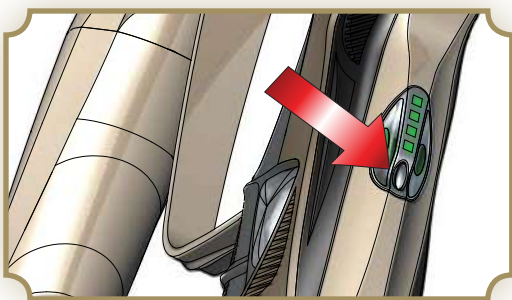

#### STEP SIX POWER ON YOUR LUXE® MARKER

TURN THE MARKER ON BY PRESSING the power button. Turn it off by pressing and holding the power button for 2 seconds. When the Luxe® is on, the right side LED will glow blue, and the left side LED will glow blue to indicate that the breech is empty, or blink blue to indicate that the Luxe® is loaded.



ALTHOUGH THE POWER BUTTON SERVES AS THE LUXE®'S SAFETY SWITCH TO PREVENT ACCIDENTAL FIRING, IT SHOULD NEVER BE RELIED UPON IN PLACE OF A BARREL BLOCKER AND PROPER PAINTBALL EYE PROTECTION.

7

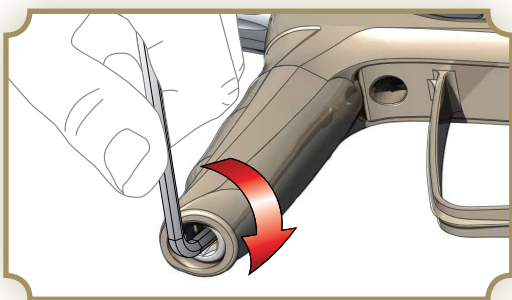

#### STEP SEVEN ADJUST LUXE® VELOCITY

FILL THE HOPPER WITH PAINTBALLS and turn it on. While wearing ASTM compliant paintball goggles, in an area where all bystanders are protected, remove the barrel blocker and fire over a chronograph to measure the velocity. Using a 5/32-inch allen wrench on the adjuster in the bottom of the vertical regulator, turn clockwise to increase velocity/pressure, and counterclockwise to decrease. Take three or four shots after every adjustment to allow the gas pressure inside your Luxe® to stabilize. Adjust until the marker is firing consistently within the limits for the field where you are playing.



NEVER ADJUST YOUR LUXE TO FIRE AT GREATER THAN 300 FEET PER SECOND.



# ORIENTATION

GET TO KNOW YOUR NEW LUXE® MARKER

 **BASIC GUIDE TO LUXE® SPECS & FEATURES**



**MAIN CONTROLS & FEATURES**

- 1 \*\* POWER/LED ARRAY
- 2 \*\* TRIGGER
- 3 \*\* GRIP
- 4 \*\* LUXE® INTEGRATED AIR BOTTOM LINE
- 5 \*\* LUXE® INTEGRATED AIR VERTICAL REGULATOR
- 6 \*\* LUXE® POWER CORE
- 7 \*\* CLAMPING FEEDNECK
- 8 \*\* LUXE® QUICK-SNAP BALL DETENT ASSEMBLY (2)
- 9 \*\* LUXE® 3-PIECE BARREL SYSTEM



WEIGHT  
27.3 oz



OPERATING PRESSURE  
190 psi



OPERATING METHOD  
Electropneumatic



LUBRICANT  
GR33SE



DIMENSIONS  
8.25 x 7 in



POWER SOURCE  
LiPo Rechargeable Battery



ANTI-CHOP SYSTEM  
630nm Vision Break Beam



BARREL THREADS  
Smart Parts



PAINT SIZE  
.68 caliber



PROPELLANT  
Compressed Air



RATE OF FIRE  
Uncapped



FIRING MODES  
15



❧ FIG. 1 ❧

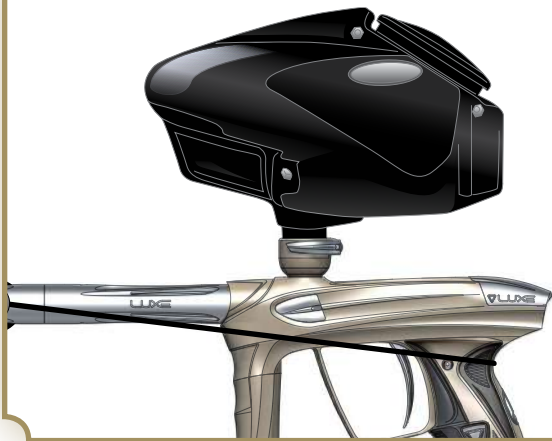

❧ FIG. 2 ❧

## ORIENTATION 1.2 INSTALLING THE BARREL BLOCKER

**THE BARREL BLOCKING DEVICE IS A CRITICAL PIECE** of paintball safety equipment—nearly as important as paintball goggles. The Barrel Blocker serves to protect against accidental discharge of a paintball by catching it before it can cause harm. A Barrel Blocker is included with the Luxe® and must be used every time it is handled in an area where people or property are not properly protected by paintball goggles or paintball field netting. To use the Barrel Blocker simply slip it over the end of the barrel and stretch its cord back over the rear of the Luxe® [FIG. 1.] Use the strap's adjuster to cinch the strap tight, so that the Barrel Blocker can provide protection against accidental discharge of a paintball.



**THE BARREL BLOCKER SHOULD ONLY BE REMOVED WHEN THE LUXE® IS ON A “LIVE” PAINTBALL FIELD AND ALL PERSONS INVOLVED ARE WEARING PROPER PAINTBALL PROTECTION.**

## ORIENTATION 1.3 SELECTING AND INSTALLING A LOADER

**YOUR LUXE® IS A HIGH PERFORMANCE PROFESSIONAL GRADE PAINTBALL MARKER.** Although its Vision anti-chop system will allow it to operate properly with any paintball loader without fear of chopping paint, a high-end forced-feed loader must be used to achieve high rates of fire.

The Luxe® is equipped with a locking feedneck, which allows it to adapt to variance in hopper neck sizes, and to release hoppers quickly when desired, but hold them securely on the field [FIG. 2.] Pulling the lock lever away from the feedneck moves it to the open, or unlocked position. While it is open, the locking mechanism may be adjusted with a 1/8-inch allen wrench opposite the latch pivot. Turning the wrench clockwise will cause the feedneck to grip tighter, while turning it counterclockwise will result in a better fit for larger hopper necks. Place the hopper in the feedneck, and secure it by closing the lever. If the latch is difficult to close, do not force it. Instead, open it fully, then turn the adjuster counter-clockwise and try again until you have adjusted for a perfect fit.



**OVER-TIGHTENING THE FEED NECK CAN CAUSE DAMAGE TO ITS LATCHING MECHANISM. DO NOT OVER-TIGHTEN.**

## ORIENTATION 1.4 HANDLING THE LiPo BATTERY

**INCLUDED WITH YOUR LUXE® IS A RECHARGEABLE LITHIUM-POLYMER BATTERY.** Do not expose the battery to high temperatures, such as strong sunlight or in a vehicle during hot weather. Do not expose the battery to high levels of static electricity. These situations may cause damage, leading to fire or explosion. If the battery leaks, avoid contact with the fluids. In case of eye contact, do not rub. Rinse with clean running water and seek medical attention immediately, or loss of sight may occur. If the battery gives off an odor, generates heat, becomes discolored/deformed or appears abnormal, remove it from any connected device and place in a metal box for immediate disposal. Dispose of used Luxe® batteries through a battery recycling program, as discarded batteries pose a risk of fire or environmental contamination.



**DO NOT IMMERSE THE BATTERY IN LIQUID. STORE IN A COOL, DRY ENVIRONMENT WHEN NOT IN USE. DO NOT REVERSE POSITIVE (+) AND NEGATIVE (-) TERMINALS OR SHORT-CIRCUIT. DO NOT CONNECT THE BATTERY TO AN ELECTRICAL OUTLET. DO NOT STRIKE OR THROW THE BATTERY AGAINST A HARD SURFACE. DO NOT MODIFY, PIERCE, OR SOLDER NEW CONNECTIONS TO THE BATTERY. STORE AND TRANSPORT THE BATTERY IN A CASE WHICH PROTECTS IT FROM DAMAGE OR CONTACT WITH SHARP OR METAL OBJECTS WHEN NOT IN USE.**

# AIR

WHAT YOUR LUXE® NEEDS TO BREATHE

 Basic Guide to THE  
 LUXE® INTEGRATED AIR SYSTEM



## INTEGRATED AIR DESIGN

The Luxe® Integrated Air design means that there are no hoses on the outside or inside of the marker. Hoses and hose fittings are the most common places for leaks to occur in paintball markers. Air passages machined into the Luxe® grip frame and body eliminate these possible failure points, making the Luxe® more reliable.

## VERTICAL REGULATOR

The Integrated Air vertical regulator is the culmination of more than a decade's worth of design, testing and field experience. It delivers the high flow rates and consistent output pressure that the Luxe® needs to compete at the professional level. Its unique bi-directional ASA connection allows it to work with the Luxe® Integrated Air system.

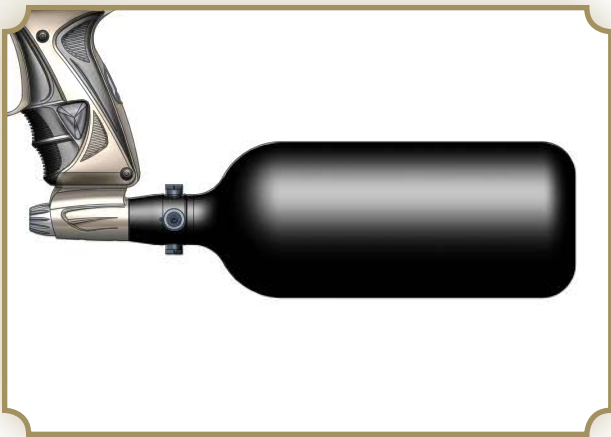

❧ FIG. 1 ❧



❧ FIG. 2 ❧

## AIR 2.1 ABOUT COMPRESSED AIR

**YOUR LUXE® IS DESIGNED TO OPERATE ON HIGH-PRESSURE AIR (HPA)** which is stored in cylinders (tanks) at pressures of up to 3,000 [FIG. 1] or 4,500 psi [FIG. 2.] The storage cylinder, along with the regulator mounted in its neck forms an HPA system. There are two main types of HPA systems, those on which the regulator's output pressure is adjustable, and those for which their regulator is pre-set to deliver a fixed output pressure. HPA systems designed to screw into an ASA are usually pre-set to provide 400 psi (low pressure output) or 800 psi (high pressure output.)



**DO NOT USE CO<sub>2</sub> WITH YOUR LUXE®. USE THE LUXE® ONLY WITH COMPRESSED AIR SYSTEMS FEATURING TWO BURST DISKS, ONE FOR THE HIGH PRESSURE SIDE OF THE REGULATOR, AND AN 1800 PSI RATED BURST DISK FOR THE DOWNSTREAM SIDE OF THE REGULATOR. THE 1800 PSI (ALSO SOMETIMES MARKED 1.8K) PROVIDES CRITICAL PROTECTION IN CASE OF A REGULATOR LEAK, AND ITS ABSENCE MAY CAUSE DAMAGE TO THE LUXE® AND OR SERIOUS INJURY.**

If you are using your Luxe® with an adjustable output compressed air system, it should be set to deliver about 650 psi. The Luxe® vertical regulator can accommodate a wide range of input pressures, and lower them to the marker's operating pressure, so exact adjustment of the air system is not critical, and either low output, or high output pre-set HPA systems may be used. If using a screw-in style air system, the Luxe® on/off bottom-line or similar is recommended, as the on/off control is important for proper set-up and degassing.



**NEVER USE OIL OR ANY PETROLEUM BASED CLEANER OR LUBRICANT IN A COMPRESSED AIR REGULATOR OR CYLINDER. EXPOSURE TO PRESSURIZED AIR INCREASES OIL'S FLAMMABILITY AND CAN CAUSE A SERIOUS SAFETY HAZARD. ONLY USE MANUFACTURER RECOMMENDED LUBRICANTS WITH COMPRESSED AIR SYSTEMS, AND FOLLOW THE MANUFACTURER'S MAINTENANCE AND OPERATION INSTRUCTIONS EXPLICITLY.**

Regardless of the type of air system used, be sure to turn it on by slowly opening its control valve (either on the HPA system, or on/off bottom-line, depending on the configuration) so that the gas pressure in the Luxe® rises gently, rather than jumping to full pressure. Slower pressurization will maximize the service life of the seals and low pressure components in the Luxe®. The Luxe® offers multiple options for mounting compressed air systems. Located on the bottom of the grip frame are a pair of industry standard 10-32 screw holes for air system mounting. Located forward and to the side of these holes is the Luxe® grip integrated gas port. A small o-ring sitting in a recess at the gas port provides an airtight seal.



**DEGAS AND UNLOAD THE LUXE® BEFORE MAKING ANY AIR SYSTEM CHANGES.**



# AIR

WHAT YOUR LUXE® NEEDS TO BREATHE



❧ FIG. 1 ❧



❧ FIG. 2 ❧

## AIR 2.2 INSTALLING AN AIR SYSTEM

**INCLUDED WITH YOUR LUXE® IS A BOTTOM-LINE** style integrated air on/off ASA for use with screw-in style compressed air systems. The grip integrated ASA can be mounted directly to the Luxe® grip frame, or mounted with forward (included) or reverse (optional) grip integrated air rails.

When mounting the bottom-line adapter directly to the grip frame, it must first be disassembled by unscrewing and removing its control knob. Each of the short 10-32 socket head cap screws are inserted in the center slot in the top of the bottom-line adapter [FIG. 1.] then slid to the front or back. A 5/32-inch allen wrench is guided up through holes in the bottom of the adapter to tighten the screws. If needed, the control-knob's o-ring may be lightly lubricated with GR33SE™ before it is reinstalled.

The Air Integrated Rail offers an alternative configuration with a slightly lower and forward placement of the HPA system. A short socket head cap screw is used through the rail's rear hole to secure it to the grip frame [FIG 2.] A long socket head cap screw is slid into the bottom-line's rear mount point while a short socket head cap screw is used in the front, installing with the same procedure as direct-mounting.

When installing a new air system, accessory or mount, the grip must be removed and the battery removed from the Luxe® (see **HARDWARE 3.6.**) Only use mounting screws which will reach through the air system, accessory or mount, and fully engage the screw threads in the grip frame, but not extend into the open space of the grip frame far enough that they interfere with the placement of the battery. Installing mount screws while the battery is removed will ensure that a screw which is too long does not accidentally damage the lithium-polymer battery [FIG. 3.]

In addition to grip integrated air systems, the Luxe® may also use standard hose based air systems and accessories, bypassing the grip integrated air system. Such accessories are mounted the same way, but will require the use of a vertical regulator (see **ADVANCED MAINTENANCE 6.2 for removal instructions**) which accepts input via macroline or steel braided hose and provides output in the range of 170-220 psi [FIG. 4.]



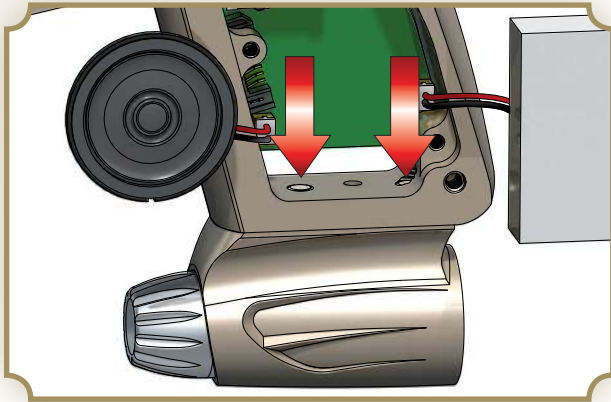

❖ FIG. 3 ❖



❖ FIG. 4 ❖

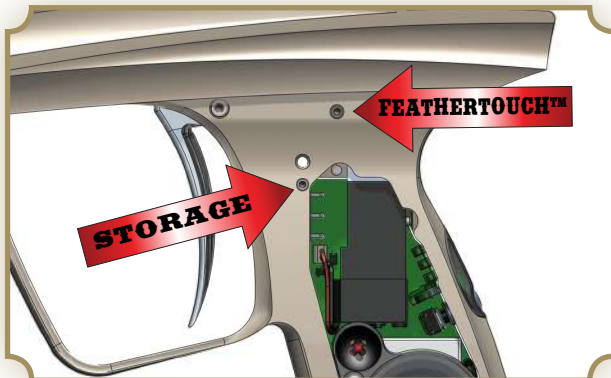

❖ FIG. 5 ❖

## AIR 2.3 FEATHERTOUCH

**YOUR LUXE® IS EQUIPPED WITH A FEATHERTOUCH™ MANIFOLD** allowing for extra-gentle treatment of the most brittle paintballs and an unbeatably smooth firing cycle. The FeatherTouch™ control restricts the flow of gas leaving the forward portion of the Luxe Power Core™. This provides a cushion of air which softens the bolt's forward motion. When using the Luxe™ in FeatherTouch™ mode, it will be necessary to clean and grease the bolt more frequently. Additionally, anti-FSDO adjustments may be necessary for reliable operation. Maintenance is more critical with FeatherTouch™, but top professional players swear by the unmatched feel and fragile paint handling.

To activate FeatherTouch™ the FeatherTouch™ control screw is moved from its storage location to the FeatherTouch™ hole in the Luxe™ solenoid manifold. De-activating FeatherTouch simply requires removing the screw from the manifold.

With the Luxe™ unloaded and degassed, remove the rubber grip, then use a 1/16-inch allen wrench to remove the control screw from its storage position [FIG 5.] The control screw has a small black o-ring on its front. The o-ring may cause the control screw to stick in the threaded hole, requiring a tap on the grip frame to work it loose. Make sure the o-ring is correctly seated on the control screw when reinstalling. When not in use, the control screw should be returned to its threaded storage hole for safekeeping.

Dwell Adjustment will typically need to be increased by 2 milliseconds when FeatherTouch™ is turned on. A dwell setting of 14 milliseconds is ideal..

# HARDWARE

## HOW TO ADJUST ALL MECHANICAL SETTINGS

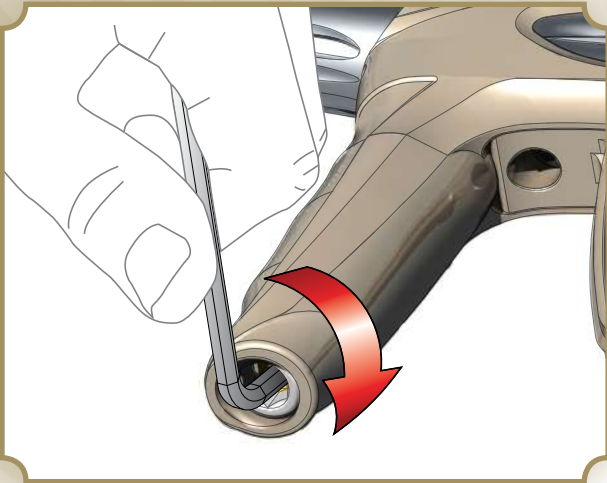

❧ FIG. 1 ❧



❧ FIG. 2 ❧

### HARDWARE 3.1 ADJUSTING VELOCITY

**THE VELOCITY, OR SPEED AT WHICH YOUR LUXE® FIRES** a paintball, must be measured and adjusted to below the paintball field's velocity limit immediately before each day of play (for player safety.) Fill the hopper with paintballs and turn it on.

While wearing ASTM compliant paintball goggles, in an area where all bystanders are protected, remove the barrel blocker and fire over a chronograph to measure the velocity. Using a 5/32-inch allen wrench on the adjuster in the bottom of the Luxe® Vertical Regulator, turn clockwise to increase velocity/pressure [FIG. 1.] and counterclockwise to decrease.

#### ⚠️ WARNING ⚠️

**DO NOT ATTEMPT TO ADJUST THE LUXE® VERTICAL REGULATOR WITH LARGER SIZED ALLEN WRENCHES. THESE ARE USED TO REMOVE AND DISASSEMBLE THE REGULATOR, WHICH MUST NOT BE DONE WHILE IT IS PRESSURIZED.**

Take three or four shots after every adjustment to allow the gas pressure inside the Luxe® to stabilize. Adjust and retest until the marker is firing consistently within the limits for the field where you are playing.

#### ⚠️ WARNING ⚠️

**ALWAYS MEASURE THE VELOCITY OF PAINTBALLS FIRED BY THE LUXE® BEFORE USE, AND NEVER ADJUST TO FIRE ABOVE 300FPS (91.44 M/S.)**

### HARDWARE 3.2 DEGASSING THE SYSTEM

**BEFORE STORAGE, TRANSPORT OR MAINTENANCE**, your marker will need to be unloaded and degassed. In an area where it is safe to shoot and while wearing paintball goggles, loosen the Luxe®'s clamping feedneck and remove the loader. By turning the marker upside down, you can empty any extra paintballs from the feedneck into your hand.

#### ⚠️ WARNING ⚠️

**EVEN WITH ITS GAS SUPPLY TURNED OFF, THE REGULATOR AND GAS PASSAGES IN THE LUXE® WILL CONTAIN ENOUGH PRESSURE TO FIRE MULTIPLE SHOTS UNTIL THE MARKER IS DEGASSED.**

Turn off your HPA system either with its on/off valve, or the on/off valve of a connected bottom-line adapter. Lift the quick-strip latch upward to vent pressure from the Power Core [FIG 2.] As the Power Core is depressurized, it will make a sound similar to a soda can being opened. If you hear the sound of escaping gas for more than a second or two, your HPA system has not been turned off. Turn off your HPA system.



❧ FIG. 3 ❧

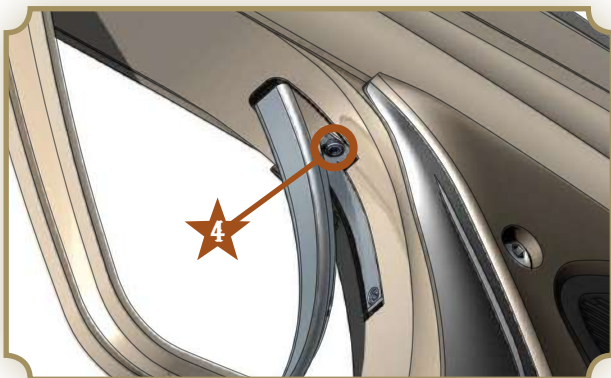

❧ FIG. 4 ❧

- 1 POST-TRAVEL
- 2 PRE-TRAVEL
- 3 ACTIVATION POINT
- 4 RESISTANCE

Once the Luxe® has completely degassed, there will be no more hissing sound. If performing maintenance on the Luxe®, remove the Power Core (see **MAINTENANCE 5.1**) to protect against accidental pressurization—otherwise, re-close the latch. If using a screw-in style HPA system, unscrew the system from the marker's bottom-line ASA. Pay careful attention to make sure the HPA system regulator is unscrewing from the Luxe®'s ASA, rather than the tank unscrewing from its regulator.



### WARNING

**DO NOT LIFT THE QUICK-STRIP LATCH UNTIL THE GAS SUPPLY HAS BEEN TURNED OFF. IF THIS IS DONE ACCIDENTALLY, TURN OFF THE GAS SUPPLY IMMEDIATELY. ATTEMPTING TO CLOSE THE LATCH WHILE THE GAS SUPPLY IS ON MAY RESULT IN O-RING DAMAGE.**

### HARDWARE 3.3 ADJUSTING THE TRIGGER

**YOUR LUXE® IS EQUIPPED WITH A 4-POINT ADJUSTABLE TRIGGER**, providing complete versatility to both the feel and length of the trigger pull. The Luxe® can be adjusted to a super-sensitive hair trigger, though many players find that a slightly longer, and heavier trigger pull is easier to walk to higher rates of fire. Perform trigger adjustments while the Luxe® is unloaded and degassed. Luxe® Training Mode (see **PROGRAMMING PULL-OUT**) can be used to determine the effectiveness of changes in trigger adjustment.

**POST-TRAVEL** The post-travel adjustment sets how far back the trigger can travel, affecting the area of the trigger pull that occurs after the Luxe® fires. Turning the adjustment screw clockwise with an 0.050-inch allen wrench will reduce post-travel, limiting how far back the trigger can swing, while turning counterclockwise will increase it. The post-travel limit must be set to stop the trigger before it is brought to a stop by the trigger switch.

**PRE-TRAVEL** The pre-travel adjustment determines how far forward the trigger can swing, affecting the area of the trigger pull that occurs before the Luxe® fires. Pre-travel is adjusted with an 0.050-inch allen wrench in the pre-travel adjustment screw. Turn clockwise to reduce pre-travel, and counterclockwise to increase.

**ACTIVATION POINT** The activation point setting determines the point in the trigger pull at which the Luxe® trigger switch is activated, signaling the marker to fire. As the screw is turned clockwise with a 0.050-inch allen wrench, it will extend out the back of the trigger, closer to the trigger switch, causing the trigger to be activated earlier in the trigger pull. Due to the limited space to access this adjustment, use of a ball-end allen wrench is advised.



### WARNING

**USE CAUTION WHEN ADJUSTING THE ACTIVATION POINT AND POST-TRAVEL ADJUSTMENT. WHEN PROPERLY ADJUSTED, THE TRIGGER SHOULD COME TO A SOLID STOP AGAINST THE POST TRAVEL ADJUSTMENT SCREW. IF IT COMES TO A SOFTER STOP CAUSED BY THE ACTIVATION POINT ADJUSTMENT SCREW OR REAR OF THE TRIGGER PRESSING AGAINST THE TRIGGER SWITCH, THEN TRIGGER SWITCH AND OR CIRCUIT BOARD DAMAGE MAY RESULT FROM RAPID OR HARD PULLS ON THE TRIGGER.**

**TRIGGER RESISTANCE** Trigger resistance, or the weight of the trigger pull may be adjusted with a 0.050-inch allen wrench in the trigger resistance adjustment screw. Turning clockwise increases pressure on the trigger return magnet, for increased resistance, while turning counterclockwise decreases pressure on the trigger.





# HARDWARE

HOW TO ADJUST ALL MECHANICAL SETTINGS



Basic Guide to the  
LUXE® 3-PIECE  
BARREL SYSTEM

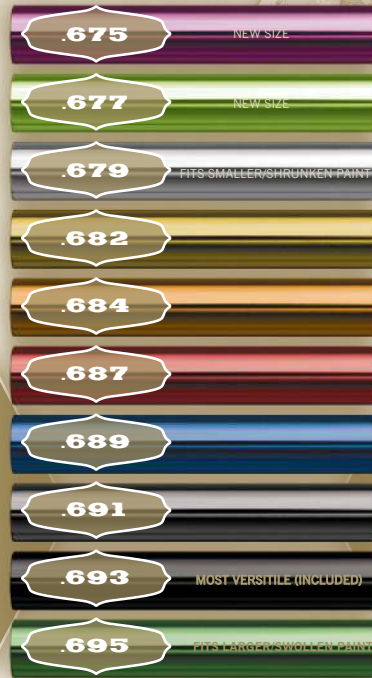

## BACK

ACCEPTS ALL GOG® FRONTS  
AND FREAK® INSERTS



The Luxe® back accepts optional Freak® bore inserts, allowing it to quickly adapt to changing paint conditions.

## FRONT

FITS ANY GOG® BACK, IN ADDITION TO THE STANDARD LUXE® BACK.



Linear pressure compensating ports make every shot quiet and accurate. GOG® barrel compatibility lets you switch to optional fronts to keep pace with changing playing conditions.

## ★ INSERTS ★

AVAILABLE IN 10 COLOR CODED SIZES, FREAK BORE INSERTS CREATE THE PERFECT FIT WITH ANY BRAND OF PAINT.



### HARDWARE 3.4 LUXE® BARREL SYSTEM

**EVEN THE BEST QUALITY PAINTBALLS WILL VARY** in size from one batch to the next and as weather conditions change. Although your Luxe® can work well even with a poor paint to barrel fit, optimal performance will be achieved with a proper fit. The ideal fit between the paintball and the barrel is found when the ball is inserted in the bore and does not slip or roll through to the muzzle on its own, yet can be blown out like a blowgun, using a minimal amount of breath. The barrel can be adapted to fit a wide range of paintball sizes through the use of GOG Paintball® inserts. The .693-inch ID Luxe® bore insert may be removed by sliding it out the back of the barrel, and inserting an appropriate sized Freak® insert in its place. The Luxe® 3-Piece barrel is compatible with all GOG Paintball® multi-piece barrel components providing access to a variety of optional fronts and inserts.





FIG. 1

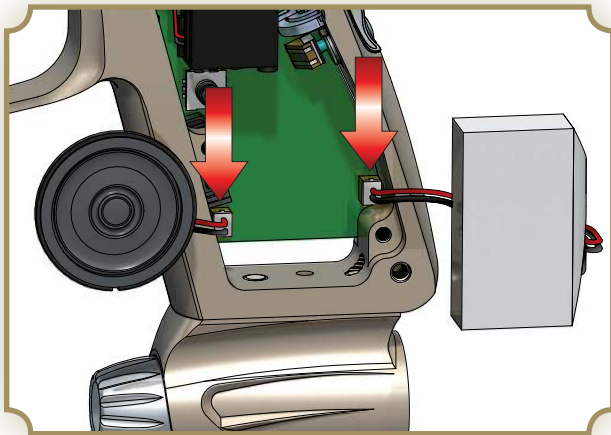

FIG. 2

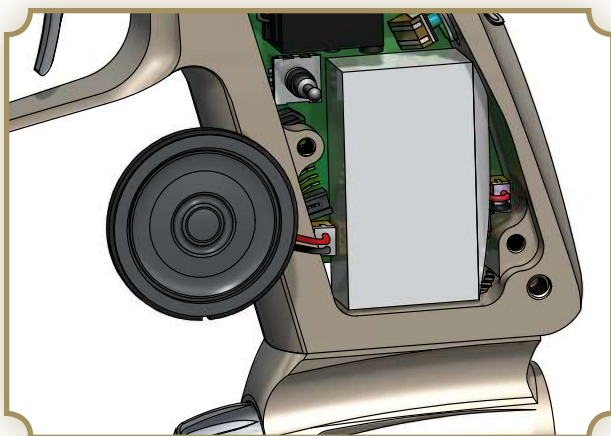

FIG. 3

### HARDWARE 3.5 LiPo RECHARGABLE BATTERY

**YOUR LUXE® IS EQUIPPED WITH** a Lithium-Polymer (LiPo) battery. Lithium-Polymer batteries provide consistent power output in a minimal size and weight, without suffering from charge memory effects.

To charge the Luxe®, use a 5/64-inch allen wrench to remove the four grip screws and completely remove the grip (avoid folding the grip back from one side as this may cause damage.) Simply plug the included charger into the marker's charging port, and plug the adapter into a domestic power outlet. The Luxe® charger is designed for international use, and will operate on standard mains 50 or 60 Hz AC power from 110 to 240 volts. Plug adapters may be required when using the Luxe® outside of the US, Canada or Mexico.

While the Luxe® battery is charging, the charger's LED will glow **red**. It will glow **green** to indicate that the charging cycle is complete. Charge time is approximately 30 minutes. The USB/SATA Luxe USB Interface cable will *not* charge the battery.

### WARNING

**ONLY USE THE LUXE® CHARGER, CIRCUIT BOARD AND GENUINE LUXE® BATTERY. THESE COMPONENTS CONTAIN CRITICAL CHARGE AND DISCHARGE CONTROL CIRCUITS. USE OF AFTER-MARKET ELECTRONIC PARTS MAY RESULT IN FIRE OR EXPLOSION.**

When your Luxe® is turned on, it will display an estimate of the remaining battery charge. This will be displayed momentarily in the bar graph portion of the grip LEDs, followed by another color sequence indicating the marker's current firing mode (see **SOFTWARE 4.3** for LED firing mode sequences) It is important to note that battery discharge rates can be affected by various factors, including temperature, and the indicated charge level is only an estimation of the expected remaining charge life.



### HARDWARE 3.6 REPLACING OR CHARGING THE SPARE BATTERY

**UNLOAD AND DEGAS YOUR LUXE®** following the instructions in this manual. Make sure the Luxe® is turned off and open the left side grip panel with a 5/64-inch allen wrench. Use a 1/16-inch allen wrench to remove the two screws holding the speaker mount and lift it out of the grip frame [FIG. 1.]

Lift out the speaker. Be careful, the flexible cone of the speaker is fragile, and the speaker contains a strong magnet. Do not allow sharp tools like allen wrenches to snap onto the magnet, damaging the speaker cone. Take care not to strain the speaker wires. If necessary, unplug the speaker from the circuit board. When unplugging any component from the circuit board, pull on the connector directly, not its wires. Lift out and unplug the the Lithium-Polymer battery pack.

### WARNING

**DO NOT PLUG A BATTERY INTO THE SPEAKER CONNECTION [FIG.2.] AS CIRCUIT BOARD DAMAGE MAY RESULT.**

Install a charged battery [FIG. 3,] and plug it into the circuit board. Make sure the speaker is plugged in, reinstall the speaker and speaker mount, taking care not to crimp or crush any of the wires, then re-secure the grip panel. The speaker and battery connectors only fit in one direction. If a connector does not slide smoothly onto its pins, try rotating it to determine if it has been reversed. Do not force the connectors.

# SOFTWARE

ALL ELECTRONIC SETTINGS AND FEATURES

**SIMPLY  
 MOVE  
 THE  
 JOYSTICK  
 TO  
 ENTER  
 PROGRAMMING  
 MODE**

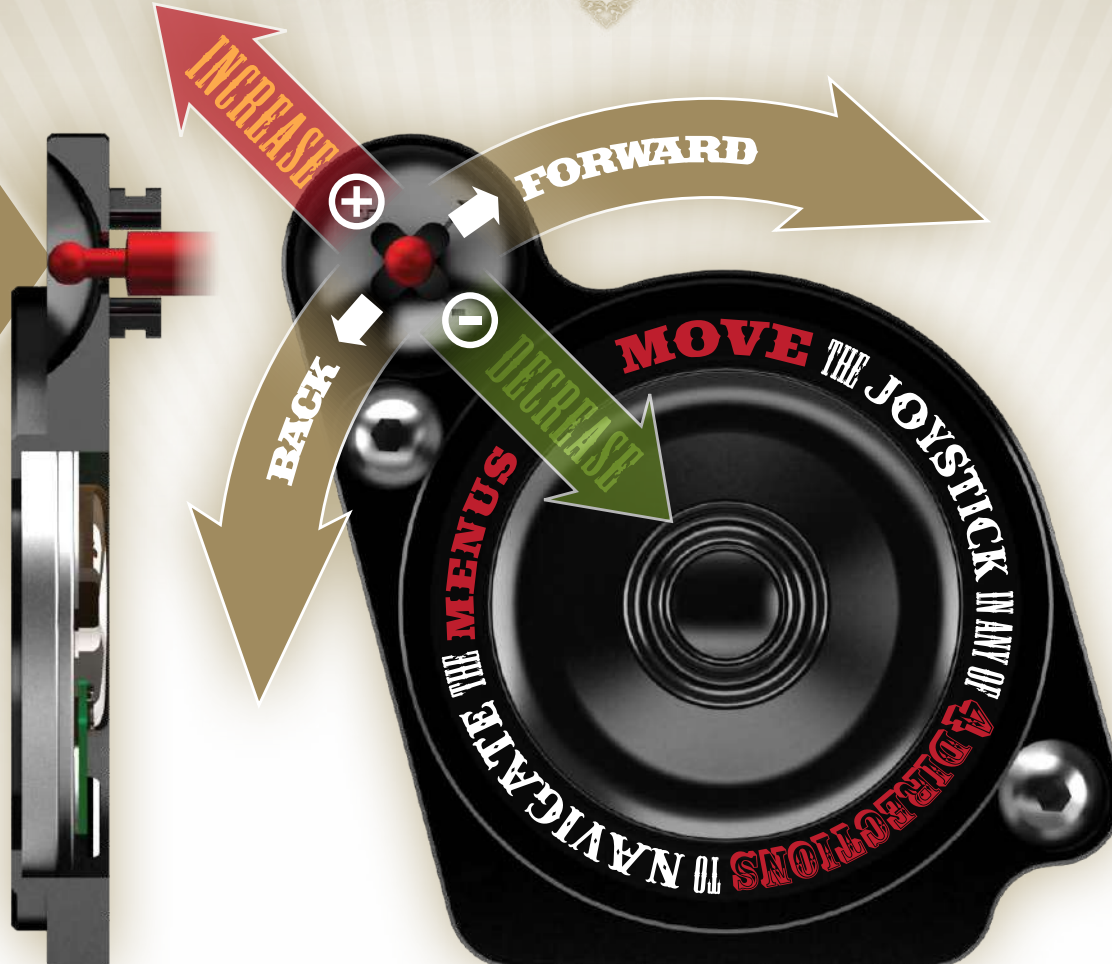

**PRESS  
 THE  
 POWER  
 BUTTON  
 TO**



**EXIT  
 PROGRAMMING  
 MODE**



## SOFTWARE 4.1 INTRODUCTION TO PROGRAMMING

**YOUR LUXE® COMBINES VOICE FEEDBACK** with its LED array to make electronic adjustment simple. All adjustments are performed with the Luxe® turned on, but unloaded and degassed (see **HARDWARE 3.2.**) Adjustments are made with a five-way joystick controller located inside the grip frame. To access it, use a 5/64-inch allen wrench to remove all four grip screws and the grip. The 5-way controller is located next to the Luxe® speaker. It is marked with arrows to indicate the directions it must be moved to scroll through menu items, and with + and - symbols to indicate the directions used for increasing and decreasing setting values.

Luxe® programming mode is entered by pressing down on the 5-way controller or moving it in any direction. This will place the marker in its main menu, which is indicated by the left side LED glowing **red** and the right side LED glowing **green**, and the Luxe® verbally announcing that it is in the main menu.

Push the 5-way controller in the directions of its arrows to scroll through the available settings, each of which is identified by a verbal response and a unique identifier pattern on the LED array. To make a change, find the desired setting, and move the controller to its **+** or **-** position. The Luxe® will display the currently selected value for that sub-menu on the LED array as well as speak the value via the speaker. Changes may be made to the setting by using the **+** or **-** directions on the 5-way controller to increase or decrease the setting. Once a new setting has been chosen (changed dwell setting, new firing mode, etc.) scrolling with the arrows will allow other settings to be checked or changed. Press the power button for approximately 1/4 second to save changes and exit the programming mode.

When programming is complete, re-secure the grip. Because all electronic programming is controlled from within the grip, which is not accessible without tools, the Luxe® can be locked into any tournament or field legal mode required.

## SOFTWARE 4.2 NAVIGATION MODES

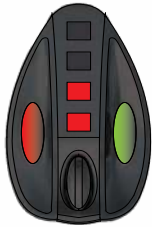

### ⇨ MAIN MENU ⇨

Within the main menu, you may choose which setting you want to check or change. The Main Menu is indicated by the left side LED glowing **red** and the right side LED glowing **green**, and the Luxe® verbally announcing that it is in the main menu. Settings are found in the included **PROGRAMMING PULL-OUT**.

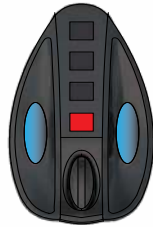

### ⇨ SETTING VALUES ⇨

Some menus are set with numeric values. The Luxe® uses a simple to understand bar-chart method [FIG. 1] for displaying numeric data on its LED array. Both the left and right LEDs will glow **blue** to indicate that a sub-menu's numeric value is being displayed, while center bar graph LEDs illuminate in **red** to show the value.

FIG. 1

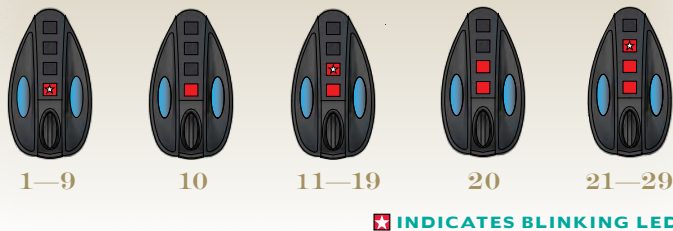

## SOFTWARE 4.4 FACTORY RESET

**PRESSING AND HOLDING THE TRIGGER FOR** approximately 5 seconds while in programming mode will result in the Luxe® resetting all menu items to their factory default values. Factory Reset is confirmed by 3 chirps from the speaker.

## SOFTWARE 4.3 ADDITIONAL POWER BUTTON FUNCTIONS



### ⇨ RATE OF FIRE STATUS CHECK ⇨

The Luxe® is capable of providing feedback on how fast it has been shooting. To determine the fastest rate of fire recently achieved, double-tap the Luxe® power button. The Luxe® will display and announce the rate of fire in balls per second.



### ⇨ VISION CONTROL & BREECH STATUS ⇨

The Luxe® is equipped with a Vision break-beam anti-chop system. The left side LED will glow solid **blue** if the breech is empty, and blink when a paintball is ready to fire. Vision may be deactivated by pressing the power button for approximately one-half second. The Luxe® will announce that Vision has been turned off and the left LED will glow **red**. Pressing the power button again for one-half second will reactivate Luxe® Vision.

## SOFTWARE 4.5 USB INTERFACE

**INCLUDED WITH YOUR LUXE®** is a USB/SATA cable, which can be used to read or adjust the marker's settings, re-flash the circuit board with firmware updates or load new alternative voice sets into your Luxe®. Download the latest version of the Luxe® USB Interface software, software instructions, voice files and firmware at [LuxePaintball.com](http://LuxePaintball.com).

**WARNING:** Do not use the USB/SATA cable with pre-2.0 Luxe® circuit boards as damage may result.



FIRING MODE

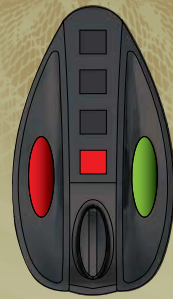

As the name implies, this menu selects one of the Luxe®'s 15 available firing modes, each of which is identified by the Luxe® speaking the mode name and displaying its LED pattern.

- SETTINGS
- ★ SEMI-AUTO ★
  - Capped Semi
  - NXL
  - PSP
  - Millennium
  - CFOA
  - Auto Response
  - Training Mode
  - Burst Mode
  - Full Automatic
  - Rebound 1
  - Rebound 2
  - Rebound 3
  - Rebound 4
  - Rebound 5

DWELL

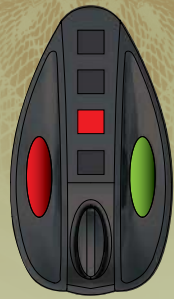

The dwell setting determines how long the the Luxe® sends power to its solenoid valve, which in turn affects how long the bolt remains forward and how much gas is released from the fire chamber to propel each paintball. Dwell is adjustable from 4 to 25 milliseconds in one millisecond increments. The default dwell value is 12 milliseconds, which provides an excellent balance between gas efficiency, speed and reliable operation.

- SETTINGS
- 4 ms
  - 5 ms
  - 6 ms
  - 7 ms
  - 8 ms
  - 9 ms
  - 10 ms
  - 11 ms
  - ★ 12 ms ★
  - 13 ms
  - 14 ms
  - 15 ms
  - 16 ms
  - 17 ms
  - 18 ms
  - up to +25 ms

TRAINING DWELL



This secondary dwell setting determines how long the Luxe® sends power to its solenoid valve when the firing mode is set to Training. This reduced dwell time should be set high enough that a burst of gas can be heard from the solenoid valve, but low enough that the Luxe® will not cycle. Training Dwell is adjustable between 1 and 8 milliseconds.

- SETTINGS
- 1 ms
  - 2 ms
  - 3 ms
  - ★ 4 ms ★
  - 5 ms
  - 6 ms
  - 7 ms
  - 8 ms

SOFTWARE VERSION

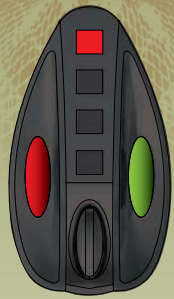

In this menu, selecting + or - on the five-way controller will not make an adjustment. Instead, the Luxe® will respond by announcing the version number of its operating software.

- RESPONSE
- ★ VER. NO. ★

VISION MODE

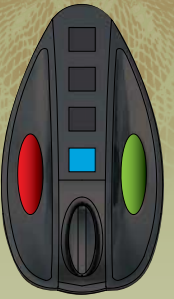

The Vision menu selects the type of anti-chop logic to be used. When set to Vision, the Luxe® will not fire unless a paintball is in the breech, blocking the Vision beam. When set to Delay, the Luxe® will not fire if the trigger is pulled while the breech is empty, but will wait up to a half-second for a ball to drop in place before firing, delivering the maximum possible fire-power from inconsistent loaders. The final setting, Forced Shot will only fire if there is a ball in place, or the trigger is held for more than one second, allowing the player to override the Vision system.

- SETTINGS
- ★ 1 · VISION ★
  - 2 · DELAY
  - 3 · Forced Shot



LOADER DELAY

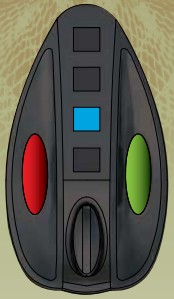

The Vision beam used by the Luxe® to detect a paintball is located slightly above the bottom of the marker's breech. The loader delay determines how long the Luxe® will wait after it detects a paintball, until it fires, allowing the paintball time to complete its journey into the breech. For forced feed loaders less time is necessary than with gravity fed agitating loaders. The loader delay is adjustable between 0 and 15 milliseconds.

- SETTINGS
- 0 ms
  - 1 ms
  - 2 ms
  - ★ 3 ms ★
  - 4 ms
  - 5 ms
  - 6 ms
  - 7 ms
  - 8 ms
  - 9 ms
  - 10 ms
  - 11 ms
  - 12 ms
  - up to 15 ms

B.P.S. LIMIT



This sets the limit of how fast the Luxe® can fire when it is in a capped firing mode. It is set in plain, whole numbers of Balls Per Second. No calculations, charts or conversions are required. The cap value may be set from 11 to 25 bps. Due to variance in electronic components and their performance under varying temperatures, BPS cap settings may vary and should be confirmed with a shot timer.

- SETTINGS
- 4-9 bps
  - 10 bps
  - 11 bps
  - ★ 12 bps ★
  - 13 bps
  - 14 bps
  - 15 bps
  - 16 bps
  - 17 bps
  - 18 bps
  - 19 bps
  - 20 bps
  - 21 bps
  - 22 bps
  - up to +25 bps

B.P.S. FINE ADJUST

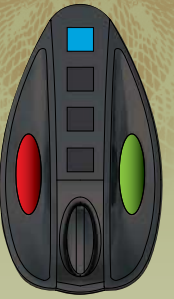

The rate of fire cap may be fine tuned through adjustment of the BPS Fine Adjust menu, which is added to the BPS Limit value. For example, a BPS Limit of 13 combined with a BPS Fine Adjust of 0.25 will result in a 13.25 bps cap to maximize firepower under a 13.3 bps tournament limit. An LED value of 1 represents 0 bps, while 2=0.25 bps, 3=0.5 bps and 4=0.75 bps. Due to variance in electronic components and performance shifts with temperature, rate of fire caps should be confirmed with an external shot timer.

- SETTINGS
- 0 bps
  - ★ 0.25 bps ★
  - 0.5 bps
  - 0.75 bps

BYPASS B.P.S.

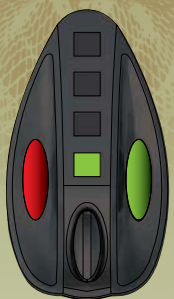

Bypass BPS is an additional rate of fire limit that is imposed when the Vision system detects a fault, such as paint or debris that prevents it from working properly. The bypass BPS setting can be adjusted to ensure that the Luxe® fires slower than its loader's slowest response rate. Bypass BPS is adjustable between 6 and 12 bps.

- SETTINGS
- 6 bps
  - 7 bps
  - 8 bps
  - 9 bps
  - ★ 10 bps ★
  - 11 bps
  - 12 bps

BURST COUNT



This setting selects the number of shots per trigger pull that the Luxe® fires in burst mode. By default the Luxe® will fire a 3-shot burst, though it may be adjusted to 2, 3 or 4 shots.

- SETTINGS
- 2 shots
  - ★ 3 shots ★
  - 4 shots

SHOTS TO ENTER REBOUND SHOTS TO SUSTAIN REBOUND TRIGGER DEBOUNCE MECHANICAL DEBOUNCE FSD COMPENSATION FIRST SHOT DROP TIMER AUTO SHUTDOWN SPEAKER VOLUME DISPLAY TIME LANGUAGE

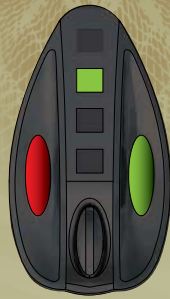

This setting indicates the number of trigger pulls that must be made at the *Shots To Sustain* rate, in order to activate the currently selected rebound mode. Shots To Enter may be adjusted from 1 to 5, and has a default value of 3.



The currently selected rebound mode is activated when the trigger is pulled at this rate for the number of times specified in the *Shots To Enter* setting. The trigger must be pulled repeatedly at this rate or faster to maintain the rebound mode operation. This setting is adjustable between 2 and 10 bps, and has a default value of 5.

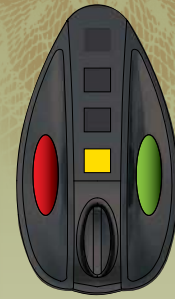

When the Luxe® trigger switch is activated, it will create a series of very fast electrical pulses before a complete connection is made. The Luxe® control software uses the trigger debounce setting to determine the difference between this switch noise, and the solid signal from a completed trigger pull. Trigger signals which last longer than the trigger debounce value are considered to be valid trigger pulls. The debounce value is adjustable between 1 and 25 milliseconds in 1 millisecond increments. The default trigger debounce value is 7 milliseconds.

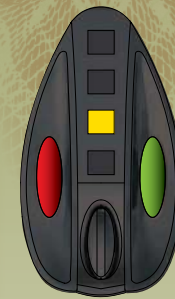

When a paintball marker's trigger is adjusted to an extremely short pull, it is sometimes possible for the vibration of firing to activate the trigger, causing a runaway condition. The mechanical debounce filtering function of the Luxe® control software can be set to discriminate against these mechanical bounces, allowing for extremely sensitive trigger adjustment while meeting tournament trigger requirements. Mechanical debounce is adjustable over a range of 0 (off) to 10, and is off by default.

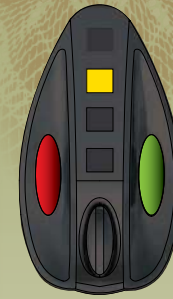

The o-rings in the Luxe® power core, may "set" in position when resting between shots, causing slightly more friction than is seen during rapid firing. In order to overcome this friction, the anti-bolt stick function of the Luxe® control software will slightly increase the dwell time of the first shot in a group. The increased dwell will compensate for the change in friction, keeping velocity more consistent. The standard value for bolt stick adjustment is 7 milliseconds, and it may be adjusted between 0 and 25 milliseconds in one millisecond increments. A setting of 0 turns off first shot drop compensation.

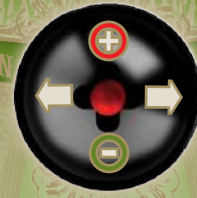

FIRST SHOT DROP TIMER

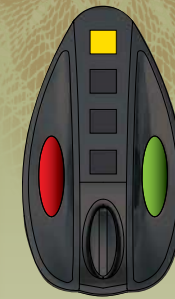

This setting adjusts the amount of time between shots that will activate the anti bolt-stick dwell increase. Time is adjustable between 20 seconds (1) and 100 seconds (5.) The factory setting is 60 seconds (3.)

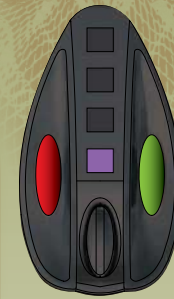

In order to conserve its battery charge, the Luxe® will turn itself off automatically if it is not used for 20 minutes. The length of the auto-off timing may be adjusted from 5 to 30 minutes.



The volume for the Luxe® speaker may be adjusted from 1 (silent) to 3 (high.) Changes in volume will not take effect until exiting programming mode. When speaker volume is set to silent, it will be necessary to use the LED cluster to navigate the programming menu, or change settings with the Luxe® USB Interface software.

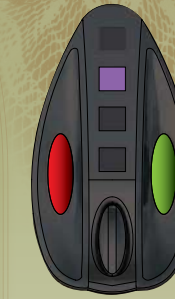

The amount of time which the Luxe® LEDs display information such as currently selected firing mode can be adjusted from 1 to 10 seconds.

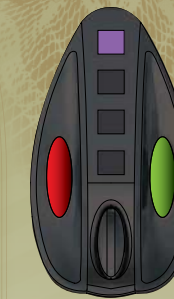

As configured from DLX Technology, the Luxe® speaks English, German, Spanish and Russian. Alternatively, different voice sets may be loaded into voice banks 2, 3 and 4 with the Luxe USB Interface software and cable.

SETTINGS

- 1 shot
- 2 shots
- ★ 3 shots ★
- 4 shots
- 5 shots

SETTINGS

- 2 bps
- 3 bps
- 4 bps
- ★ 5 bps ★
- 6 bps
- 7 bps
- 8 bps
- 9 bps
- 10 bps

SETTINGS

- 1 ms
- 2 ms
- 3 ms
- 4 ms
- 5 ms
- ★ 7 ms ★
- 8 ms
- 9 ms
- 10 ms
- 11 ms
- 12 ms
- 13 ms
- 14 ms
- 15 ms
- up to 25 ms

SETTINGS

- ★ 0 (off) ★
- 1 (lowest)
- 2
- 3
- 4
- 5
- 6
- 7
- 8
- 9
- 10 (highest)

SETTINGS

- 0 ms (off)
- 1-10 ms
- 12 ms
- 13 ms
- 14 ms
- 15 ms
- 16 ms
- 17 ms
- 18 ms
- 19 ms
- ★ 20 ms ★
- 21 ms
- 22 ms
- up to 25 ms

SETTINGS

- 1 (20 s)
- 2 (40 s)
- ★ 3 (60 s) ★
- 4 (80 s)
- 5 (100 s)

SETTINGS

- 5—10 min
- 11 min
- 12 min
- 13 min
- 14 min
- 15 min
- 16 min
- 17 min
- 18 min
- 19 min
- ★ 20 min ★
- 21 min
- 22 min
- 23 min
- 24 min
- up to 30 min

SETTINGS

- 1 (silent)
- 2 (medium)
- ★ 3 (high) ★

SETTINGS

- 1 s
- ★ 2 s ★
- 3 s
- 4 s
- 5 s
- 6 s
- 7 s
- 8 s
- 9 s
- 10 s

SETTINGS

- ★ 1 · ENGLISH ★
- 2 · GERMAN
- 3 · SPANISH
- 4 · RUSSIAN

# SOFTWARE

ALL ELECTRONIC SETTINGS AND FEATURES

## SOFTWARE 4.6 FIRING MODES

EACH OF THE LUXE®'S FIRING MODES IS IDENTIFIED by name, and with a unique pattern on the LED array. The LED identification can also be used when the marker is live by quickly tapping the power button.

### WARNING

WHILE REFERENCES TO PAINTBALL TOURNAMENT LEAGUE RULES ARE ACCURATE AT THE TIME OF THIS WRITING, IT IS NOT UNCOMMON FOR PAINTBALL LEAGUES TO MAKE CHANGES TO THEIR RULES. IN ADDITION TO THE MODE CHOICE, SOME SERIES WILL REQUIRE THE USE OF THE LUXE®'S BPS LIMIT TO LIMIT MAXIMUM RATE OF FIRE. BE SURE TO MAKE YOURSELF FAMILIAR WITH THE RULES OF ANY TOURNAMENT, SCENARIO OR GAME WHERE YOU WILL BE PLAYING, TO BE CERTAIN YOUR LUXE® SETTINGS ARE IN COMPLIANCE.

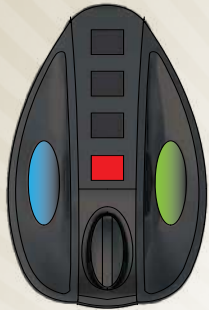

⇒ SEMI-AUTO  
UNCAPPED

This is a traditional semi-automatic firing mode, delivering one shot per complete trigger pull, and it is the factory default setting for the Luxe®. Semi-Automatic mode is uncapped, and the maximum rate of fire that can be achieved in this mode will depend on loader feed rates and Luxe® Dwell settings. Semi-Automatic mode is appropriate for use at most paintball fields and events, including tournaments using NPPL rules.

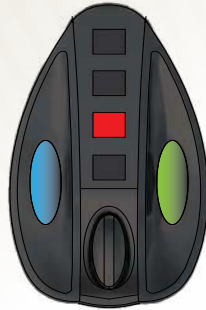

⇒ SEMI-AUTO  
CAPPED

While this mode functions like Semi-Automatic, with one shot per trigger pull, it also takes into account the value set in the BPS (Balls Per Second) Limit. By activating this cap, the Luxe®'s maximum rate of fire can be restricted to meet the demands of special game rules, or to handicap experienced players against those who are new to the sport.

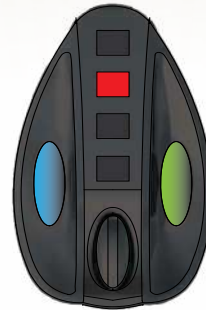

⇒ NXL

NXL mode complies with the rules of the National X-Ball League. Initially this mode acts like semi-automatic. After three trigger pulls in quick succession, it begins operating as a full-automatic, firing repeatedly while the trigger is held down. To prevent accidental multiple-shot firing, NXL mode reverts to semi-automatic style operation after a moment of no trigger activity, ready to begin the cycle again. Maximum rate of fire is capped by the Luxe®'s BPS Limit sub-menu setting. For use in the NXL, the BPS Limit must be set to 13.25 or lower.

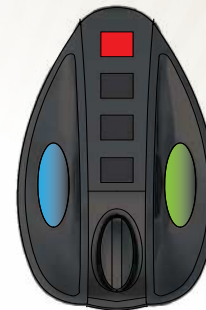

⇒ PSP

For use under the X-Ball rules used in the Paintball Sports Promotions tournament series. Initially, it acts like semi-automatic until three trigger pulls are made in quick succession. At this point PSP mode begins as soon as possible, as long as the user continues to pull the trigger at least once per second. Once the trigger is allowed to rest for more than a second, the cycle begins again with one shot per trigger pull. Maximum rate of fire is capped by the Luxe®'s BPS Limit sub-menu setting. For use at PSP tournaments, the BPS Limit must be set to 13.25 or lower.



⇒ MILLENNIUM

Similar to other series specific modes, the Millennium mode operates as semi-automatic until the user pulls the trigger at a rate of 8 times per second or faster. At this point, the Luxe® will begin firing more than one shot per trigger pull, to maximize firepower, until the user slows below the rate of 8 trigger pulls per second, at which point only one shot is fired per trigger pull. For use in Millennium events, the BPS Limit must be set to 11.9 or lower.



### ↔ CFOA ↔

This mode is meant for use in tournaments of the Carolina Field Owner's Association. CFOA mode fires one shot per trigger pull until three trigger pulls are made at a rate of 5.5 times per second or faster. At this point the Luxe® will fire more than one shot per trigger pull, for increased firepower, until the rate of trigger pulls drops below 5.5 per second, at which point only one shot is fired per trigger pull. For use in CFOA tournaments, the BPS Limit must be set to 13.25 or lower.



### ↔ AUTO RESPONSE ↔

Auto Response is a specialty mode which doubles firepower by firing both when the trigger is pulled and when it is released. Auto Response is affected by the BPS Limit setting.



### ↔ TRAINING MODE ↔

Training Mode will help you learn to walk or pull the Luxe's trigger faster. Training mode operates the same as semi-automatic, but it ignores input from the Vision eye, and activates the Luxe® solenoid valve only long enough to make a noise—but not close the bolt or fire a shot. Although training mode is designed not to fire, paintball goggles and a barrel blocker are required in case paint, grease or debris is dislodged by escaping gas.

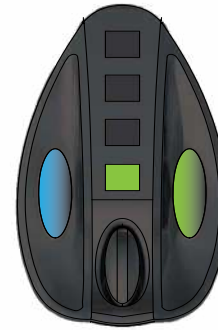

### ↔ BURST MODE ↔

This mode fires a burst of shots when the trigger is pulled and held down. The number of shots in each burst is determined by the burst setting.



### ↔ FULL-AUTO ↔

In Full-Automatic mode, the Luxe® fires repeatedly, while the trigger is pulled and held. The rate of fire delivered will depend on the value of the BPS Limit setting.

---

## ↔ CUSTOM REBOUND MODES ↔

### REBOUND 1–5

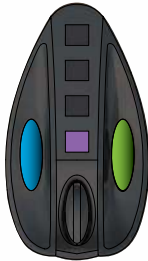

↔ REBOUND 1 ↔

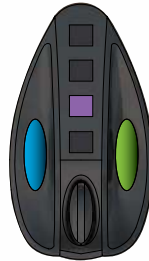

↔ REBOUND 2 ↔

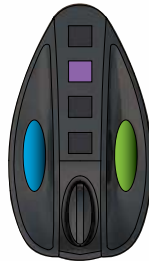

↔ REBOUND 3 ↔

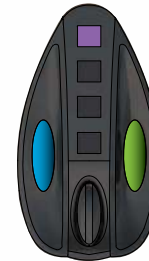

↔ REBOUND 4 ↔

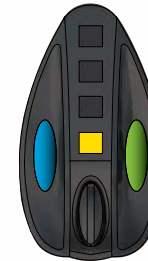

↔ REBOUND 5 ↔

Five user-definable rebound modes allow the Luxe® to operate with ramping built to meet nearly any imaginable rule set. Rebound modes fire as semi-automatic until the set number of activation shots are fired at the minimum sustain rate or faster, at which point the Rebound mode kicks in and fires additional shots, maximizing firepower. Once the rate of trigger pulls drops below the shots to sustain setting, one shot is fired per trigger pull. To configure a Custom Rebound mode, first select that firing mode, then move the joystick to the right arrow enough times to select the sustain rate or activation shots menus, and program their values by scrolling in the + or - directions, and exit the programming menu to save the changes. When changing to a different Custom Rebound mode, that mode's settings for sustain and activation will automatically be loaded into their appropriate menu areas.



# MAINTENANCE

ESSENTIAL STEPS FOR PEAK LUXE® PERFORMANCE



## BASIC GUIDE TO RELEASING THE LUXE® POWER CORE QUICK-STRIP LATCH

THE INNOVATIVE LUXE® POWER CORE CAN BE REMOVED IN SECONDS, NO TOOLS REQUIRED.

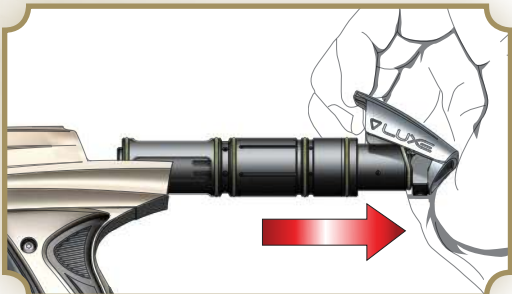

### MAINTENANCE 5.1 LUXE® POWER CORE

**THE HEART OF YOUR LUXE®** is the Luxe® Power Core. This single module comprises both the marker's bolt and exhaust valve system. Its compact, tool-free design makes the Luxe® incredibly fast and simple to maintain. The Luxe® should be disassembled and cleaned any time it shows erratic performance, becomes contaminated with paint, dirt or other debris, or for preventative maintenance after 3 or 4 days of use.

#### STEP ONE UNLOAD AND DEGAS YOUR LUXE®

**UNLOAD AND DEGAS YOUR LUXE®** (see **HARDWARE 3.2.**) Turn off and or remove the gas supply. Remove the barrel then lift the quick-strip latch at the rear of the marker and pull out the Power Core. If the Power Core has not been removed recently it may need to be wiggled slightly to break o-ring friction.

2

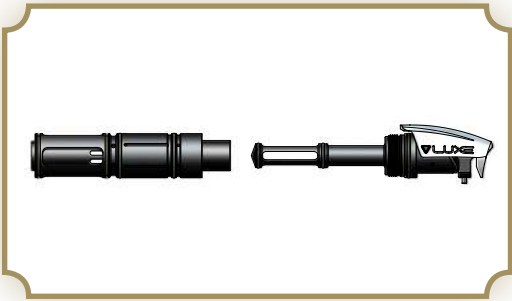

## STEP TWO REMOVE THE FIRE CHAMBER

**BEGIN DISASSEMBLING THE LUXE® POWER CORE** by unscrewing the fire chamber from the quick strip plug, then slide the bolt and fire chamber off of the bolt guide.

3

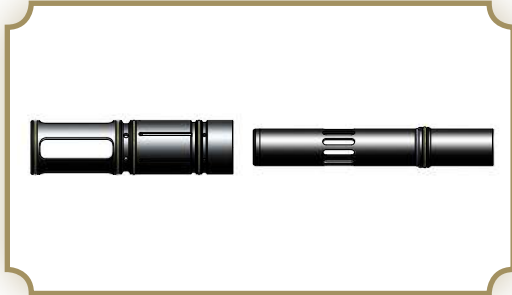

## STEP THREE REMOVE THE BOLT

**SLIDE THE BOLT OUT** of the fire chamber.

4

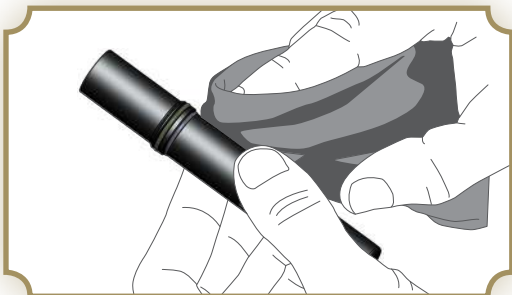

## STEP FOUR CLEAN THE POWER CORE

**USING A CLEAN, SOFT CLOTH**, wipe dirt, paint debris and old grease from all of the Power Core surfaces. Inspect all o-rings and replace any which show significant signs of wear, or have rips, tears or other damage. The windows milled into the side of the fire chamber allow easy access for inspecting internal o-rings and changing them if necessary.

5

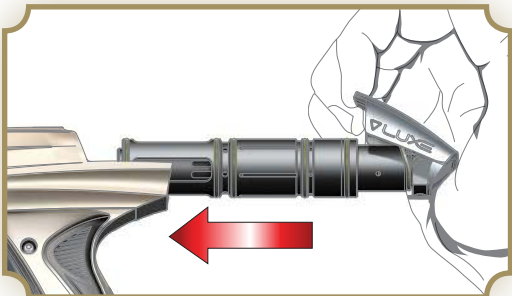

## STEP FIVE LUBRICATE & REINSERT THE POWER CORE

**LUBRICATE ALL O-RINGS WITH A LIGHT COATING** of GR33SE™ marker grease. Take care to ensure that grease is applied to inner o-rings at the front and middle of the fire chamber. Slide the bolt and fire chamber onto the bolt guide, and screw the fire chamber to the quick-strip plug. Insert the Power Core into the rear of the Luxe® body, with the quick strip latch lifted up. Once the Power Core is in position, close the quick strip latch.

# MAINTENANCE

ESSENTIAL STEPS FOR PEAK LUXE® PERFORMANCE



## BASIC GUIDE TO REMOVING THE LUXE® QUICK-SNAP DETENT ASSEMBLIES

THE LUXE® BALL DETENT ASSEMBLIES PROVIDE INSTANT TOOL-FREE ACCESS FOR CLEANING THE BALL DETENTS AND VISION SYSTEM IN THE FIELD.

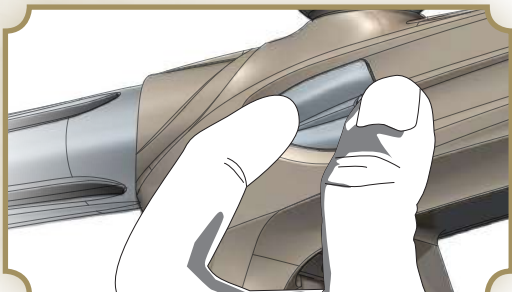

### MAINTENANCE 5.2 BALL DETENTS & VISION EYES

**THE LUXE® QUICK-SNAP BALL DETENT ASSEMBLIES** serve both to prevent double-feeding of paint, and to protect the Vision anti-chop eye system. Their unique magnetic and physical latch systems keeps them secure, while allowing for easy tool-free maintenance. There is a ball detent assembly on each side of the marker, and both should be cleaned and inspected in the same manner.

#### STEP ONE PRESS DETENT ASSEMBLY

**PRESS ON THE FORWARD POINT OF THE BALL DETENT ASSEMBLY** while sliding the Quick-Snap latch forward. This will separate the magnets at the rear, pushing the assembly's back edge out from the Luxe® body.

2

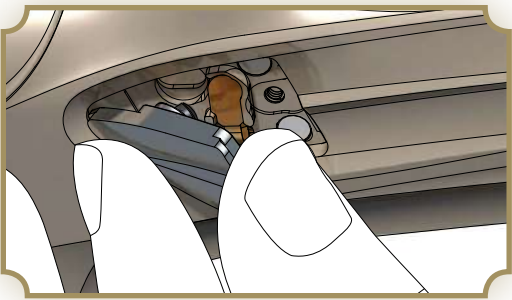

### STEP TWO REMOVE DETENT ASSEMBLY

**GRASP THE BALL DETENT ASSEMBLY** from the rear, and lift outward, away from the Luxe® body.

3

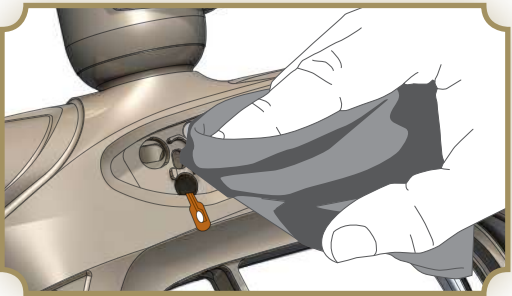

### STEP THREE CLEAN VISION EYE POCKET

**LIFT OUT THE VISION EYE** from its pocket in the Luxe® body. Using a soft cloth or cotton swab, clean any paint, debris or grease from the passage between the eye pocket and the breech, or from the eye itself. If debris buildup is severe, use a cotton swab dampened with rubbing alcohol for cleaning the Vision eye and its pocket and allow them to dry completely before proceeding. Take care not to scratch the Vision eye or strain its flex-strip circuit. Gently re-seat the Vision eye in its pocket, with its emitter or sensor facing inward.

4

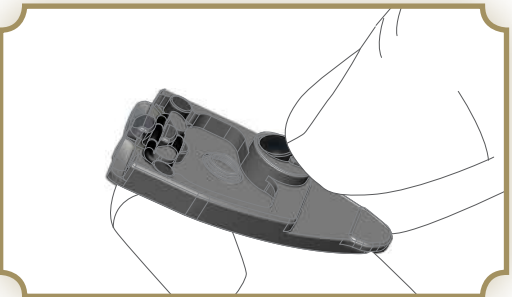

### STEP FOUR INSPECT BALL DETENT PLUNGER

**CLEAN AND INSPECT THE BALL DETENT PLUNGER** in the ball detent assembly. It should move freely when pressed in and released. If the plunger shows significant signs of wear or binding, replace it following the instructions in **ADVANCED MAINTENANCE 6.3**.

5



### STEP FIVE REINSTALL DETENT

**REINSERT THE BALL DETENT ASSEMBLY** by hooking its pointed edge into the front side of its pocket in the Luxe® body. Then angle the rear into place, allowing the rare-earth magnets to grip and secure it in place. Make sure that the latch has clicked into place and in its rearmost position.



# ADVANCED MAINTENANCE

## ADV. MAINTENANCE 6

REPAIR PROCEDURES TO GET YOUR LUXE® BACK IN THE GAME

### ADVANCED MAINTENANCE 6.1 INTRODUCTION

UNDER NORMAL CONDITIONS, YOUR LUXE® should only need the basic maintenance procedures performed. This advanced maintenance section is provided to give you additional familiarity with the Luxe®. If you do not feel comfortable with going beyond regular maintenance, see your Authorized Luxe® dealer for support.





**MAIN LUXE® MARKER COMPONENTS**

- 1 ✪ ✪ CLAMPING FEEDNECK
- 2 ✪ ✪ LUXE® 3-PIECE BARREL SYSTEM
- 3 ✪ ✪ BODY
- 4 ✪ ✪ LUXE® POWER CORE
- 5 ✪ ✪ LUXE® QUICK-SNAP DETENT ASSEMBLIES
- 6 ✪ ✪ VISION EYE RIBBON
- 7 ✪ ✪ SOLENOID VALVE & MANIFOLD
- 8 ✪ ✪ GRIP FRAME
- 9 ✪ ✪ TRIGGER
- 10 ✪ ✪ GRIP
- 11 ✪ ✪ VENTING ON/OFF BOTTOM-LINE
- 12 ✪ ✪ UPPER VERTICAL REGULATOR HOUSING
- 13 ✪ ✪ LOCK SCREWS
- 14 ✪ ✪ PRESSURE CONTROL PISTON
- 15 ✪ ✪ VERTICAL REGULATOR SPRING
- 16 ✪ ✪ LOWER VERTICAL REGULATOR HOUSING
- 17 ✪ ✪ VELOCITY ADJUSTER
- 18 ✪ ✪ VERTICAL REGULATOR COVER
- 19 ✪ ✪ COVER LOCK

# ADVANCED MAINTENANCE

REPAIR PROCEDURES TO GET YOUR LUXE® BACK IN THE GAME

1

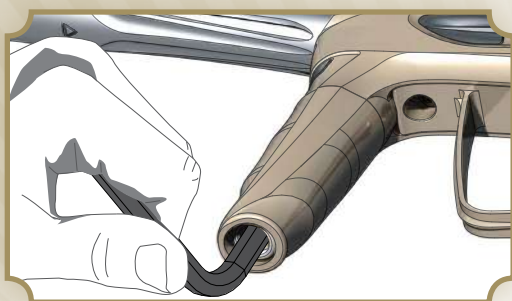

## ADVANCED MAINTENANCE 6.2 SERVICING THE VERTICAL REGULATOR

### WARNING

SERVICE AND ADJUSTMENTS TO THE REGULATOR WILL CAUSE CHANGES IN ITS OUTPUT PRESSURE. RE-ADJUST THE REGULATOR FOR THE CORRECT VELOCITY USING A CHRONOGRAPH AS DESCRIBED IN THE MARKER'S MANUAL.

#### STEP ONE REMOVE REGULATOR FROM ASA

WITH THE LUXE® UNLOADED AND DEGASSED, use a 5/16-inch allen wrench to unscrew the Luxe® vertical regulator from the bi-directional ASA. Hold the regulator cover to prevent it from turning with the regulator. Inspect and clean the o-ring at the top of the regulator, then lubricate it with GR33SE™.

2

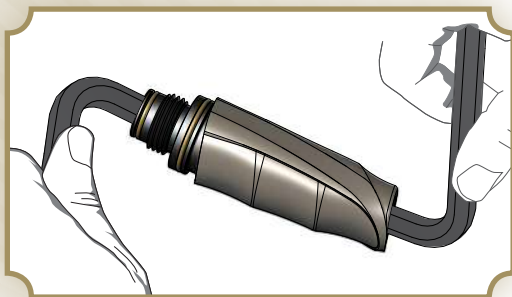

#### STEP TWO REMOVE REGULATOR COVER

INSERT A 3/8-INCH ALLEN WRENCH into the top of the Luxe® regulator, and a 3/8-inch allen wrench into the cover lock at the bottom. Turn the allen wrenches counter-clockwise relative to one another to unscrew the cover lock, and slide the Luxe® regulator out of its cover. Clean and inspect both o-rings on the bi-directional ASA fitting at the top of the regulator, and replace if damaged. Lubricate both o-rings with GR33SE™.

3

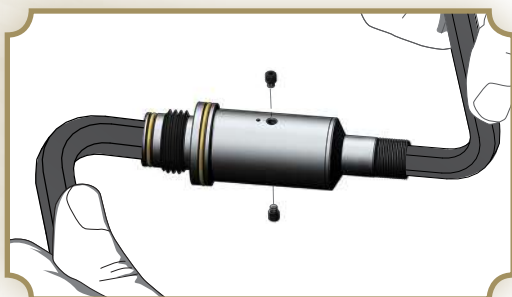

#### STEP THREE DISASSEMBLE REGULATOR HOUSING

USE A 5/64-INCH ALLEN WRENCH to remove the two lock-screws from the sides of the Luxe® regulator. Using a 3/8-inch allen wrench in the top regulator housing, insert a 5/16-inch allen wrench into the lower regulator housing and turn the two counter-clockwise relative to one another. Remove the lower regulator housing from the upper.

4

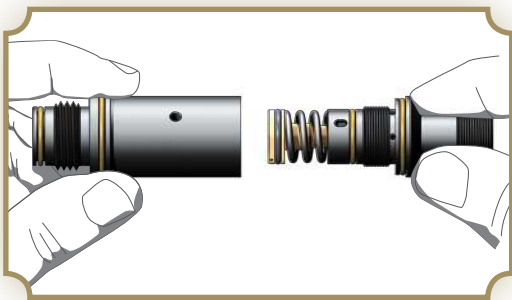

#### STEP FOUR PRESSURE CONTROL PISTON

**THE BRASS PRESSURE CONTROL PISTON** and regulator spring may come out with the lower regulator housing. If they do, the pressure control piston may be pulled out of the lower regulator housing by hand. If the pressure control piston remains in the regulator housing, the regulator spring can be dropped out by tilting the upper regulator housing, and a 5/16-inch allen wrench may be used to push the pressure control piston out from the top.

5

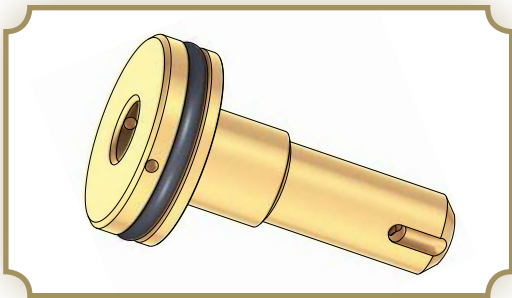

#### STEP FIVE INSPECT SEALS AND REGULATOR HOUSING

**AT THIS LEVEL OF DISASSEMBLY**, the pressure control piston seal and regulator housings may be inspected, and cleaned with a soft cloth or cotton swab. If the piston seal shows signs of excessive wear or damage, it must be replaced. Lightly lubricate all o-rings with GR33SE™ for reassembly. For normal maintenance this is all that must be done.

6



#### STEP SIX VELOCITY ADJUSTER

**THE VELOCITY ADJUSTER SHOULD** only be removed if leaking. Using a narrow pair of snap-ring pliers, remove its lock ring, then unscrew it clockwise (the velocity adjuster is left-hand threaded) out the bottom of the lower regulator housing. Clean, inspect, lubricate and if necessary replace the adjuster's o-rings, then reinstall it with the reverse procedure.



#### **WARNING**

**PARTS OF THE LUXE® INTEGRATED AIR VERTICAL REGULATOR USE LEFT-HANDED THREADS. THESE PARTS MUST BE TURNED COUNTER-CLOCKWISE TO SCREW THEM IN AND CLOCKWISE TO UNSCREW THEM—THE OPPOSITE DIRECTION OF NORMAL SCREWS.**

7

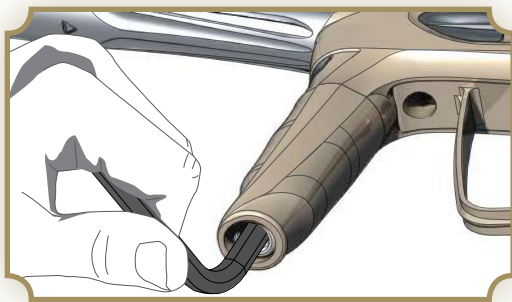

#### STEP SEVEN REASSEMBLE REGULATOR

**REASSEMBLY IS PERFORMED** in the reverse order of disassembly. Insert the pressure control piston into the upper regulator housing, followed by the regulator spring. Screw the lower regulator housing into the upper housing. Look in the lock screw holes to make sure the two halves are aligned properly. Reinstall the lock screws, securing them with blue Loctite® 242. When the housing halves are properly aligned, the lock screws will be able to sit flush with the body. If they do not sit flush, remove them and realign the body halves. Do not over-tighten the lock screws. Using a 5/16-inch allen wrench from the bottom, screw the regulator into the bi-directional ASA then slide the regulator cover in place and secure it with the cover lock.



# ADVANCED MAINTENANCE

## ADV. MAINTENANCE **6**

REPAIR PROCEDURES TO GET YOUR LUXE® BACK IN THE GAME

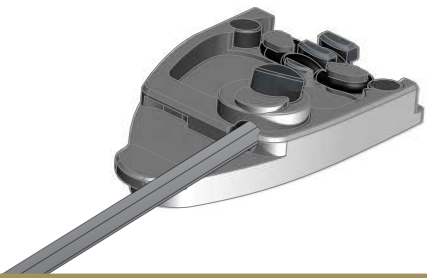

FIG. 1

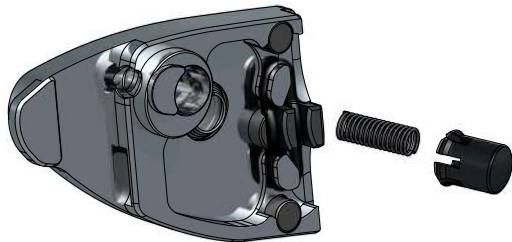

FIG. 2

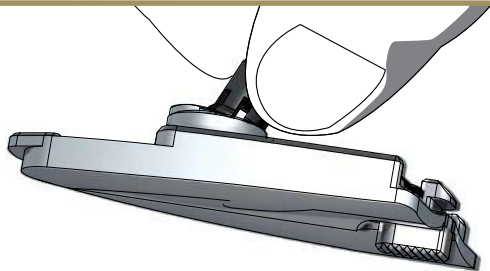

FIG. 3

### ADVANCED MAINTENANCE 6.3 BALL DETENT ASSEMBLIES

**IF THE BALL DETENT PLUNGER OR ITS SPRING** are worn and need replacing, this is a relatively simple task. Remove the ball detent assemblies from the Luxe®, and press their plungers in and out. You should see one of the plunger's fingers moving back and forth across the detent release hole.

Take your 1/16-inch allen wrench, and reach it into the release hole [FIG. 1.] Use the allen wrench to pry outward on the backside of the ball detent plunger. Once the plunger is popped loose, you may pull it out of the ball detent cover with your fingers or a pair of needle-nosed pliers. You will probably damage the ball detent spring in the process, and for this reason it is normal to replace both the plunger and spring at the same time. If you are careful and not put the wrench in any further than is needed to pry against the closest edge of the plunger, you can avoid damage to the ball detent spring. Also check the Detent Assembly tension spring to make sure it is properly seated. Replace if bent or damaged. If, necessary the Quick-Strip latch may be removed for cleaning by first removing its tension o-ring. Replace the o-ring if worn.

Carefully clean the ball detent cover with rubbing alcohol and a cotton swab. Install the new ball detent plunger, with its spring beneath it, into the ball detent cover [FIG. 2.] You will need to pinch the plunger's fingers inward and wiggle it until it presses inside the cover and latches into place [FIG. 3.] Be careful, and make sure you are doing this in a clean work area—if you slip, the spring can jump away from you, and it is much easier to find on a clean work table.

#### WARNING

THE BALL DETENT PLUNGERS ARE MADE OF SELF-LUBRICATING MATERIAL. DO NOT USE GREASE, OIL OR OTHER LUBRICANTS ON THEM.

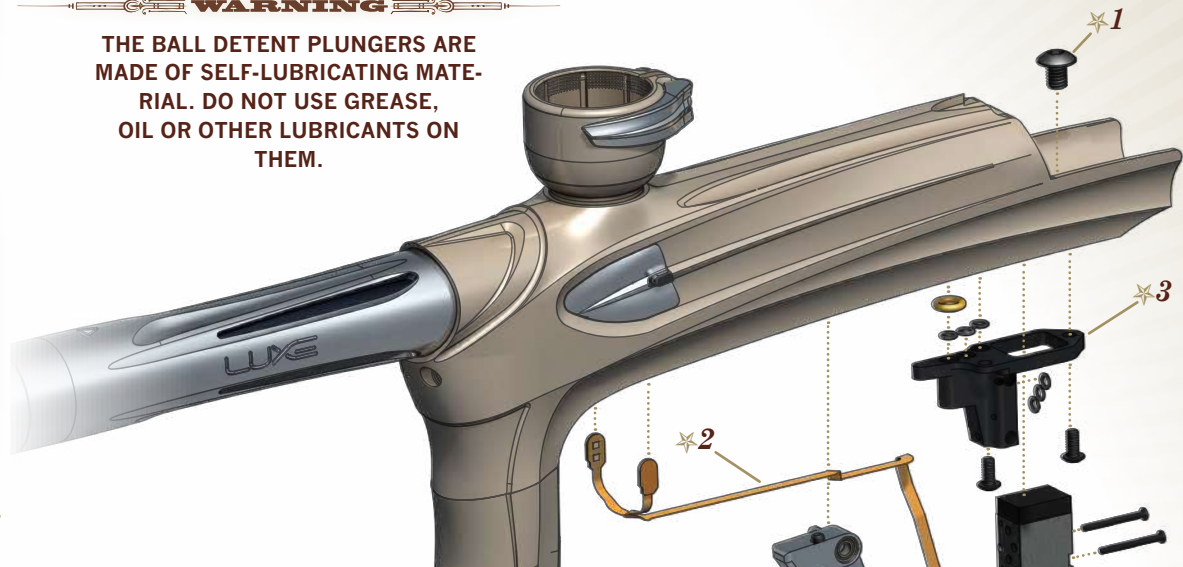

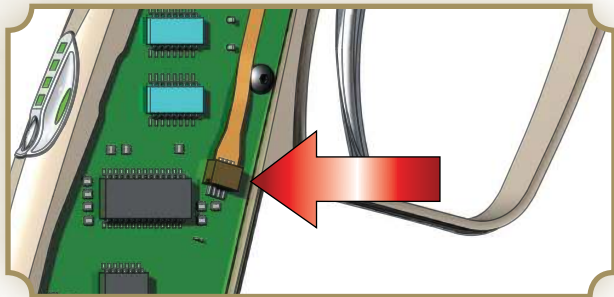

❧ FIG. 4 ❧

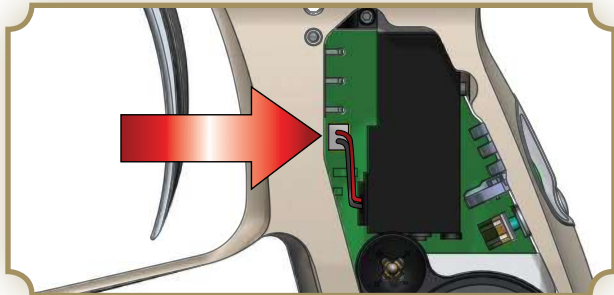

❧ FIG. 5 ❧

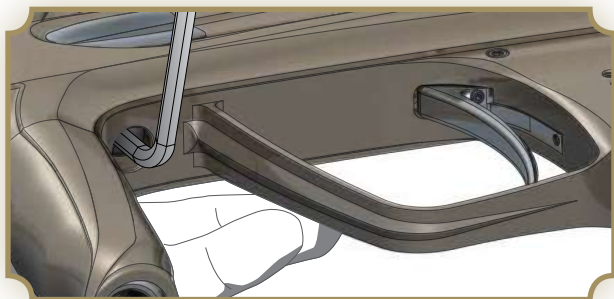

❧ FIG. 6 ❧

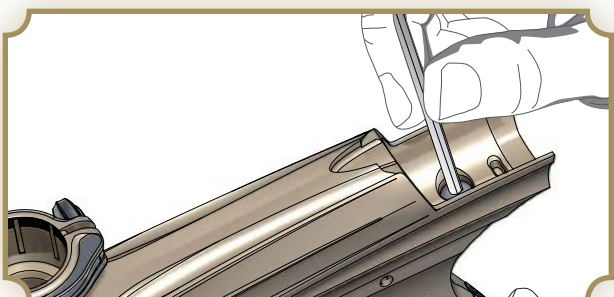

❧ FIG. 7 ❧

#### MAIN GRIP FRAME COMPONENTS

- 1 ❧❧❧ GRIP FRAME SCREWS
- 2 ❧❧❧ VISION EYE STRIP
- 3 ❧❧❧ SOLENOID MANIFOLD
- 4 ❧❧❧ SOLENOID VALVE
- 5 ❧❧❧ TRIGGER
- 6 ❧❧❧ GRIP FRAME



#### ADVANCED MAINTENANCE 6.4 GRIP FRAME REMOVAL

**REMOVING THE LUXE® GRIP FRAME IS NOT** a part of regular maintenance. It should only need to be performed if replacing the anti-chop Vision eyes or solenoid valve. It is recommended that this procedure be performed by a Certified Luxe® Technician, as re-assembly errors may cause leaks in the Integrated Air system or damage to the Luxe® body.

To remove the grip frame first unload and degas the Luxe®. Next use a 5/64-inch allen wrench to remove all four grip screws and the flexible rubber grip. Unplug both the flexible Vision eye ribbon [FIG. 4] and the solenoid valve [FIG. 5.]

Use a 1/8-inch allen wrench to loosen the forward grip frame screw [FIG. 6.] Use the same allen wrench to loosen the rear grip frame screw from the top [FIG. 7.]

While carefully supporting both the Luxe® body and grip frame, completely remove the front and rear grip frame screws. Next, carefully lift the receiver apart from the grip frame. Take care not to snag the solenoid valve connector, and notice how the Vision eye cable is routed through slots in the bottom of the receiver.

With the receiver and grip frame apart, the solenoid valve and solenoid manifold may be removed from the Luxe® receiver by removing their respective screws. Once the solenoid manifold is separated from the receiver, the Vision eye strip is free to be lifted out of its channel in the Luxe® body. With the Ball Detent Assemblies removed (see MAINTENANCE 5.2) the eyes may be lifted out of their pockets and passed down through their openings in the receiver.

Reassembly is performed in the reverse order of disassembly. It is critical to ensure that the solenoid valve wires and Vision eye flex strip are routed properly, and do not become bent or pinched. The sensor and emitter ends of the Vision eye flex strip are keyed with a notched corner to ensure that they are placed on the correct side of the marker. When plugging the Vision flex strip into the Luxe® circuit board, be certain the side with the shiny metal contact surfaces faces outward, away from the circuit board. The forward and rear grip frame screws must be snug, but not overtightened. Over-tightening the solenoid valve or solenoid manifold screws may cause permanent damage.

# ADVANCED MAINTENANCE

REPAIR PROCEDURES TO GET YOUR LUXE® BACK IN THE GAME

## MAIN LUXE® POWER CORE COMPONENTS

- |                              |                               |
|------------------------------|-------------------------------|
| 1 ** QUICK-STRIP LATCH COVER | 6 ** DEGASSING VALVE CORE PIN |
| 2 ** LATCH COVER SCREW       | 7 ** QUICK-STRIP PLUG         |
| 3 ** LATCH RETURN O-RING     | 8 ** FIRING CHAMBER           |
| 4 ** QUICK-STRIP LATCH       | 9 ** BOLT                     |
| 5 ** PIVOT PIN               | 10 ** BOLT GUIDE              |



FIG. 1

### ADVANCED MAINTENANCE 6.5 QUICK-STRIP PLUG DISASSEMBLY

**IT MAY OCCASIONALLY BECOME NECESSARY** to disassemble the Luxe® Power Core's quick strip plug. First, remove and disassemble the Power Core, following the instructions in **MAINTENANCE 5.1**.

Unscrew the bolt guide from the quick strip plug and remove it [FIG. 1.] Lift the quick-strip latch and use a 3-32-inch allen wrench to remove the screw that secures its cover [FIG. 2.] The quick-strip latch cover will then lift off of the latch. You will now be able to see the latch return o-ring. This o-ring does not create a seal, instead it acts as a spring to keep the quick-strip latch closed. It may be removed with an o-ring pick [FIG. 3.] Using a 0.050-inch allen-wrench, unscrew and remove the quick-strip latch pivot pin from the rear of the quick-strip plug [FIG. 4.]



❧ FIG. 2 ❧

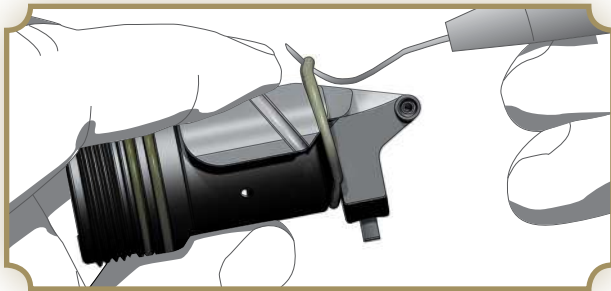

❧ FIG. 3 ❧



❧ FIG. 4 ❧



❧ FIG. 5 ❧

With the pin removed, the latch can be lifted upward, exposing the degassing valve core and its black o-rings [FIG. 5.] If the quick-strip latch was closed while your Luxe® was still connected to a gas supply, and has developed a leak, these are the o-rings likely to have been damaged. To replace, simply remove them with an o-ring pick and slide new o-rings into place, lubricating them lightly with GR33SE™.

The degassing valve core pin also serves as the locking pin which secures the Power Core in the Luxe® body. Inspect the lower end of the degassing valve core pin for signs of wear or bending, its edges should be square and undamaged.

Reassembly of the Power Core is performed in reverse of disassembly. Lower the cleaned and GR33SE™ lubricated degassing valve core down into the quick-strip plug, and align the rear of the quick-strip latch. Slide the quick-strip latch pivot pin into place, and screw it in, taking care not to over-tighten. Use a small amount of Blue Loctite® 242 or equivalent threadlocker (if unavailable, clear nail polish may substitute) on the threads of the latch cover screw and pivot pin. Lift up the latch, set the latch cover in place, and secure it with its screw. Next screw the bolt guide back into the quick-strip plug, and re-assemble the Power Core.



# ADVANCED MAINTENANCE

REPAIR PROCEDURES TO GET YOUR LUXE® BACK IN THE GAME



❧ FIG. 1 ❧

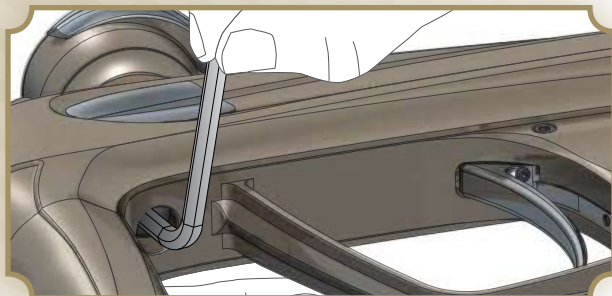

❧ FIG. 2 ❧

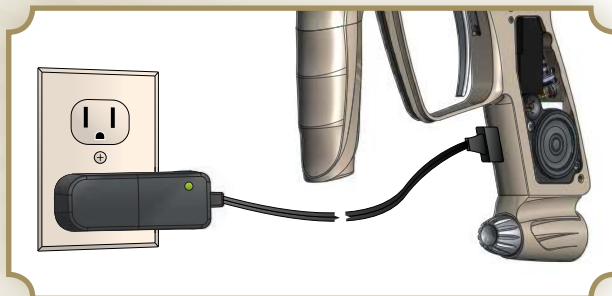

❧ FIG. 3 ❧

## ADVANCED MAINTENANCE 6.6 TROUBLESHOOTING

### PROBLEM

**AFTER ACCIDENTALLY CLOSING THE QUICK-STRIP LATCH, WHILE THE MARKER'S HPA SYSTEM WAS TURNED ON, THE LUXE® HAS A SLOW, CONTINUOUS LEAK.**

### SOLUTION

✧ Disassemble the Quick Strip Plug [FIG. 1,] following the instructions in this manual, and replace the damaged degassing core o-rings (see **ADVANCED MAINTENANCE 6.5.**)

**LUXE® POWER CORE WILL DEGAS, BUT CATCHES ON SOMETHING AND WILL NOT SLIDE OUT.**

✧ If the rear grip frame screw has become loose it may catch on the Power Core. With the Luxe® unloaded and degassed, loosen the front grip frame screw [FIG. 2,] two or three turns, then pull the grip frame away from the body, creating a slight gap between them. This will pull the rear grip frame screw down and out of the way, allowing for removal of the Power Core. Re-tighten both grip frame screws.

✧ ✧ If this is a recurring problem, you may wish to secure the rear grip frame screw with a small amount of Loctite® 242 (blue) or equivalent thread-locking compound.

**LUXE® WILL NOT TURN ON WHEN POWER BUTTON IS PRESSED.**

✧ Recharge the Luxe® battery [FIG. 3] following the instructions in this manual (see **HARDWARE 3.6.**)

✧ ✧ Following the battery replacement instructions (see **HARDWARE 3.6.**) ensure that the battery is installed and connected securely to the Luxe® circuit board.

**FIRST SHOT FIRED HAS LOW VELOCITY BUT STABILIZES WITH FOLLOWING SHOTS (FIRST SHOT DROP-OFF.)**

✧ Clean, inspect and lubricate the Luxe® Power Core (see **MAINTENANCE 5.1.**)

✧ ✧ Increase FSD Compensation setting (see **the PROGRAMMING PULL-OUT**)

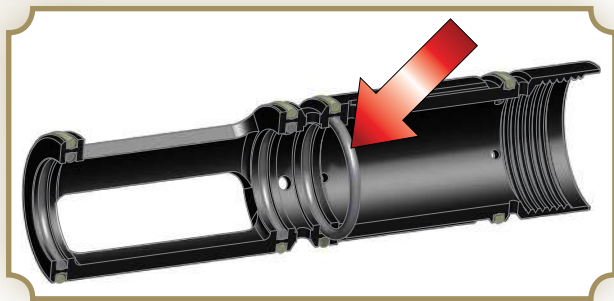

❧ FIG. 4 ❧

**LUXE® WILL TURN ON AND MAKES PUFFING SOUND WHEN TRIGGER PULLED BUT WILL NOT FIRE.**

- ✧ Make sure that the Luxe® is not set into the Training firing mode (see **SOFTWARE 4.1 & 4.5.**)
- ✧ ✧ Make sure that the Dwell setting is set to the default value or higher (see the **PROGRAMMING PULL-OUT.**)
- ✧ ✧ ✧ Clean the Power Core, and replace and lubricate the fire chamber's inner o-rings. (see **MAINTENANCE 5.1.**)
- ✧ ✧ ✧ ✧ Replace the o-ring indicated in **[FIG 4.]**

**VELOCITY DROPS OFF DURING RAPID FIRE.**

- ✧ Clean, inspect and lubricate the Luxe® Power Core (see **MAINTENANCE 5.1.**)

### **ADVANCED MAINTENANCE 6.7 LIMITED WARRANTY**

**WARRANTY SUPPORT AND SERVICE FOR DLX TECHNOLOGY GROUP PRODUCTS IS PROVIDED BY FACTORY TRAINED SERVICE TECHNICIANS AT LUXE® AUTHORIZED DEALERS.**

**DLX TECHNOLOGY GROUP WARRANTS FOR ONE (1) YEAR TO INITIAL RETAIL PURCHASER THAT THE PAINTBALL MARKER AND REGULATOR COMPONENTS ARE FREE FROM DEFECTS IN MATERIALS AND WORKMANSHIP. THE VALVE ASSEMBLY AND SOLENOID ARE WARRANTED FOR SIX (6) MONTHS. DISPOSABLE PARTS (BATTERIES, O-RINGS, SEALS, ETC.) ARE NOT WARRANTED. ELECTRONIC COMPONENTS ARE WARRANTED FOR AN ADDITIONAL SIX MONTHS WITHOUT THE INCLUSION OF INSTALLATION AND LABOR CHARGES.**

**THIS WARRANTY DOES NOT COVER SURFACE DAMAGES (SCRATCHES AND NICKS), MISUSE, IMPROPER DISASSEMBLY AND RE-ASSEMBLY, ATTEMPTS MADE TO DRILL HOLES OR REMOVE METAL FROM THE EXTERNAL SURFACES WHICH COULD DEGRADE PERFORMANCE AND REDUCE PRESSURE SAFETY FACTORS OF THE MARKER. DO NOT MAKE CHANGES TO THE BASIC MARKER PARTS WITHOUT WRITTEN APPROVAL. THE ONLY AUTHORIZED LUBRICANT FOR THE MARKER IS GR33SE™ LUBRICANT. USE OF ANY OTHER LUBRICANT COULD RESULT IN VOIDING YOUR WARRANTY. PAINTBALL MARKERS ARE NON-REFUNDABLE.**

**THIS WARRANTY IS LIMITED TO REPAIR OR REPLACEMENT OF DEFECTIVE PARTS WITH THE CUSTOMER RESPONSIBLE FOR TRANSPORTING THE PRODUCT TO AND FROM THE LUXE® AUTHORIZED DEALER. THIS WARRANTY IS EFFECTIVE ONLY IF THE CUSTOMER RETURNS THE WARRANTY REGISTRATION CARD ENCLOSED WITH THE MARKER. THE WARRANTY IS NON-TRANSFERABLE. DO NOT ATTEMPT TO ALTER THE TRIGGER ASSEMBLY IN ANY WAY, AS THIS WILL VOID YOUR DLX TECHNOLOGY GROUP WARRANTY. TRIGGER ALTERATION OF ANY KIND MAY RESULT IN SERIOUS INJURY.**



A series of horizontal dotted lines spanning the width of the page, intended for writing notes.

.....

.....

.....

.....

.....

.....

.....

.....

.....

.....

.....

.....

.....

.....

.....

.....

.....

.....

.....

.....

.....

.....

.....

.....





A series of horizontal dotted lines for writing notes, spanning the width of the page.

.....

.....

.....

.....

.....

.....

.....

.....

.....

.....

.....

.....

.....

.....

.....

.....

.....

.....

.....

.....

.....

.....

.....

